

HC-STA-B24PT-BWSC-LT-M32-ELCAL - Connector set



1416351

<https://www.phoenixcontact.com/us/products/1416351>

Please be informed that the data shown in this PDF document is generated from our online catalog. Please find the complete data in the user documentation. Our general terms of use for downloads are valid.



Connector set, number of positions: 24, connection method: Push-in connection, connection cross section: AWG 26- 14

Commercial data

Item number	1416351
Packing unit	1 pc
Minimum order quantity	1 pc
Sales key	BF63
Product key	BF7AFX
Catalog page	Page 638 (C-2-2017)
GTIN	4055626071220
Weight per piece (including packing)	769.7 g
Weight per piece (excluding packing)	769 g
Customs tariff number	85366990
Country of origin	CN

HC-STA-B24PT-BWSC-LT-M32-ELCAL - Connector set



1416351

<https://www.phoenixcontact.com/us/products/1416351>

Set consists of

HC-B24-I-PT-F - Contact insert

1407735

<https://www.phoenixcontact.com/us/products/1407735>



Contact insert, number of positions: 24+PE, size: B24, number of connections per position: 1, Socket, Push-in connection, 500 V, 16 A, 0.14 mm² ... 2.5 mm², application: Power

HC-B24-I-PT-M - Contact insert

1407736

<https://www.phoenixcontact.com/us/products/1407736>

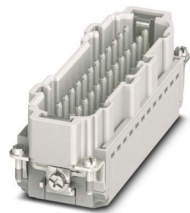

Contact insert, number of positions: 24+PE, size: B24, number of connections per position: 1, Pin, Push-in connection, 500 V, 16 A, 0.14 mm² ... 2.5 mm², application: Power

HC-STA-B24PT-BWSC-LT-M32-ELCAL - Connector set



1416351

<https://www.phoenixcontact.com/us/products/1416351>

HC-STA-B24-BWSC-ELC-AL - Housing

1411330

<https://www.phoenixcontact.com/us/products/1411330>



Panel mounting base B24, with single locking latch, material: Die-cast aluminum, salt water resistant, protective cover material: PC, height: 30.5 mm, cable gland: none, protective cover: yes, Standard, with flat gasket

HC-STA-B24-HLFS-1TTM32-EL-AL - Housing

1412789

<https://www.phoenixcontact.com/us/products/1412789>



Sleeve housing B24, for single locking latch, material: Die-cast aluminum, salt water resistant, cable outlets: 1, straight, 1x M32, height: 60 mm, cable gland: none, Standard

HC-STA-B24PT-BWSC-LT-M32-ELCAL - Connector set



1416351

<https://www.phoenixcontact.com/us/products/1416351>

G-INS-M32-M68N-NNES-S - Cable gland

1411166

<https://www.phoenixcontact.com/us/products/1411166>



Cable gland, material for screw connection: Brass, nickel-plated, application: Standard, external cable diameter 15 mm ... 21 mm, shielding: no, connecting thread: M32 x 1.5, color: silver, with O-ring

HC-STA-B24PT-BWSC-LT-M32-ELCAL - Connector set



1416351

<https://www.phoenixcontact.com/us/products/1416351>

Technical data

Product properties

Product type	Connector set
Housing type	Complete housing
Series	HC-B
Application	Standard
Type	B24
Number of positions	24
Connection profile	24+PE
No. of cable outlets	1
Seal present	yes
Protective cover	yes

Insulation characteristics

Overvoltage category	III
Degree of pollution	3

Electrical properties

Rated voltage (III/3)	500 V
Rated surge voltage	6 kV
Rated current	16 A

Connection data

Connection method	Push-in connection
Connection technology	Push-in connection
Conductor cross section	0.14 mm ² ... 2.5 mm ² (with ferrule) 0.14 mm ² ... 2.5 mm ² (with ferrule)
Connection cross section AWG	26 ... 14
Stripping length	8 mm ... 10 mm

Dimensions

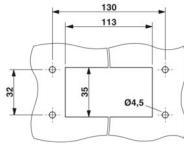
Dimensional drawing	
Width	53 mm
Height	90.5 mm
Length	140.5 mm
Drill hole distance, horizontal	130 mm
Drill hole distance, vertical	32 mm
Hole diameter	4.5 mm

HC-STA-B24PT-BWSC-LT-M32-ELCAL - Connector set



1416351

<https://www.phoenixcontact.com/us/products/1416351>

Installation dimensions

Width of the assembly cutout	35 mm
Length of the assembly cutout	113 mm

Material specifications

Material Housing	Die-cast aluminum, saltwater-resistant
Material Protective cover	PA
Flammability rating according to UL 94	V0
Seal material Profile gasket	NBR
Seal material Flat gasket	NBR
Contact material	Copper alloy
Contact surface material	Ag
Contact carrier material	PC
Locking latch material	PA

Cable/line

External cable diameter	15 mm ... 21 mm
	17 mm ... 21 mm (for UL 514 B)

Mechanical properties

Mechanical data

Locking type	Latch
Insertion/withdrawal cycles	≥ 500

Environmental and real-life conditions

Ambient conditions

Degree of protection	IP66
	IP67
Impact strength	IK08
Ambient temperature (operation)	-40 °C ... 100 °C

Mounting

Mounting type	Screw mounting
Assembly note	Coding also using the CP-HC (1686478) coding profiles. HC-B6.. / HC-B10..for two coding profiles. HC-B16.. / HC-B24..for four coding profiles.
	Connectors may only be operated when there is no load/the power is switched off. Can be used for solid wires and stranded wires with ferrule.

HC-STA-B24PT-BWSC-LT-M32-ELCAL - Connector set



1416351

<https://www.phoenixcontact.com/us/products/1416351>

Drawings

Dimensional drawing

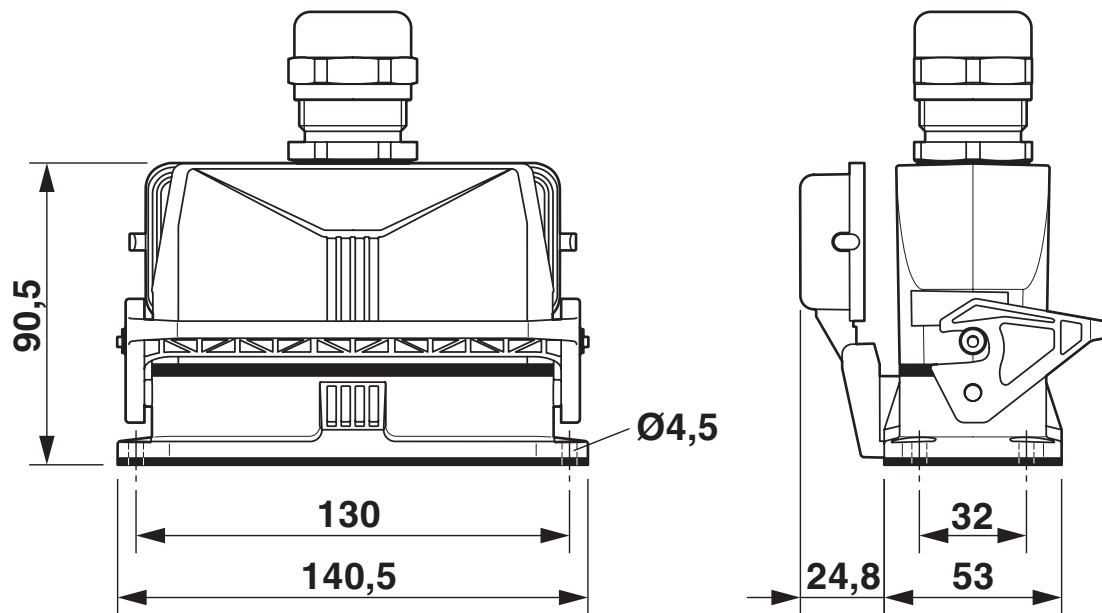

Dimensional drawing

Diagram

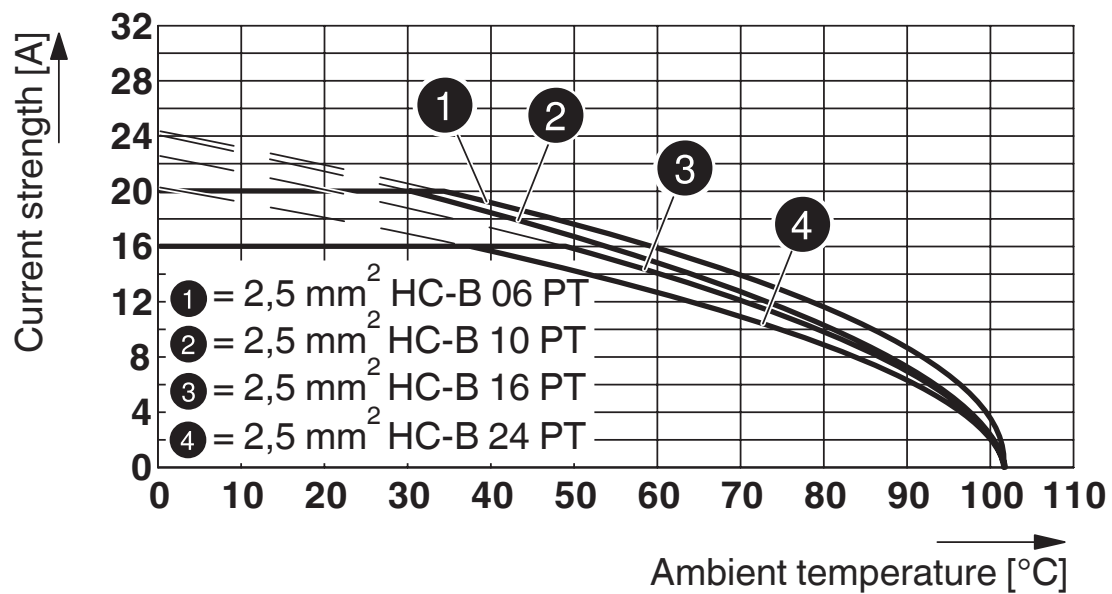

Derating diagram

HC-STA-B24PT-BWSC-LT-M32-ELCAL - Connector set



1416351

<https://www.phoenixcontact.com/us/products/1416351>

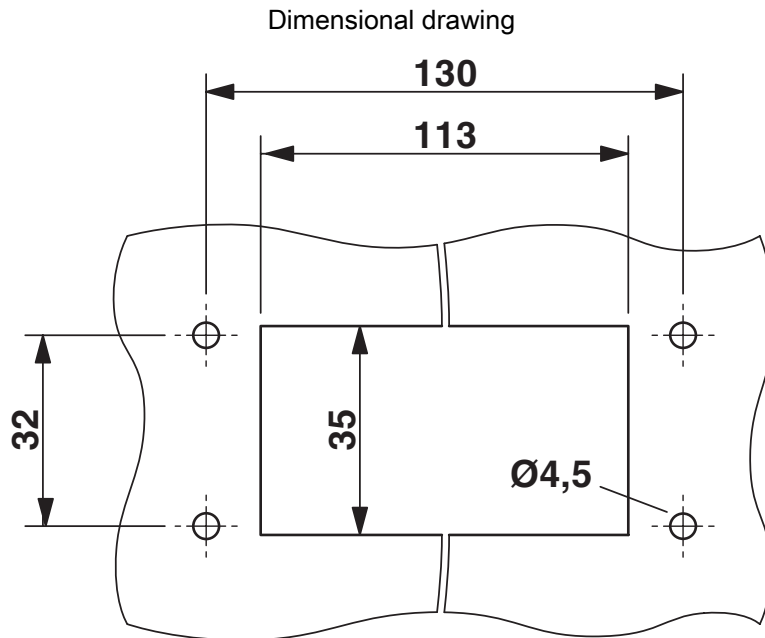

Mounting cutout

HC-STA-B24PT-BWSC-LT-M32-ELCAL - Connector set



1416351

<https://www.phoenixcontact.com/us/products/1416351>

Schematic diagram

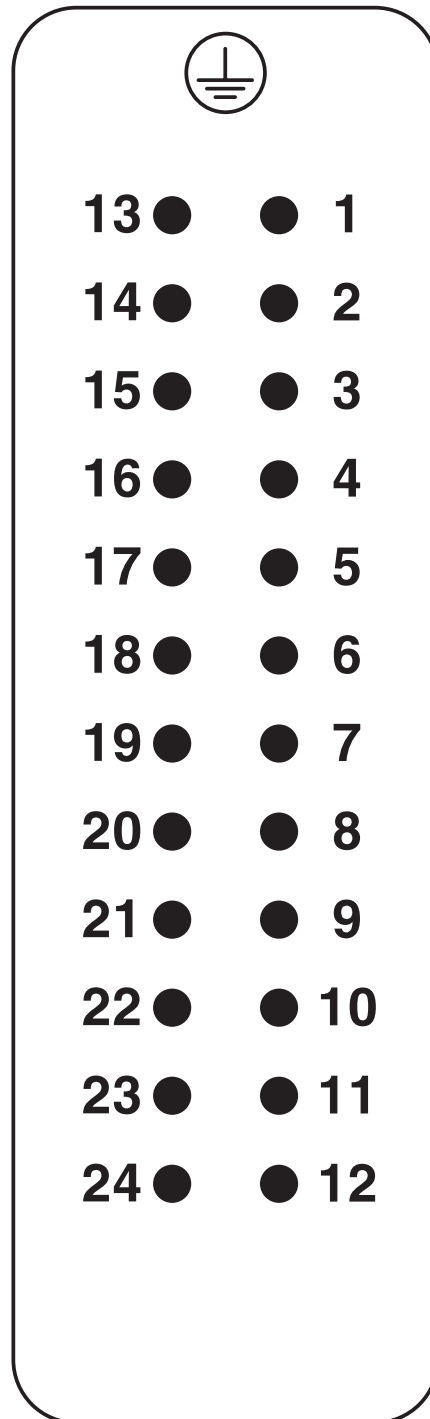

Pin assignment, connection side, pin

HC-STA-B24PT-BWSC-LT-M32-ELCAL - Connector set



1416351

<https://www.phoenixcontact.com/us/products/1416351>

Schematic diagram

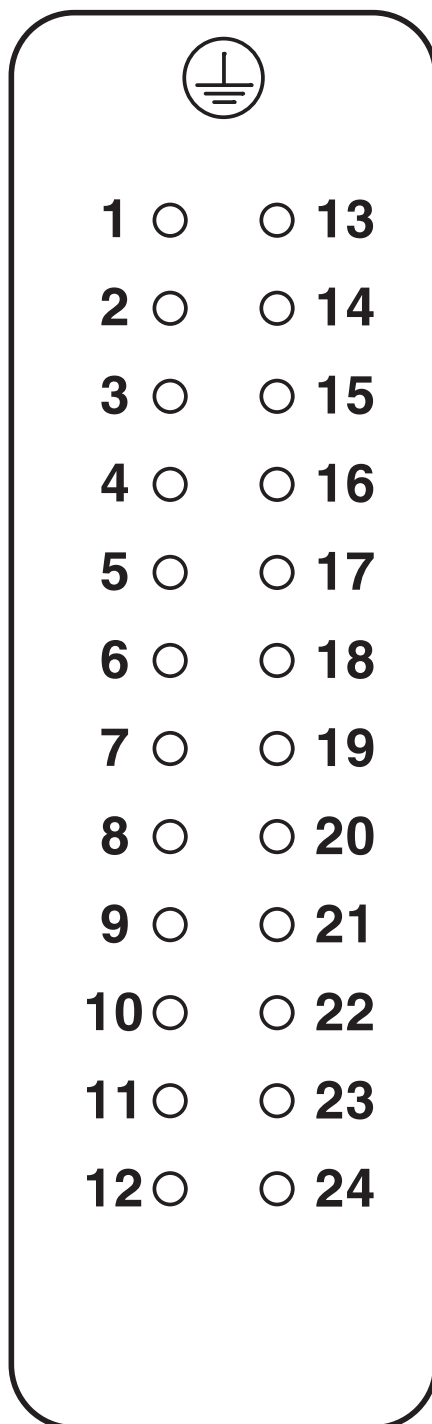

Pin assignment, connection side, socket

HC-STA-B24PT-BWSC-LT-M32-ELCAL - Connector set



1416351

<https://www.phoenixcontact.com/us/products/1416351>

Approvals

🔗 To download certificates, visit the product detail page: <https://www.phoenixcontact.com/us/products/1416351>

DNV

Approval ID: TAE000037S



EAC

Approval ID: RU C-DE.AI30.B.01102



EAC

Approval ID: RU C-DE.BL08.B.00511

HC-STA-B24PT-BWSC-LT-M32-ELCAL - Connector set



1416351

<https://www.phoenixcontact.com/us/products/1416351>

Classifications

ECLASS

ECLASS-11.0	27440101
ECLASS-12.0	27440113
ECLASS-13.0	27440113

ETIM

ETIM 9.0	EC002636
----------	----------

UNSPSC

UNSPSC 21.0	39121400
-------------	----------

HC-STA-B24PT-BWSC-LT-M32-ELCAL - Connector set



1416351

<https://www.phoenixcontact.com/us/products/1416351>

Environmental product compliance

EU RoHS

Fulfills EU RoHS substance requirements	Yes
Exemption	6(c)

China RoHS

Environment friendly use period (EFUP)	EFUP-50
	An article-related China RoHS declaration table can be found in the download area for the respective article under "Manufacturer declaration". For all articles with EFUP-E, no China RoHS declaration table issued and required.

EU REACH SVHC

REACH candidate substance (CAS No.)	Lead(CAS: 7439-92-1)
SCIP	02aa8f96-ec1b-42f0-bc23-beba10c1ef94

Phoenix Contact 2024 © - all rights reserved

<https://www.phoenixcontact.com>

Phoenix Contact USA
586 Fulling Mill Road
Middletown, PA 17057, United States
(+717) 944-1300
info@phoenixcon.com