

3M Purification Inc.

Systems for Resins, Coatings, and Inks



Innovative Filtration Solutions

Quality. Consistency. Performance.





Performance

3M Purification's filtration technology can be used in the continuing drive for lower manufacturing costs. The correct application of specialized filtration technology early in the manufacturing process can reduce total filtration costs significantly. The system-wide approach to filtration will:

- Increase plant output
- Reduce or eliminate recirculation
- Improve product quality
- Decrease overall operating costs

Innovation

3M Purification's long recognized as a leader in high quality coatings filtration, continues to provide innovative solutions to the challenges of resin, paint and ink filtration. Advances in filtration technology are designed to:

- Improve product quality
- Reduce product waste and disposal costs
- Reduce operator exposure to hazardous chemicals
- Reduce operating costs

Quality

Increasing demand for more uniform coatings and resins has compelled suppliers to consistently manufacture and deliver higher quality products to a broad application base. 3M Purification meets the demand with filtration systems that:

- Improve product quality
- Reduce processing time
- Minimize or eliminate product rework



Contents

Page

4 Performance, Innovation, and Quality

5 Applications

- 5 ■ Raw Materials, Intermediates, and Feed Streams
- 7 ■ Resins
- 8 ■ Trade Paint
- 10 ■ High Quality Paint
- 12 ■ Electrodeposition Paints
- 14 ■ Automotive Top Coats
- 16 ■ Inks

18 The Nature of Contaminants

19 Selection of the Proper Filter System

21 Filter Construction

Products

- 22 ■ Betapure™ AU Series
- 24 ■ Betapure™ BK Series
- 25 ■ Zeta Plus™ Filters
- 26 ■ Zeta Plus™ Filter Systems
- 27 ■ Micro-Klean™ RB Series
- 28 ■ Betafine™ XL Series
- 29 ■ 3M™ Activated Carbon Series Filters

29 Filter Housings

- 29 ■ 3M™ ES Series Filter Housings
- 30 ■ 3M™ DC Series Filter Housings
- 31 ■ 3M™ CT Series Filter Housings
- 31 ■ CUNO™ CTG-Klean Filter Systems
- 34 ■ 3M™ 7PC Series Filter Housings
- 35 ■ 3M™ AL Series Filter Housings
- 36 ■ Custom Filter Housing Designs

37 3M Purification Inc. Worldwide Support and Service

Experience

3M Purification Inc., with over 100 years of providing cost effective solutions to industry, designs and manufactures filtration and separation systems to a broad customer base including:

- Health Care - Pharmaceutical, Biotechnology, and Diagnostics
- Industrial - Food & Beverage, Coatings, Chemical, Electronics, and Oil & Gas
- Consumer - Drinking water, Food Service, and Commercial

No matter what your filtration requirement is, 3M Purification has the “know-how” to ensure that the filtration is always right the first time!

Performance, Innovation, and Quality

For many years, 3M Purification filtration systems have been used to ensure that coatings producers efficiently manufacture a superior product.

As coatings producers work towards the goal of reduced operating costs, increased production, and improved product specifications, 3M Purification's advanced filtration technologies provide the solution. From resin haze removal to the filtration of the finest paints and inks, manufacturers know they can look to 3M Purification for answers.

Performance

3M Purification's filtration technology and superior products lead the industry in providing cost effective solutions for challenging filtration applications. Some of 3M Purification's advanced filtration technologies include:

- Absolute Ratings for consistent filtration quality throughout the filter's service life
- Rigid filter structure for enhanced contaminant removal, particle loading, and long service life
- True classifying filters that remove undesired large particles while allowing smaller pigments and desired components to pass
- Depth filtration for enhanced particle loading and extended service life
- Broad range of filter housings that feature ease of use, reduced operator exposure, and are easy to clean

Appropriate application of these technologies result in total filtration savings of up to 50%, and include the following process benefits:

- A dramatic reduction or elimination of product recirculation for improving productivity and lower processing costs
- Increased service life of final filters
- Reduced filter change-out frequency, product loss, disposal costs, labor, and filter inventory
- Eliminated or reduced system cleaning

Innovation

3M Purification continues to develop innovative product in direct response to industry requirements. Filtration specialists, dedicated to the coatings and resin markets, working closely with customers, continue to improve 3M Purification's filtration solutions by providing:

- Products that further reduce overall filtration costs
- Systems that reduce operator exposure to hazardous materials
- Excellent technical service and field support

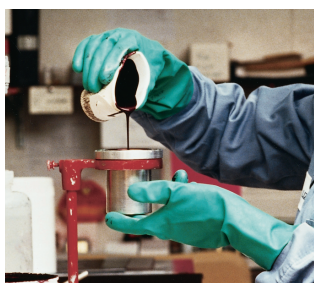

Figure 3 - Quality isn't something you inspect into the final product, it's something you manufacture into each process step.



Figure 1 - Betapure™ AU Series filter cartridge is the finest classification cartridge available providing the manufacturer of pigmented product superior performance.



Figure 2 - CUNO™ CTG-Klean filter system brings a new level of safety and usability to the coatings and inks manufacturer. No longer does the partially-used filter cartridge have to be disposed of. Simply secure the pack inlet/outlet caps, remove the filter pack and store until you need it! In addition, the totally enclosed filter pack addresses the hazardous material and operator exposure issues—primary concerns of the paint and coatings industry.

Quality

In the coatings industry, quality is obtained by meeting or exceeding product specifications and target operating costs. 3M Purification product is often called upon to:

- Increase process efficiency
- Reduce product rework
- Eliminate product down-grading
- Minimize scrap

3M Purification's system approach of applying the proper filter at manufacturing points where contaminants enter the process results in higher yields while lowering operating costs. This system approach to contaminant removal combined with a broad offering of superior products ideally suited for coatings manufacturing, provides the ultimate process benefit:

Coatings filtered to specification the first time—every time!

Figure 4 - 3M™ ES Series Filter Housings (left) provide the assurance of an ASME Code vessel, the flexibility of a custom designed unit, and the delivery of a standard product! The 3M ES series filter housing—what you need, when you need it!



Raw Materials, Intermediates, and Feed Streams

The resin, paint or ink final product quality—conformance to specification – ultimately depends on the incoming raw materials, intermediates, or feed streams. Contaminants introduced at these points have a significant impact on the product quality and manufacturing costs. Figure 5 below depicts the introduction of the intermediate/feed streams to the dispersion tank or reactor. Proper filtration at these key points with the products listed in Table 1 will eliminate contaminants before they become a problem.

Filtering too little, too late

Filtration of paints and inks only as a final production step makes it difficult to ensure quality and impossible to control costs.

Applying filtration only at the end of the production cycle requires:

- Clarification of contaminants introduced by the intermediates
- Classification of the pigmented paint
- Removal of solid contaminant, salts, haze, fibers, and semi-solids

To “filter in” the product quality, with a final filter only, is too much to ask of any one filter. The typical process of continuously recirculating product through the filter is costly, time consuming, and often does not provide the level of product uniformity demanded by today’s product specifications.

Contaminant removal before it becomes a problem can reduce total filtration costs by up to 50% or even more!

Figure 5

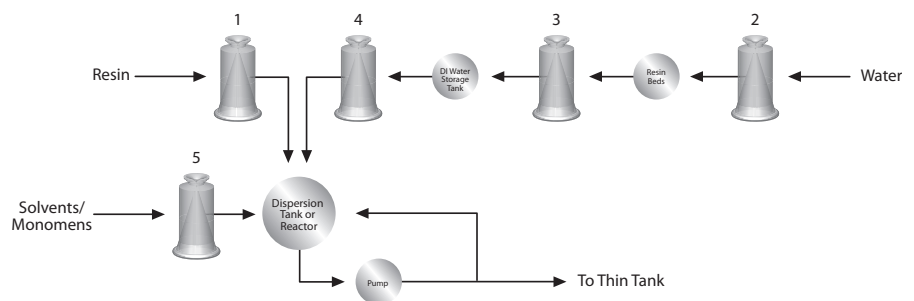



Figure 6 - Before adding a resin to your coating, use Betapure™ AU series filters and supply only the cleanest resin to your process!



Figure 7 - 3M Purification's unique design provides all the activated carbon advantages in a clean, easy-to-use, cartridge!



Figure 8 - Betafine™ XL series filter is a long lasting and economical pre-filter for resin trap, DI water and solvent applications.

The Solution

Applying filtration as a key element throughout the entire manufacturing cycle is critical in maintaining process control and meeting the next level of quality specifications. Removing contaminants at their point of origin—before introduction to the dispersion tank, mix tank, or reactor—will reduce overall filtration costs and significantly impact the process by:

- Increasing productivity
- Improving product consistency
- Drastically reducing rework and scrap
- Reducing disposal costs

Application Recommendations

Resin, the vehicle for coatings, has a significant impact on paint and ink quality. The filtration of resin to remove agglomerates and contamination from shipping containers is essential. Betapure™ AU and Betapure™ BK series, absolute rated, rigid, depth filters, will remove semisolids that cause craters as well as salts and solid contaminants that are commonly found in resins.

Water, used for the production of DI water must be filtered to eliminate chlorine and contaminant that could shorten the useful life of the resin bed. The 3M Purification Activated Carbon Cartridge removes chlorine and trihalomethane (THM) that shorten the life of the DI bed.

Resin trap is a filter that is used to remove any ion exchange beads that may be released from the DI resin bed and maintain the cleanliness of the storage tank. The pleated media Betafine™ XL series absolute rated filter provides long service life and ensures removal of contaminants before they enter the storage tank.

DI water filter is used to eliminate any process or tank contaminant before the DI water is introduced into the dispersion or mix tank. The Betafine XL series pleated structure provides long service life and will assure the highest possible water quality at a low operating cost.

Solvents and monomers are key ingredients used in the production of paints, inks and resins. These products typically have low levels of contaminants making Betafine XL series an ideal dedicated filter. The pleated polypropylene media provides long service life and a broad range of compatibility, and clarifies the fluid before it is introduced into the process.

Table 1 - Application Guide for Raw Materials, Intermediates, and Feed Streams

Application	Figure 5 Location	3M Purification Filter Cartridge	See Page	Suggested Absolute Rating	Recommended Flow per 10" Filter GPM (LPM)	Recommended Housing	See Page
Resin	1	Betapure™ AU Series Betapure™ BK Series	22 24	30-70 30-70	3-5 (11-19) 3-5 (11-19)	3M™ ES Series 3M™ ES Series	29 29
Water	2	3M™ Activated Carbon Cartridge	29	--	1-2 (4-8)	3M™ DC Series	30
Resin Trap	3	Betafine™ XL Series	28	5	5-8 (19-30)	3M™ DC Series	30
DI Water	4	Betafine™ XL Series	28	5	5-8 (19-30)	3M™ DC Series	30
Solvent/ Monomer	5	Betafine™ XL Series	28	1	5-8 (19-30)	3M™ CT Series	31



Resins

Thermoset resins, such as alkyds, acrylics, epoxies, and polyesters are key components in the production of a broad range of coatings—from trade paints to high transparency automotive top coats. As a result, improved resin consistency leads to improved final product. For years, resin manufacturing has provided process challenges. New technologies that utilize resins in their formulation such as high solids and water borne coatings, powder coatings, and ultraviolet cured coatings are evolving in efforts to reduce harmful emissions and reduce energy costs. Regardless of the resin type or composition, meeting the product specification remains the goal.

Figure 9 - Resin clarity specifications are often based on visual, Gardner, or APHA techniques. Regardless of the inspection method, 3M Purification has the solution. Shown above is single pass resin haze removal by Zeta Plus™ filters (before left, after right).

The System

Contaminants that compromise meeting resin specification have many forms—hard particles, salts, non-rigid gels, fibers, or haze— and must be removed. 3M Purification filtration technology addresses the removal of each of these contaminants in a cost effective manner as shown in the schematic below and listed Table 2.

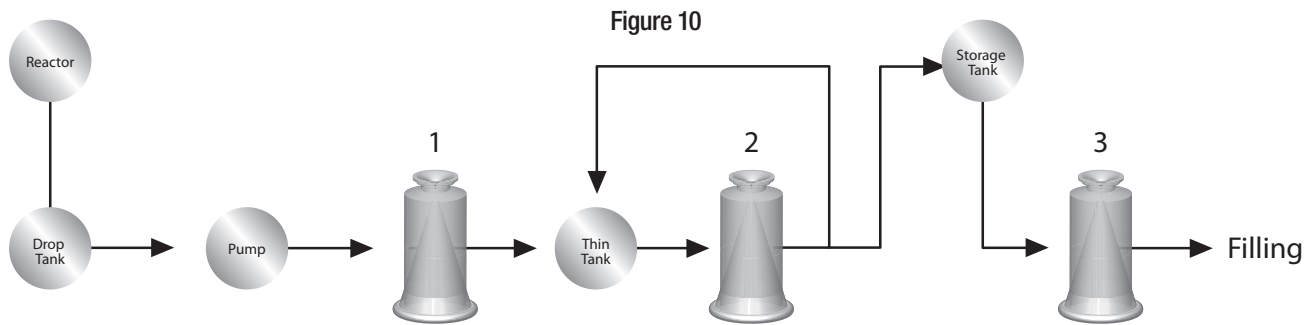

The Problem

Resin production presents many challenges since the process is often at elevated temperatures and the process reaction generates unpredictable contaminant size, type and quantity. These contaminants and haze (see page 21) in the resin result in cratering, fish eyes, dull finishes, and particulate defects in the end user product. To avoid this, the resin must be reworked, regraded, or even scrapped. Filtration practices, such as continuous recirculation through filter cartridges or presses, is not a cost-effective means of contaminant removal and results in:

- Bypass and poor resin quality with redundant quality checks
- Filter change-out within a batch
- Increased production time, labor, and worker exposure to VOC's
- Increased disposal costs and resin scrap

The Solution

Because of the variation of contaminant type and size, it is often impossible to cost-effectively use one filter type for acceptable removal. The primary 3M Purification recommendation is to use Betapure™ BK series for removal of rigid and deformable particulate, as well as fibers, and Zeta Plus™ for haze removal.

Betapure BK series filters are ideal for the removal of salts, fibers, solids and semi-solids. The absolute-rated, rigid structure will not unload contaminant as the differential pressure increases – effluent quality is maintained through the filter's service life! In addition, the Betapure BK series filter's depth ensures removal of semi-solids while the graded-porosity structure and grooved surface provide exceptional service life and value. For applications that require more open (greater than 70 micron) filtration, the time-proven Micro-Klean RB series filter is recommended.

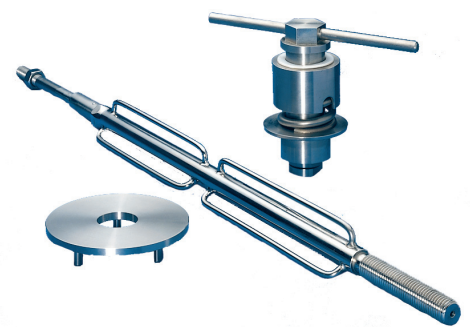

Figure 11 - The Sparkler®* press retrofit kit, lets you gain the benefits of Zeta Plus™ Series filtration without a major capital equipment investment.

Converting from a Sparkler Press to Zeta Plus™ Series Cartridge System has Reduced Resin Recirculation by up to 90%!

Zeta Plus™ series filter cartridges are recommended for removal of haze from resins. Haze is typically the result of very fine particulate present in the resin and is not easily removed through sieving techniques alone. The Zeta Plus series charge-modified media enhances the sieving technique by removing fine particles through electrokinetic adsorption, allowing for a more open media structure for improved flow characteristics. To obtain the benefits of Zeta Plus series haze removal with existing hardware, the media is available in both sheets and cartridges (see page 27).

The 3M™ ES series filter housing is ideal for resin filtration and is available for either Betapure BK series and Zeta Plus series style cartridges (see page 26). The user-friendly housing design provides leak-free operation and permits rapid cartridge change-out.

3M Purification's resin filtration experience has assisted our customer's achievement of substantial cost savings and has helped establish new quality standards. Typical benefits experienced are:

- Elimination of system leaking for reduced VOC's and increased operator safety
- Single pass resin filtration meets product specification without the use of external filter aids
- Elimination of filter change-out during batch filtration
- Reduced product loss up to 90% and disposal costs up to 83%
- Reduced labor cost up to 88%



Figure 12 - Zeta Plus™ filter cartridges are available in a wide variety of styles and sizes to accommodate a broad range of resin processing systems.

Table 2 - Application Guide for Resins

3M Purification Filter Cartridge	Figure 10 Location	See Page	Recommended Flow Rate per 10" Filter	Suggested Filter Rating	Recommended Housing	See Page
Betapure™BK Series Micro-Klean™ RB Series	1	24 27	3 GPM (11 LPM) 3 GPM (11 LPM)	5-70 µm Abs 75-150 µm Nom	3M™ ES Series 3M™ ES Series	29 29
Betapure™ BK Series Micro-Klean™ RB Series Zeta Plus™	2	24 27 25	3 GPM (11 LPM) 3 GPM (11 LPM) 1/2 GPM/FT² (2 LPM/FT²)	5-70 µm Abs 75-150 µm Nom 05U, 01A, 05A, 10A, 20A, 30A	3M™ ES Series 3M™ ES Series 3M™ PT1B	29 29 35
Betapure™ AU Series	3	22	3 GPM (11 LPM)	2-160 µm Abs	3M™ ES Series	29
Betapure™ BK Series Micro-Klean™ RB Series Betapure™ AU Series	3	24 27 22	3 GPM (11 LPM) 3 GPM (11 LPM) 3 GPM (11 LPM)	5-70 µm Abs 75-150 µm Nom 2-160 µm Abs	3M™ ES Series 3M™ ES Series 3M™ ES Series	29 29 29

* Sparkler is the registered trademark of Sparkler Manufacturing Company, Conroe, TX.



Trade Paint

Trade paints are used in a wide variety of applications from house paints to prepackaged spray enamels. Trade paints are typically defined as coatings that are applied “on-site” in ambient conditions. The paints have a wide variety of quality specifications.

The System

The manufacturing schematic, shown in Figure 13, outlines the general process and shows a number of raw materials mixed together through a milling and then a thinning step to produce the paint. Key filtration points and products are identified in Table 4.

Figure 13 - Refer to Intermediates for Resins, Paints and Inks, Page 5

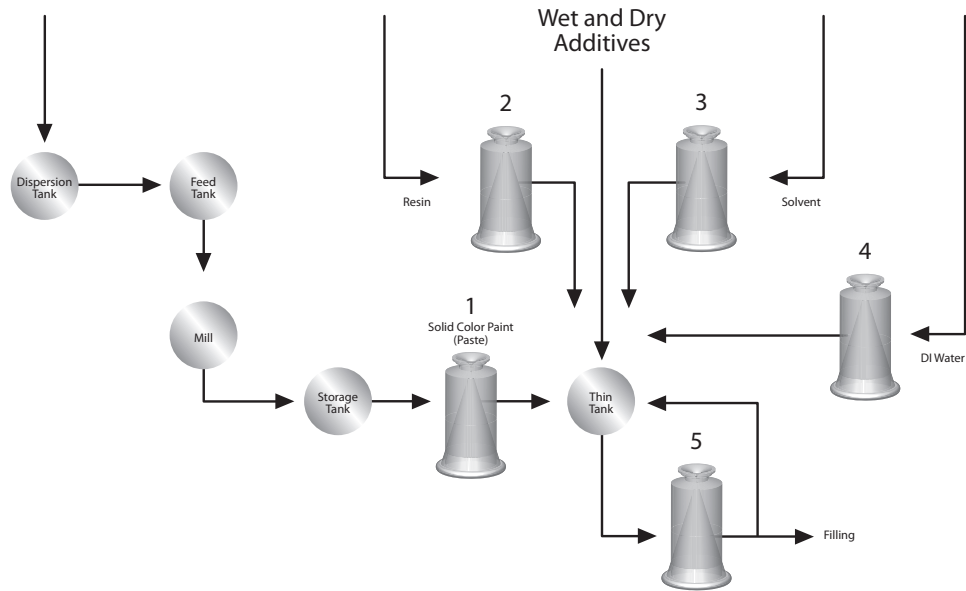

The Problem

Manufacturing of trade paints is typically a batch process where the paint is often recirculated through a filter until the product quality specification is met. Manufacturers often experience:

- Poor equipment utilization because of unnecessary and frequent paint recirculation
- Operator exposure to volatile organic compounds (VOC's)
- Unacceptable product quality
- Excessive filter costs because of short filter life, high disposal costs, and excess inventory

The Solution

3M Purification recommends the filtration of incoming raw materials and intermediates to eliminate the majority of the product contaminant (see page 6) at their source and the use of the Micro-Klean™ RB series cartridge for the final filter. The Micro-Klean RB series rigid resin bonded construction maintains the pore size and particle removal efficiency throughout its entire service life, providing consistent and repeatable products. Table 3 highlights the advantages of Micro-Klean RB series filters over the commonly used bag or surface filters. The well defined Micro-Klean RB series grade structure offers a complete selection of removal ratings to meet individual application needs and can eliminate product recirculation as a method to achieve the product specification. As a result, Micro-Klean RB series filters can:

- Increase productivity - dramatically reduce processing time and increase equipment utilization by eliminating product recirculation and ensuring product quality the first time!
- Reduce costs - reduce overall cost of filtration due to high filter usage, disposal costs, excess inventory and filter change-outs.



Figure 14 - Micro-Klean™ RB Series filter's rigid depth structure makes it ideally suited for the removal of deformable contaminants including gels.

Table 3

Micro-Klean™ RB Series [Rigid Depth]	Bags [Surface]
Free of media migration; will remove fibers	Passes and may release fibers
Rigid depth filter removes deformables that cause voids in paint	Passes deformables that result in paint defects
Excellent depth classification, eliminates surface plugging and passes desired pigments	Poor classification, media blinds and strips pigments

Table 4 - Application Guide for Trade Paint Filtration

Filter Application	Figure 13 Location	3M Purification Filter Cartridge	See Page	Recommended Flow Rate per 10" Filter	Suggested Absolute Filter Rating	Recommended Housing	See Page
Solid Paint	1	Betapure™ AU Series	22	3-5 GPM (11-19 LPM)	3-50 µm	CUNO™ CTG-Klean	31
Resins	2	Betapure™ AU Series Zeta Plus™	22 25	3-5 GPM (11-19 LPM) 1/2 GPM/FT ² (2 LPM/FT ²)	20-30 µm --	3M™ ES Series 3M™ ES Series	29 29
Solvents	3	Betafine™ XL Series	28	5-8 GPM (19-30 LPM)	1 µm	3M™ CT Series	31
DI Water	4	Betafine™ XL Series	28	5-8 GPM (19-30 LPM)	5 µm	3M™ DC Series	30
Filling	5	Betapure™ AU Series Micro-Klean™ RB Series	22 27	3-5 GPM (11-19 LPM)	3-75 µm 3-125 µm	CUNO™ CTG-Klean	31



High Quality Paint

Coatings of this type are typically used for appliances, office furniture, can coatings, marine and automotive finishes. These paints are classified as high quality and are applied in a controlled environment such as a spray booth.

The System

The need to provide finer, defect-free finishes, while increasing throughput and lowering production costs, continues to plague the high quality coatings industry. The schematic below provides a system approach for filtration of these coatings, allowing manufacturers to meet these increasing demands.

Figure 15 - Refer to Intermediates for Resins, Paints and Inks, Page 5

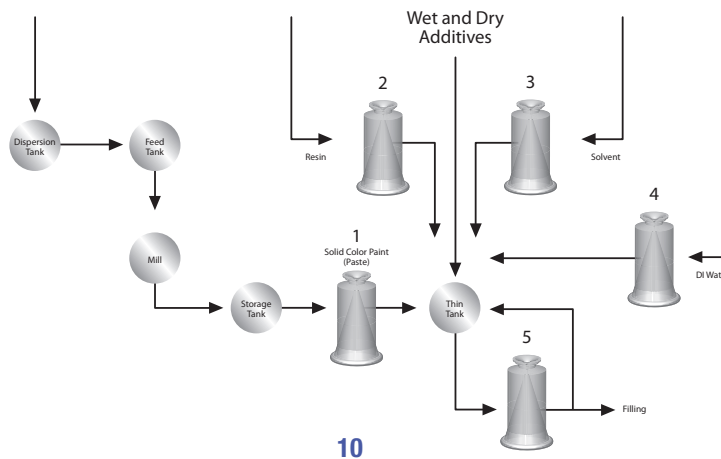

The Problem

The newer and ever increasing paint application technologies allow the end user to apply thinner and thinner coatings. These thin coatings (sometimes as thin as 0.7 mil) place demands on the paint manufacturer to raise the quality specification on the coating. The elimination of foreign particles, gels, and fibers continues to be one of the major issues in paint production. These contaminants are introduced throughout the manufacturing process because of contaminated raw materials and the incomplete mixing of pigments. If not properly removed, these contaminants can result in:

- Cratering problems for the end user
- Rework of product resulting in paint stripped of desired components
- High production costs because of product rework, low productivity, and high material usage
- High filtration costs because of short filter life, high change-out frequency, increased disposal costs and excess inventory levels



Figure 16 - Betapure™ AU Series Cartridges are the ultimate classifying filter and are available in a wide range of particulate removal ratings to meet all application requirements.



Figure 17 - CUNO™ CTG-Klean System Filter System: The filter pack provides the barrier between the paint and the housing, reducing change-out times and operator exposure.

The Solution

3M Purification recommends a filtration systems approach to meet product specification and reduce operating costs. The proper use of filtration for raw materials and intermediates is critical and is described on pages 6 and 7. Product recommendations for solvents, resins and water are found in Table 5 below. For solid paint and filling positions, Betapure™ AU series, the ultimate classifying filter, is recommended. Betapure filters are proven to:

- Classify the paint
- Retain contaminants throughout the filter's life
- Provide long service life

Manufacturers using Betapure AU series filters who have converted from bags, melt-blown, and other types of filters have seen:

- A 50% reduction in scrap
- Increased finished quality
- 3 times the filter service life
- Reduction of waste and disposal
- Reduction of overall filtration costs up to 50%

The CUNO™ CTG-Klean system is a totally enclosed filter pack. No longer is it necessary to dispose of partially used filter cartridges. Simply cap the inlet/outlet ports of the pack and store it until future need for filtration of the product occurs. The enclosed system eliminates the need for housing cleaning and dramatically reduces operator exposure to hazardous chemicals. CUNO CTG-Klean system benefits are:

- Reduced filter costs through reusable packs
- Eliminates the need to clean the housing
- Reduces operator exposure to hazardous chemicals
- Reduces conversion time to new products/colors by up to 80%

Table 5 - Application Guide for High Quality Paint Filtration

Filter Application	Figure 15 Location	3M Purification Filter Cartridge	See Page	Recommended Flow Rate per 10" Filter	Suggested Absolute Filter Rating	Recommended Housing	See Page
Solid Paint	1	Betapure™ AU Series	22	3-5 GPM (11-19 LPM)	3-50 µm	CUNO™ CTG-Klean	31
Resins	2	Betapure™ AU Series Zeta Plus™	22 25	3-5 GPM (11-19 LPM) 1/2 GPM/FT ² (2 LPM/FT ²)	20-75 µm --	3M™ ES Series 3M™ ES Series	29 29
Solvents	3	Betafine™ XL Series	28	5-8 GPM (19-30 LPM)	1 µm	3M™ CT Series	31
DI Water	4	Betafine™ XL Series	28	5-8 GPM (19-30 LPM)	5 µm	3M™ DC Series	30
Filling	5	Betapure™ AU Series	22	3-5 GPM (11-19 LPM)	3-75 µm	CUNO™ CTG-Klean	31

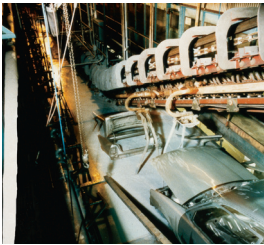

Electrodeposition Paints

The assurance of quality and durability of high performance finishes, begins with a rust inhibitor foundation of water-based electrodeposition (ED) paint. Contaminant-free ED paint is critical, placing stringent requirements on the paint manufacturer.

The System

The schematic below outlines a typical ED paint production sequence and pinpoints where raw materials, intermediates, and final products should be filtered. See product recommendations in Table 6.

Figure 18 - Refer to Intermediates for Resins, Paints and Inks, Page 5

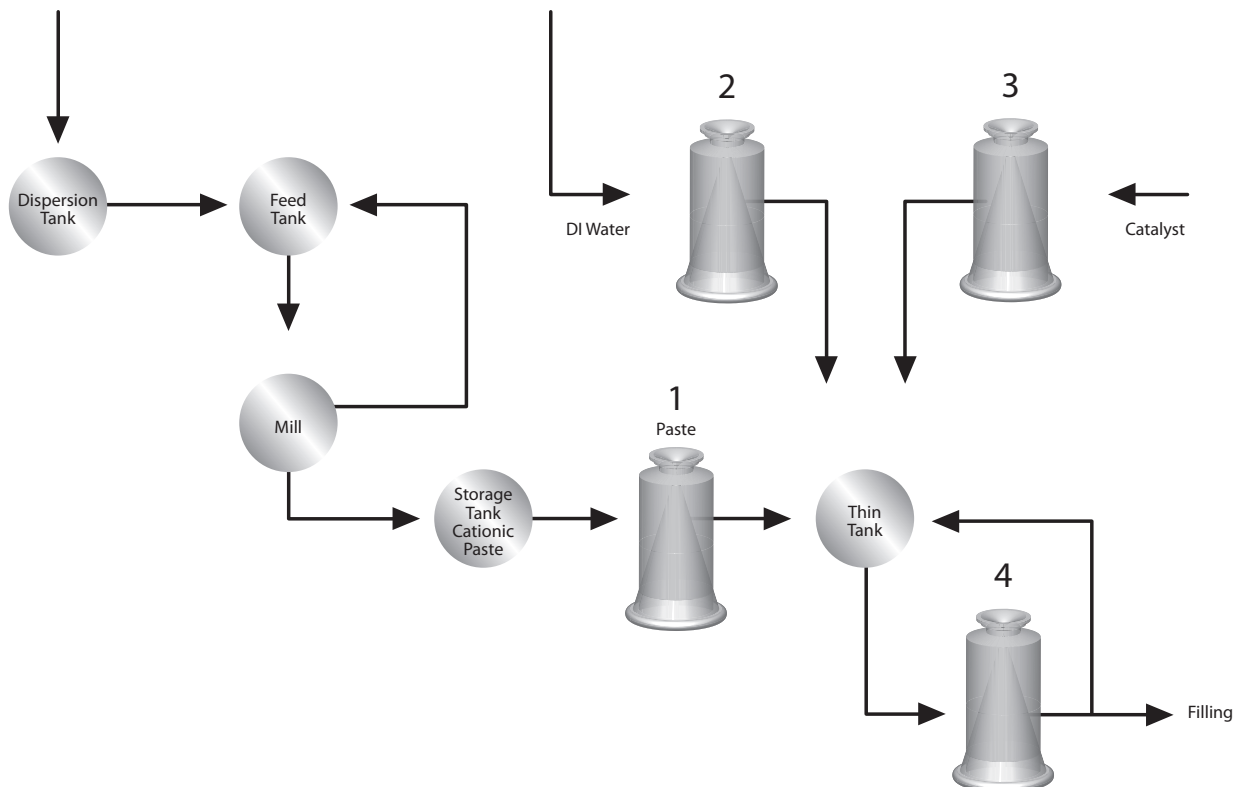

The Problem

ED paint applications are sensitive to contaminants that result in cratering and rework of expensive finishes. These contaminants are often introduced in the ED paint manufacturing process through:

- Water and Intermediates - Solid particles
- Paste - Large agglomerated pigments, solid contaminants from raw materials, and poor dispersion of ingredients
- Resins - Shear sensitive gels and solid particles
- Catalyst - Agglomerated fine particles

To meet end user specifications, manufacturers typically incur unnecessarily high production costs because of:

- Rejected product
- Repeated quality checks
- Unnecessary recirculation of product
- High costs of filtration



Figure 19 - Betapure™ AU Series Filter Cartridges are ideally suited for the filtration of pastes and the final filling operation.



Figure 20 - Betafine™ XL Series Filter Cartridge are pleated filters that provide consistent performance and long life.

The Solution

To process electrodeposition paints most effectively, 3M Purification recommends filtration of ingredients and intermediates to remove contaminants before processing (see pages 6 and 7). The contaminants present in feed streams can be easily removed prior to the dispersion tank. The result is simple—a lower overall filtration cost.

The filter cartridge used in the ED process (Figure 18) must efficiently remove large or agglomerated pigments and solid contaminants. To ensure proper classification of pigments and other components, 3M Purification recommends the following filter cartridges for:

- Paste - The classifying capability and absolute rating of Betapure™ AU series cartridge removes large particles while allowing vital pigments to pass through.
- Catalyst - The absolute rated Betafine™ XL series will remove contaminant from the catalyst prior to introduction into the paint. The contaminants are agglomerated fine particles, residue from shipping or contaminant from the process lines.
- Filling - Betapure™ AU series, the ultimate absolute rated classifying filter, selectively removes the large contaminants from the paint. The rigid Betapure™ AU series structure consistently provides high quality ED paint under varying process conditions.

The system approach of properly filtering raw materials, intermediates and final product will often increase manufacturer profitability by:

- Increasing equipment utilization—reducing recirculation by up to 50%
- Reducing quality checks for paint approval
- Eliminating the problem of rejected paint
- Decreasing overall filtration costs Reduction of overall filtration costs up to 50%

The 3M™ ES series filter housing is recommended for filtration prior to filling. The housings are available in a variety of sizes to meet individual application flow requirements. The 3M ES series filter housing offers:

- Easy access for filter change-out and housing cleaning
- ASME Code where required
- Design flexibility to meet most installation requirements

Table 6 - Application Guide for Electrodeposition

Filter Application	Figure 18 Location	3M Purification Filter Cartridge	See Page	Recommended Flow Rate per 10" Filter	Suggested Absolute Filter Rating	Recommended Housing	See Page
Paste	1	Betapure™ AU Series	22	3-5 GPM (11-19 LPM)	30-100 µm	3M™ ES Series	29
DI Water	2	Betapure™ AU Series	22	5-8 GPM (19-30 LPM)	5 µm	3M™ DC Series	30
Catalyst	3	Betafine™ XL Series	28	3-5 GPM (11-19 LPM)	10 µm	3M™ DC Series	30
Filling	4	Betapure™ AU Series	22	3-5 GPM (11-19 LPM)	40-70 µm	3M™ ES Series	29
		Betapure™ BK Series	24	3-5 GPM (11-19 LPM)	40-70 µm	3M™ ES Series	29



Automotive Top Coats

Solvent and water-borne paints are manufactured for spray application to automotive bodies as primers, base coats and clear coats. Preparing a paint recipe is a complex process with a number of operations and ingredients—solids of various particle sizes and characteristics, resins, solvents and/or water.

The System

The schematic below depicts a conventional automotive top coat manufacturing system. Since each additive is unique, no single filter can effectively be used. Table 7, Application Guide to Top Coat Filtration, recommends the proper and most cost effective filter and housing for each ingredient.

Figure 21 - Refer to Intermediates for Resins, Paints and Inks, Page 5

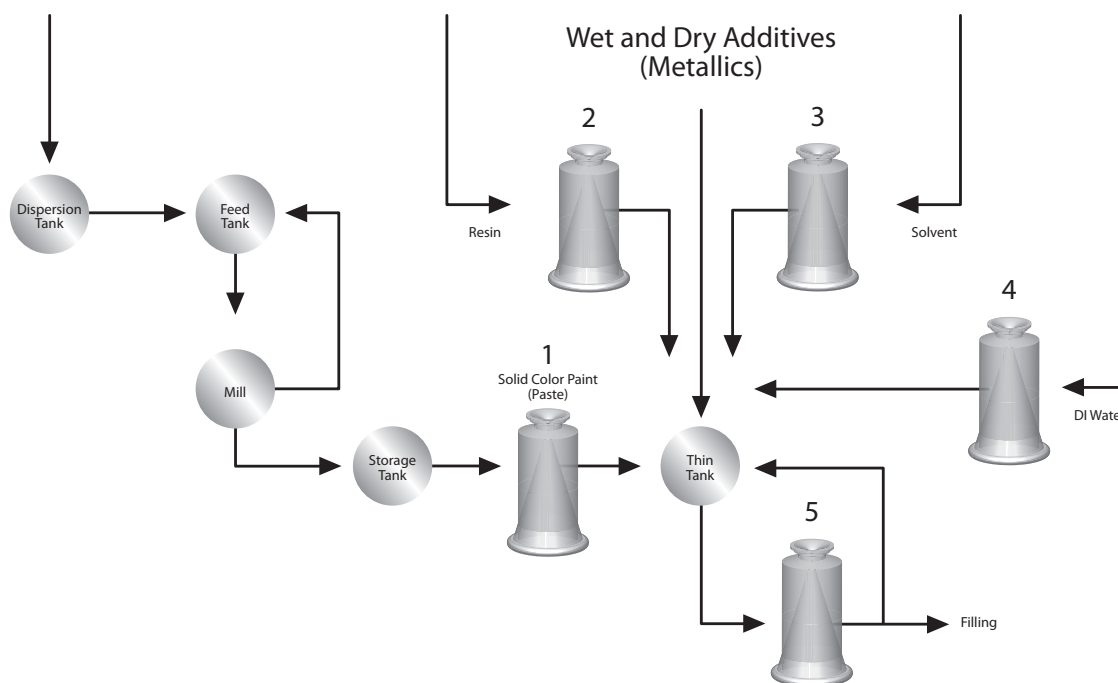

The Problem

Critical to meeting or exceeding the paint quality standards is the ability to pass spray panel or screen testing by eliminating contaminants such as fibers, semi-solids, and solids from automotive paint. Historically, this burden has been placed on the final filter just prior to filling and continuous recirculation is often required resulting in:

- Stripping of pigments and metallics
- Reduced filter life
- Increased labor
- Increased disposal cost
- Lengthy processing time



Figure 22 - Betapure™ AU Series cartridges, premium classifying filters, remove fibers and deformables that cause craters and fish eyes.



Figure 23 - CUNO™ CTG-Klean System: The filter pack provides the barrier between the paint and the housing, reducing change-out times and operator exposure.

The Solution

The filtration of intermediates is the best way to control the manufacturing process and to ensure the quality of the final product. Employing this practice will eliminate the contaminants that are difficult if not impossible to remove later in the process.

Classifying filtration of the automotive paint is a must for pastes (filter position 1 in Figure 21) supplied to the thinning tank and the final filter prior to filling (filter position 5 in Figure 21). Historically, this location has had the burden of filtering in quality. With the introduction of intermediate filtration this burden is greatly diminished. However, the final filter remains the critical element in the production of automotive paint.

Betapure™ AU series filter cartridge improves quality and reduces rework to lower overall manufacturing cost. The absolute-rated classifying (see page 23) Betapure AU series filter removes large, undesirable, particles that have agglomerated or that were not removed by intermediate filtration. The depth structure will also enhance the removal of deformables that cause craters and fish eyes.

The CUNO™ CTG-Klean system, a totally enclosed filter pack, is a system that allows the reuse of filters that haven't been used to capacity. Complete use of a filter's capacity can reduce filtration costs by up to 50%. In addition, this system eliminates the need for housing cleaning, reduces solvent usage, and eliminates the housing as another source of contaminant while addressing ever growing environmental concerns, limiting operator exposure, and reducing disposal costs.

Filtering of intermediates used in conjunction with 3M Purification filters and using the CUNO CTG-Klean system in the filling process will result in the following benefits:

- Reduce recirculation time by 50%, labor by 10% and overall filtration costs by 25% to 50% or more!
- Reduce quality checks for paint approval by 50%
- Increase capacity through improved equipment utilization reduced rejected paint
- Reduce/eliminate the need to clean housings and improve paint quality
- Reusable filter packs increase filter life by 5 times

Table 7 - Application Guide for Automotive Top Coat Filtration

Filter Application	Figure 21 Location	3M Purification Filter Cartridge	See Page	Recommended Flow Rate per 10" Filter	Suggested Absolute Filter Rating	Recommended Housing	See Page
Solid Paint	1	Betapure™ AU Series	22	3-5 GPM (11-19 LPM)	3-50 µm	CUNO™ CTG-Klean	31
Resins	2	Betapure™ AU Series Zeta Plus™	22 25	3-5 GPM (11-19 LPM) 1/2 GPM/FT ² (2 LPM/FT ²)	20-30 µm --	3M™ ES Series 3M™ ES Series	29 29
Solvents	3	Betafine XL Series	28	5-8 GPM (19-30 LPM)	1 µm	3M™ CT Series	31
DI Water	4	Betafine XL Series	28	5-8 GPM (19-30 LPM)	5 µm	3M™ DC Series	30
Filling	5	Betapure™ AU Series	22	3-5 GPM (11-19 LPM)	20-160 µm	CUNO™ CTG-Klean 7 PC	31 34

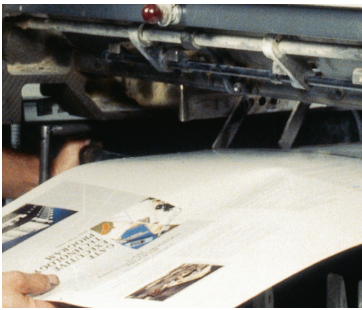

Inks

Whether the ink is heat off-set, lithographic, flexographic, or gravure, achieving the product specification is a challenge. Conforming to the two requirements—ink color and pigment grind—can be a time consuming operation. This is of particular importance in specialty inks where color matching is required. Aside from the ink type or composition, conformance to product specification remains the goal.

The System

Ink could be contaminated by many sources during production. These can be of various types—fibers, solids, and semi-solids, complicating production to an even greater degree. Often, system recirculation is required to completely eliminate a contaminant. The system filter has the burden of maintaining pigment concentration and color while removing contaminants and ensuring that grind standards are met. Figure 24 identifies the key filtration location with the appropriate filtration system recommendation in Table 8.

Figure 24 - Refer to Intermediates for Resins, Paints and Inks, Page 5

Raw Materials

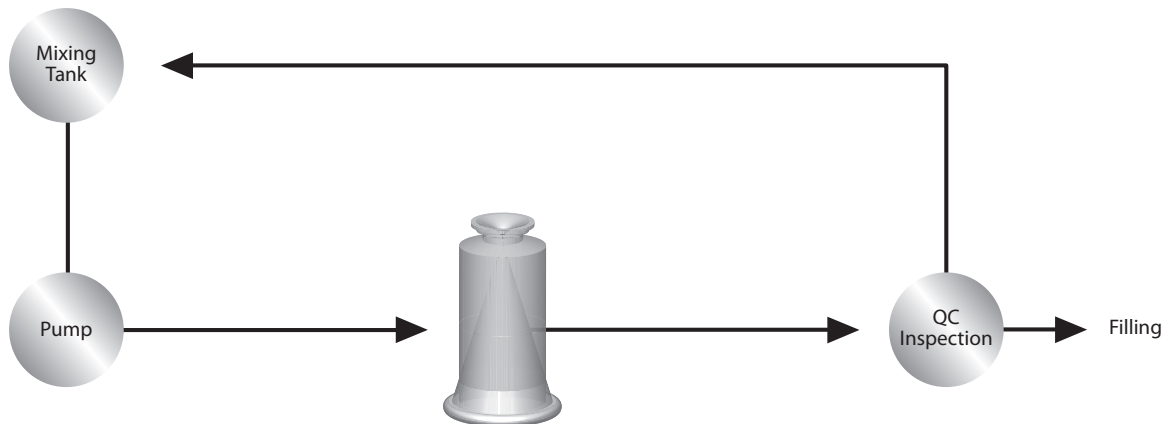

The Problem

Typical ink manufacturing processes require continuous recirculation and multiple quality checks to attain the product color and grind specifications. Many times the filter being used plugs before the batch is complete, requiring filter change-out and additional quality checks. In addition, the batch filtration process dictates filter disposal at the end of a color specific batch, even if the cartridge life isn't used. When process equipment is used for more than one color ink, the system must be thoroughly cleaned, filters changed, and used filters properly disposed. These system practices result in:

- Productivity reduced by recirculation and repeated quality checks
- Manufacturing capacity reduced by poor equipment utilization
- Increased filter use and disposal costs
- Increased labor costs
Increased disposal cost
- Lengthy processing time



Figure 25 - The Betapure™ BK Series filter's absolute-rated rigid depth structure make it ideally suited for the removal of deformable as well as rigid contaminants from the ink production process.

The Solution

Pretreatment by filtration of ink components prior to mixing (see page 6) reduces the level of contaminants in the mixing tank and allows the system filter to meet the color and grind specifications. 3M Purification recommends the Betapure™ BK series cartridge for the filtration of ink. The absolute rated rigid resin bonded filter cartridge maintains the designed pore structure through the entire service life to provide consistent and repeatable results and up to double the filter life.

- Absolute ratings ensure that contaminants are removed
- A well defined grade structure offering a complete selection of removal ratings to meet the individual application needs eliminating recirculation and dependence on a variable "filter cake"
- Graded porosity depth structure also enhances the filter's service life by removing the large contaminants near the outside of the filter and progressively smaller contaminants as they progress through the filter

Betapure™ BK series filters used with the CUNO™ CTG-Klean system filter system provide an ideal solution for ink filtration. Using a CUNO CTG-Klean filter pack isolates the ink and filters from the housing to eliminate cleaning. An additional benefit is that partially used filter cartridge packs can be stored and reused on subsequent batches of the same product. Simply remove the pack, cap it, store it, and reinstall it at a later date.

A Betapure BK series and CUNO CTG-Klean system addresses the entire process.

- Betapure BK series filters reduce or eliminate recirculation to increase productivity by allowing greater equipment utilization
- Filter pack design eliminates housing cleaning between color changes and reduces filter disposal costs by allowing reuse



Figure 26 - CUNO™ CTG-Klean System: The filter pack provides the barrier between the ink and the housing, reducing change-out times and operator exposure.

Table 8 - Application Guide for Ink

3M Purification Filter Cartridge	See Page	Recommended Flow Rate per 10" Filter	Suggested Absolute Filter Rating	Recommended Housing	See Page
Betapure™ BK Series	24	3 GPM	5-70 mm	CUNO™ CTG-Klean 3M™ ES, DC, and AL Series	29-35

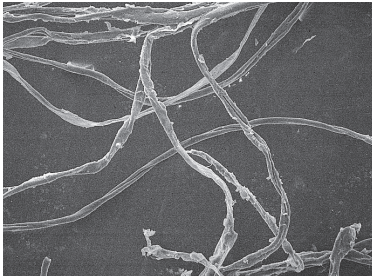

Figure 27 - SEM Photomicrograph of Cellulose Fibers.

The Nature of Contaminants

Contaminants in resin, paint and ink are introduced at various points in the manufacturing process. Sources include raw ingredients, holding tanks, shipping containers, system piping, mills, airborne contaminants from employee clothing, cleaning rags, and general cleaning processes. To further complicate the process, contaminants come in many forms such as fibers, salts, solid particles, semi-solids and gels.

Fibers

Contaminant fibers cause resin, paint and ink defects. 3M Purification's coating laboratory uses sophisticated Scanning Electron Microscopy (SEM) and Fourier Transform Infrared Spectroscopy (FTIR) to characterize fibers and discover their origins. When the source of a contaminant fiber is found, corrective action can be taken.

Flat and ribbon shaped fibers are natural fibers that originate from rags, clothing, bags, and paper products. Identification of the fiber (Figure 27) using the SEM depicts this characteristic. The identification is reinforced by the FTIR (Figure 28) "fingerprint" of the fiber. Comparison of the fiber's spectrum to the extensive library of fiber spectra in 3M Purification's laboratory positively identifies the contaminant fiber as cellulose.

Since natural and synthetic fibers both cause defects, the filters must always eliminate fibers and never contribute fibers to the product. The Betapure™AU series, Betapure™ BK series and Micro-Klean™ RB series filter cartridges meet these exacting requirements.

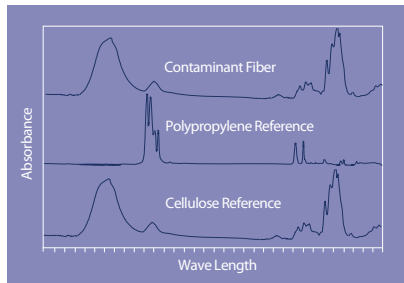

Figure 28 - Fourier Transform Infrared Spectroscopy (FTIR) Fingerprint Identifies Contaminant Fiber as Cellulose

Salts & Solid Contaminants

Contaminants that fall into this category are easily removed through sieving. This is accomplished by utilizing a filter structure with pores smaller than the contaminant. However, selection of the appropriate filter media can dramatically impact the overall filtration cost. 3M Purification simplifies the decision making process by providing years of experience along with products designed specifically for coating applications.

Semi-Solid Contaminants

The most difficult contaminants to remove are deformable or soft agglomerates of oils, gels, or silicones. These contaminants displace paints and inks upon application and result in surface defects. Rarely are these contaminants captured by thin surface filters, such as nylon monofilament (NMO) bags. Effective deformable contaminant removal requires a rigid depth filter structure. 3M Purification's offerings of Micro-Klean RB series, Betapure BK series and Betapure AU series cartridges retain deformable contaminants in their rigid depth medium through repeated opportunities for capture as the contaminant transits the media structure.

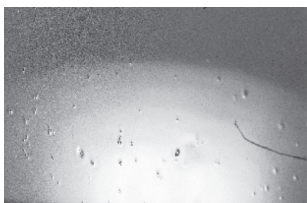

Figure 29 - Cratering and fish eyes on a painted surface.

Haze

Haze removal is difficult, if not impossible, to achieve through simple mechanical sieving. Haze is caused by fine particles, usually sized less than 1 micron, suspended in the resin or a clear coating product. To selectively remove these contaminants by mechanical sieving requires extremely small pores that severely restrict flow entirely. To provide superior haze removal while maintaining excellent flow characteristics, 3M Purification recommends the Zeta Plus™ filter cartridge. The charge-modified medium, formulated for the removal of the suspended fine particles, combines an open structure that mechanically removes large particles, with electrokinetic adsorption to remove the smaller contaminants. Zeta Plus filter cartridges, with fixed pore structure and retention by adsorption, encompass precisely the most effective and efficient removal of haze-producing contaminants.



Figure 30 - Single pass haze removal with Zeta Plus filters.

Selection of the Proper Filter System

Selection of the proper filter is important for the best possible coating quality. 3M Purification brings a wealth of experience to automotive paint filtration.

Absolute rated filters ensure the removal of all oversize and unwanted particles which result in paint defects. Absolute ratings are applied to filters to provide information for the selection of a filter. The method 3M Purification applies to absolute rating is among the highest in the industry. To establish the rating the filter must remove 99.9% of all contaminants at the rated size and larger. The filter must also maintain that performance throughout the filter life. Equally important, desired particles and pigments must pass through the filter. This process is commonly referred to as classification. Betapure™ AU series provides consistent, absolute classification filtration from batch to batch and throughout the filter life.

3M Purification filtration standards are among the highest in the industry.

Figure 31 - 3M Purification's multipoint characterization (MPC) measures removal efficiency throughout the filter life, as shown for a 15 micron absolute rated Betapure™ cartridge.

Figure 32 - A melt-blown filter compresses and unloads captured contaminants as differential pressure increases.

Figure 33 - As differential pressure increases, a bag filter's surface plugs and retains finer and finer pigments. Ultimately, the increased pressure causes contaminant unloading.

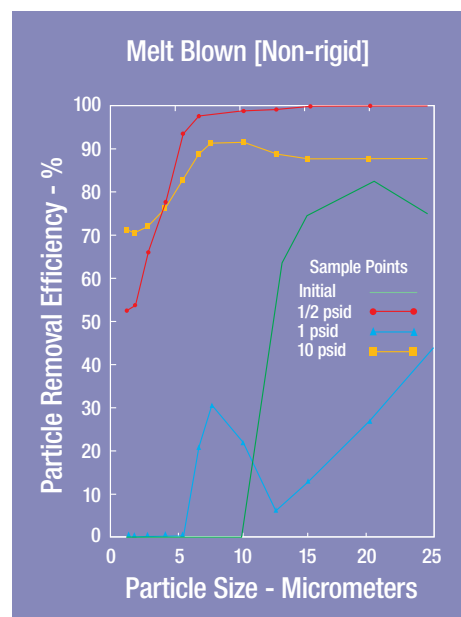
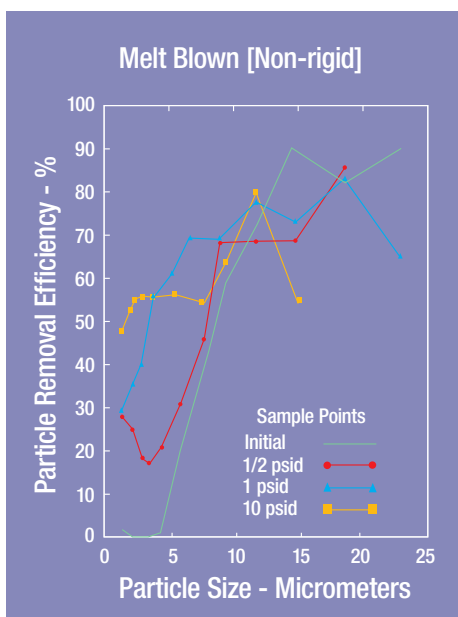
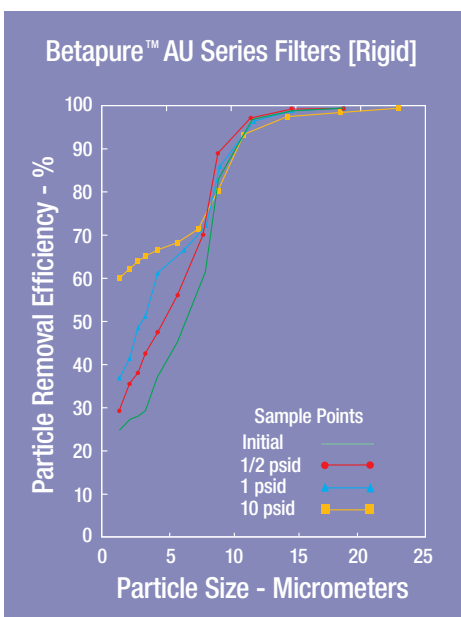

Commonly used filters, such as bag and melt-blown filters, quickly form a “cake” of solids on the surface that increases its particle removal efficiency and differential pressure. As the cake builds, removal efficiency increases. The result is more and more of the finer pigments and desired solids are eliminated, stripping the coating of its desired characteristics.

3M Purification uses a multi-point characterization (MPC) shown in Figure 31. The MPC measures the removal performance over the filter's entire service life and reflects what the filter will actually do from the time it is first installed to the end of its service life. Figures 32 and 33 depict the inconsistent performance of melt blown filters and bags.

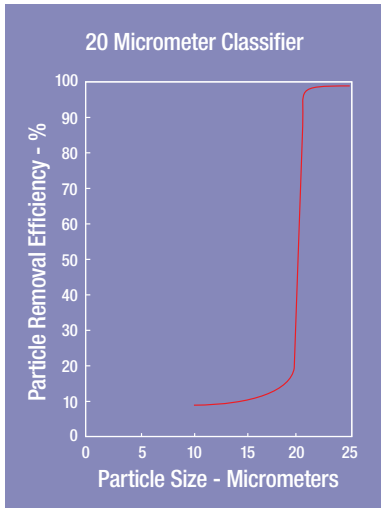

Figure 34 - Curve showing the removal efficiency for a classifying filter. Only particles larger than the rating are removed.

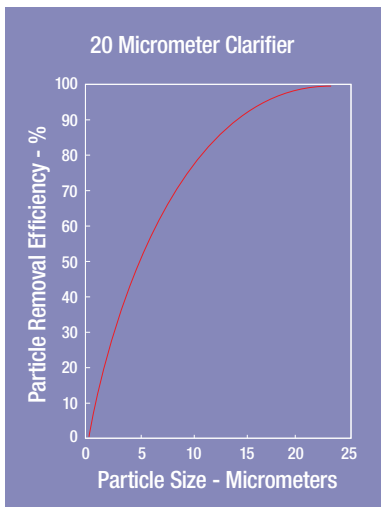

Figure 35 - Curve showing the removal efficiency for a clarifying filter. Pigments and particles smaller than the rating are removed.

Classification versus Clarification

Contaminant particles consist of oversize pigments, gels, fibers, oils, and agglomerates of small particles. Absolute ratings help define the efficiency and removal of particles larger than the rating but in no way inform the user of the ability to remove or let pass smaller, desired particles.

Most paint and coatings applications require that smaller particles such as pigments, metal flakes, micas, or fillers be allowed to pass through the filter. A classifying filter, as shown in Figure 34, removes all unwanted contaminants, 20 microns and larger, while allowing the smaller pigments and desired components to pass through the filter. A clarifying filter, such as a graded-porosity melt blown medium, removes a high percentage of the particles below its rating (see Figure 35). The result is a finished product that:

If the filter is too efficient

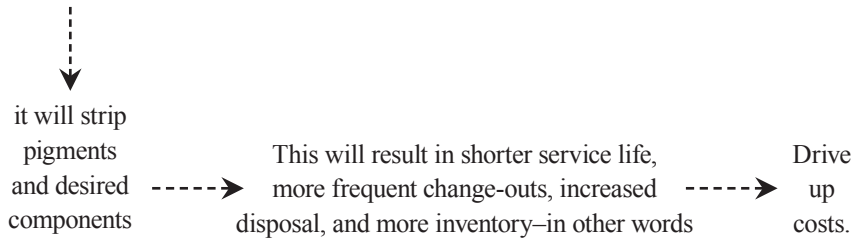

To prevent this problem

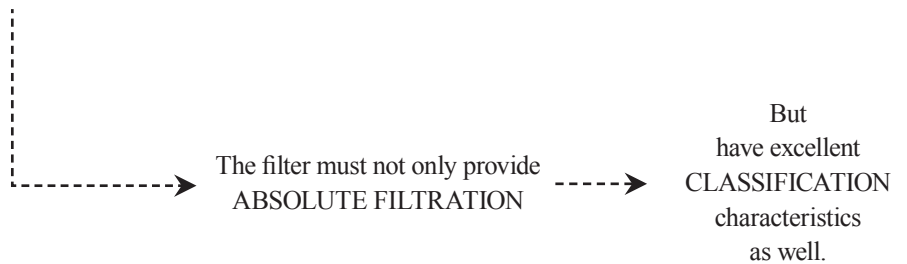

Table 9

Betapure [Depth]	Bags [Surface]	Melt Blown [Depth]
Free of media migration; will remove fibers	Passes and may release fibers	May release fibers
Rigid depth filter removes deformables that cause craters and fish eyes	Passes deformables that cause craters and fish eyes	Filter compresses and can release deformables that cause craters and fish eyes
Excellent depth classification, reduces surface plugging and passes desired pigments	Poor classification, media blinds t and strips pigments	Strips pigments as differential pressure increases and filter compresses

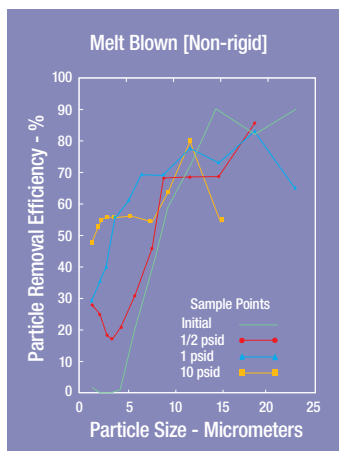

Figure 36 - A melt-blown filter compresses and unloads captured contaminants as differential pressure increases.

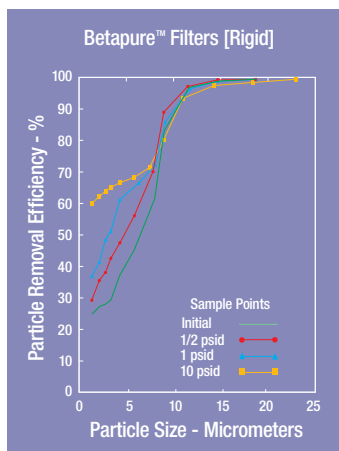

Figure 37 - Betapure's rigid structure maintains consistent removal efficiencies as differential pressure increases.

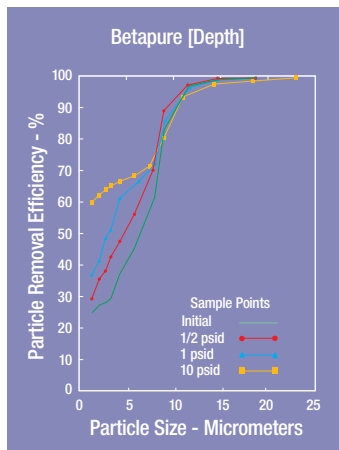

Figure 38 - Betapure™ AU series depth structure eliminates retention of fine pigments caused by surface plugging.

Filter Construction

The filter cartridge construction dramatically impacts overall performance. Two uniquely different constructions should be evaluated.

Non-Rigid versus Rigid Filters

Non-Rigid filters, such as bags and melt blown cartridges, compress and relax with pulsating pumps or pumps that are cycled on and off. These pulsations affect the pore size and alter removal efficiencies. The pores in filters that are non-rigid can compress with increased differential pressure and become more efficient during their life, stripping paint and ink of desired pigments. Most non-rigid filters also exhibit unloading of contaminants once a critical differential pressure is reached. This is a characteristic of wound and some melt blown cartridges (See Figure 36). Rigid filters, such as Betapure™ AU series, maintain the desired filter pore size, regardless of the differential pressure, through their service life, providing consistent and reproducible results (See Figure 37).

Table 10

Betapure Filters [Rigid]	Bags [Non-rigid]	Melt Blown [Non-rigid]
Does not unload or bypass with increased or varying differential pressure	Unloads and bypasses with increased or varying differential pressure	Unloads and bypasses with increased or varying differential pressure
Does not compress and strip pigments or desired components	Expands and releases contaminants	Compresses and strips pigments and desired components
Rigid depth filter removes deformables that cause craters and fish eyes or leave voids in the coating	Passes deformables that cause craters and fish eyes	Filter compresses and can release deformables that cause craters and fish eyes

Depth versus Surface Filters

Depth filters provide many opportunities for a contaminant to be removed from paints and coatings. The long residence time in the tortuous paths of a depth filter increase the likelihood that deformable particles will be captured and retained by the filter.

Surface filters, such as bags, are much less likely to remove deformables. Surface filters also tend to cake quickly, causing the contaminant to form a tight barrier. This process shortens filter life and strips the paint of wanted pigments. Figure 39 shows how a bag surface filter removes a high percentage of smaller particles at 10 psid differential pressure. An equivalent Betapure™ AU series cartridge shown in Figure 38 provides consistent particle removal efficiency throughout the cartridge life.

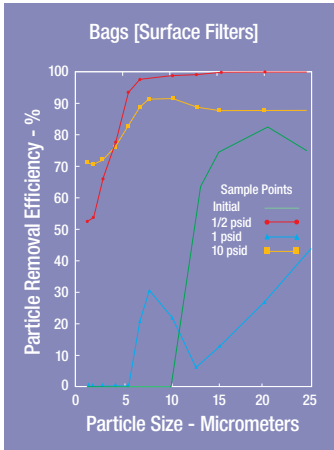

Figure 39 - As differential pressure increases, a bag filter's surface plugs and retains finer and finer pigments. Ultimately, the increased pressure causes contaminant unloading.

Table 11

Betapure [Depth]	Bags [Surface]	Melt Blown [Depth]
Free of media migration; will remove fibers	Passes and may release fibers	May release fibers
Rigid depth filter removes deformables that cause craters and fish eyes	Passes deformables that cause craters and fish eyes	Filter compresses and can release deformables that cause craters and fish eyes
Excellent depth classification, eliminates surface plugging and passes desired pigments or desired components	Poor classification, media blinds and strips pigments or desired components	Strips pigments as differential pressure increases and filter compresses

Table 12 - 3M Purification Filter Structure Matrix

Products	Ratings (micron)		Structure Density		Application		Recommendation
	Absolute	Nominal	Surface	Depth	Uniform	Graded	
Betafine™ XL Series	0.2-50		Yes	1	Yes		Absolute particle removal
							Clarifying filter
							Low contaminant level
							Narrow particle distribution
Micro-Klean™ RB Series		1-150		Yes		Yes	Removal of semi-solids
							Broad particle distribution
Betapure™ BK Series	5-70			Yes		Yes	Absolute particle removal
							Removal of semi-solids
							Broad particle distribution
Betapure™ AU Series	2-170			Yes	Yes		Absolute particle removal
							Classifying filter
							Removal of semi-solids
							Narrow particle distribution
Zeta Plus™				Yes		Yes	Removal of haze and semi-solids

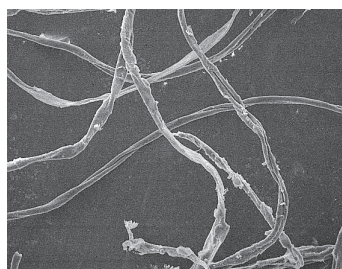

Figure 40 - Betapure™ AU Series – rigid depth classifying filter.

Betapure™ AU Series

A true, absolute-rated classifying filter, Betapure is ideal for pigmented paints and inks. It removes undesirable contaminants while allowing pigments, metallic flakes, micas, and fillers to pass through. Betapure™ AU series is available in a wide range of filter grades, tightly and accurately rated for narrowly differentiated filtration needs.

The rigid structure eliminates pore size changes, unloading, and bypass that are common with other filters. Betapure is supplied in polyolefin or polyester based materials—both compatible with automotive paints.



Betapure™ AU Series Product Advantages

- Improves yields by selectively passing desired pigments, metal flakes, and mica; superior classification characteristics of Betapure™ AU series.
- Contaminants will not unload or bypass into the paint; rigid non-deformable filter structure
- Removes oversize particles that result in rejected paint; absolute rated
- Removes gels and deformables that cause craters and fish eyes; depth filter structure
- Eliminates fibers from paint; free of media migration
- Eliminates filter change-outs during the batch; increased filter service life

Figure 41 - SEM Photomicrograph of Betapure's internal structure. Multiple bond points and the bicomponent fibers produce a rigid depth filter matrix.

Betapure™ AU Series Construction

Betapure AU series utilizes state of the art fiber technology combined with innovative process technology to provide a clean, rigid filter structure with consistent and reproducible filtration characteristics. Betapure AU series is constructed using long bicomponent fibers. The fiber's outer sheath melts at a lower temperature than the fiber's inner core. When heated, a matrix of these fibers becomes permanently bonded in a three dimensional network. The high degree of fiber-to-fiber bonding eliminates both the need for a core support and any possibility of media migration. The matrix is consistent and rigid, as seen in the photomicrograph, Figure 41.

For more information please ask for 3M Purification literature number LITCBP001.

Table 13 - Betapure™ Cartridges

Cartridge Type	Length (inches)	Grade	Absolute Rating (µm)	Media	End Modifications	Gasket/O-ring
Betapure™ AU Series	9 3/4	A*	6	Polyolefin or Polyester	Code 7 Bayonet Lock Code 8 Double O-Ring Double Open End w/Hard Cap 10" Nom. Length Double Open End w/Hard Cap 9 3/4" Nom. Length Code 3 Double O-ring Code 3 Double O-ring w/ Polypropylene Snap Ring	Silicone Fluorocarbon EPR Nitrile Polyethylene**
	10	Z 070	7			
	19 1/2	Z 100	10			
	20	Z 120	12			
	29	Z 150	15			
	30	B	20			
	39	C	30			
	40	E	40			
		G	70			
		L**	90			
		Q**	100			
		V**	140			
	W**	160				
X**	190					



Betapure™ BK Series

Absolute rated Betapure™ BK series is a rigid, graded porosity filter cartridge constructed of acrylic and cellulose fibers, bound together with a chemically resistant thermosetting resin. Betapure BK series cartridges are grooved to significantly increase surface area and greatly extend service life. Betapure BK series is manufactured to absolute ratings and tested to deliver quality, consistency, and cost effective filtration performance. Betapure BK series is recommended for filtration of high viscosity resins, inks and electrodeposition paints.

Figure 42 - Betapure™ BK Series – rigid graded-porosity cartridge filter.

Performance

The initial Beta Ratio for all grades of Beta-Klean filter cartridges is equal to or greater than 1000, and each cartridge performs at or above Beta 1000 throughout its usable life! Filters that show a decrease in Beta Ratio as the differential pressure increases are exhibiting either unloading of previously held contaminants or loss of filtration efficiency (Figure 43). Resulting inconsistent performance will cause a reduction in finished product quality, and increased filtration time.

Betapure™ BK Series Advantages

- Prevents contaminant unloading and bypassing into the product—rigid non-deformable filter structure
- Achieves longer service life with engineered groove design—enhanced filter surface area
- Reduces disposal costs by elimination of steel cores – simplifies incineration and shredding

For more information please ask for 3M Purification literature numbers LITCBK001 and LITCBK002

Figure 43 - Beta Ratio Comparison of Filter Cartridges Rated at 20 Microns

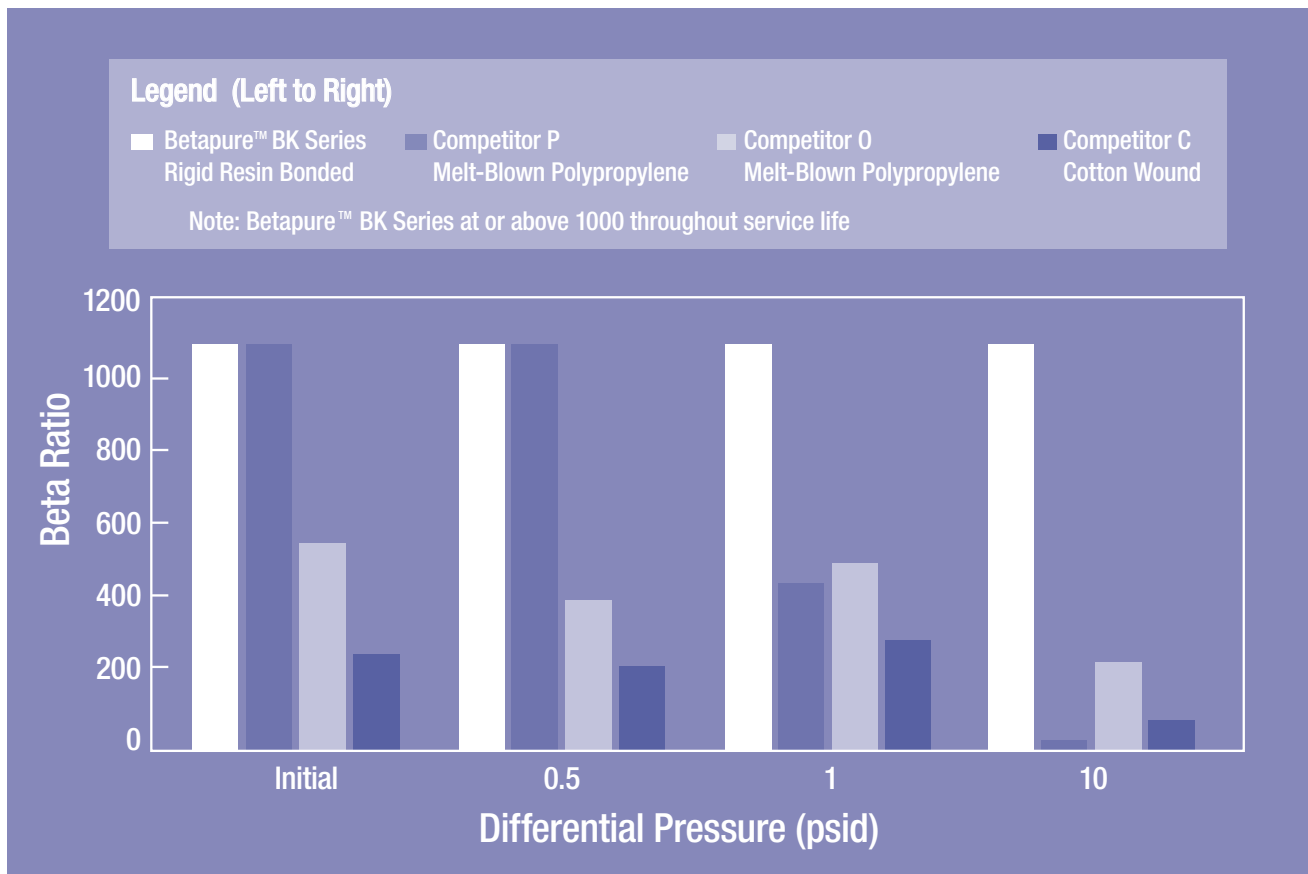

Table 14 - Betapure™ BK Series Cartridges

Cartridge Type	Length (inches)	Micron-Grade	Surface	Packaging	Temperature Option	End Modifications	Gasket/O-ring
Betapure™ BK Series	9 3/4	Z8050-5	Grooved or Ungrooved	Standard, Shrink Wrap, or Bulk Pack	Standard or High Temp.	222 O-ring & Spear 222 O-ring & Flat Cap 222 O-ring, Retaining Clip & Flat Cap Endcap with Stainless Spring Polypropylene Core Extender SS Core Extender	Silicone Fluorocarbon EPR Nitrile Volara Gasket
	10	Z8070-7					
	19 1/2	Z8100-10					
	20	Z8140-14					
	29 1/4	Z8150-15					
	30	Z8200-20					
	39	Z8300-30					
	40	Z8400-40					
		Z8500-50					
		Z8700-70					
		Z2100-10					
		Z2200-20					
		Z2300-30					
		Z2400-40					
Z2600-60							

Zeta Plus™ Filters

Difficult resin filtration applications need the Zeta Plus™ family of charge-modified depth media. Zeta Plus combines mechanical sieving and electrokinetic adsorption to remove deformables and colloidal hazes that would be difficult or impossible to filter with bags or conventional filtration systems.

Zeta Plus™ Advantages

- Eliminates craters and fish eyes; rigid depth media
- Removes haze in a single pass; charge modified filter media
- Increases production by reducing the need for resin recirculation; no more bypass
- Eliminates product leakage; enclosed filter systems
- Simplifies operator service; easy to use cartridge filter and housing

For more information on Zeta Plus cartridges, contact your local 3M Purification Distributor.



Figure 44 - Zeta Plus™ filter cartridges are available in a broad range of sizes.

The Zeta Plus™ Cartridge System

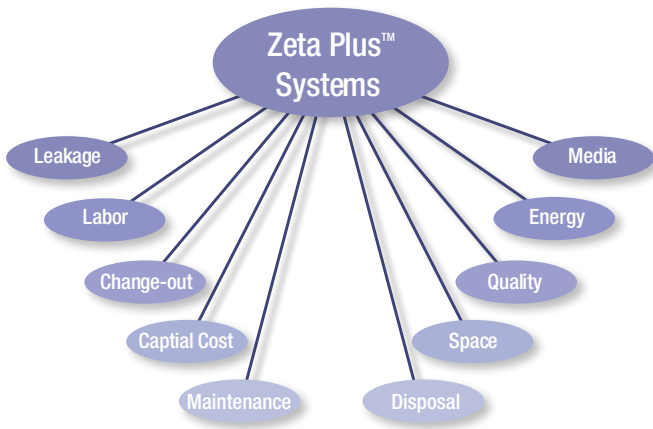

Saves on product loss

Zeta Plus™ cartridges are contained in a totally enclosed, sanitary filter housing to eliminate any chance of leakage.

Saves on labor

A Zeta Plus cartridge system can be changed out in 15 minutes compared to much longer change out times for a filter press (4-8 hours or longer for large presses).

Saves on media change-outs

Zeta Plus cartridges are used to 35 psid without bypass, resulting in fewer change-outs when compared to sheet filters in a filter press.

Saves on maintenance

Zeta Plus systems have only one set of O-rings to maintain, resulting in easy upkeep. Filter presses have many O-rings/gaskets to stock, maintain and replace.

Saves on capital costs

For comparable flow rates, a typical Zeta Plus system housing costs less than one half of a stainless steel filter press.

Table 14 - Betapure™ BK Series Cartridges

Cartridge Type	Cartridge Diameter (inches)	Gasket Material	Media Grade
Zeta Plus™ U Series	12 (305mm)	Nitrile	05
		Neoprene	
		Cork	10
A Series	12 (305mm)	Nitrile	01
		Neoprene	05
		Fluorocarbon	10
		EPR	20
		Cork	30

Zeta Plus™ Filter Systems

Zeta Plus™ Filter Systems

Zeta Plus™ filters are contained in totally enclosed filter housings that set the standard for quality, performance and ease of use. Benefits of the housing system include:

- A full range of housing sizes to provide easy scale-up from bench-top to pilot scale to full production as your application grows
- A positive spring-loaded cartridge to housing sealing system that provides proper sealing compression to prevent filter bypass even under the most arduous process conditions
- Housing seals, fast action bolts or clamps, that permit rapid assembly and cartridge change-outs to minimize downtime and ensure operator safety
- Complete systems, including piping, valves, and pressure gauges source system solutions, are available



Figure 45 - Zeta Plus™ P Series industrial filter housings (see page 35).



Figure 46 - Zeta Plus™ filter housings can be skid mounted for even more flexibility.

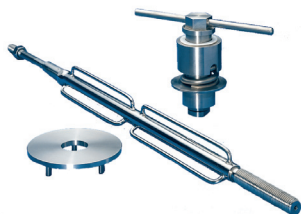

Figure 47 - Simple to install, only three components convert a sparkler press to the performance of Zeta Plus™!

Zeta Plus™ Sparkler Press Retrofit Kit

3M Purification also offers a Zeta Plus retrofit kit for using Zeta Plus filters in a Sparkler Press. This significantly improves upon the Sparkler press design, dramatically improves filtration, and drastically reduces labor and time required for filter change-out.

Typical Savings are:

- 1/8 Labor costs
- 1/6 Disposal cost
- 1/10 Lost product

Table 16 - Benefits of using the Zeta Plus™ cartridge in the Sparkler press.

Process Issues	Zeta Plus	Sparkler Presses
Bypass	Eliminated by Positive Seal	No Positive System Seal
Change-out	Simple Cartridge Design (15 Minutes)	Difficult - Requires a Hoist (2 Hours)
Resin Quality	Superior Single Pass Quality	Requires Continual Recirculation
Disposal	Simple, Easy, Convenient Cartridge Design	Messy Paper and Precoat Handling and Disposal
Resin Waste	Minimal Resin Loss	Typical Loss 7 Times Greater Than Zeta Plus
Safety Leakage	Improved User Friendly Change-out	Heavy System Change-out with Significant Reduced Exposure, Eliminate Leakage and Operator Exposure

Micro-Klean™ RB Series

The exclusive Micro-Klean™ RB series manufacturing process produces a rigid, resin bonded, graded porosity structure that eliminates by-pass and unloading characteristics of soft and easily deformable competitive filters such as bags, spiral wound, melt-blown and string wound cartridges. For applications where the temperature is elevated, up to 300°F, a high temperature cartridge is available. The design of Micro-Klean™ RB series provides a family of filter cartridges that offer distinct advantages.

Micro-Klean™ RB Series Advantages

- Consistent particle removal efficiencies with sharp cut-offs
- Increased filter service life—high area grooved media
- Ability to withstand high temperatures and elevated differential pressures
- Broad chemical compatibility
- Consistent batch-to-batch filtration characteristics

For more information please ask for 3M Purification literature number LITCMK.



Figure 48 - Micro-Klean™ RB Series Filter Cartridge

Table 17 - Micro-Klean™ RB Series Cartridges

Standard Micro-Klean™ RB Series Surface Type	Length* (inches)	Designation		Formulation**	Media		
		Grade	Rating				
Grooved or Ungrooved	9 3/4 or 10	Y	1 µm	8	Polyethylene Gasket 316 S.S. Core Extender Polypropylene Core Extender Shrink Wrap Tissue Wrap		
		A	3 µm	2, 3, 8			
		B	5 µm	2, 3, 8			
		C	10 µm	8			
		F	25 µm	2, 3, 8			
		L	50 µm	2, 3, 8			
		Q	75 µm	8			
		V	100 µm	8			
		W	125 µm	8			
		X	150 µm	8			
High Temperature Micro-Klean™ RB Series Surface Type	Length* (inches)	Designation		Formulation**	Temperature Options	End Treatments	Gasket/O-ring
		Grade	Rating				
Grooved or Ungrooved	9 3/4 or 10	Y	1 µm	8	H - High Temperature	316 S.S. Core Extender SOE 226 Bayonet Lock SOE 222 O-ring & Fin SOE 222 O-ring & Fin Cap	Silicone Fluorocarbon EPR Nitrile
		A	3 µm	8			
		B	5 µm	8			
		C	10 µm	8			
		F	25 µm	8			
		L	50 µm	8			
		Q	75 µm	8			
		V	100 µm	8			
		W	125 µm	8			
		X	150 µm	8			



Figure 49 - Betafine™ XL Series Pleated Polypropylene Filter Cartridge

Betafine™ XL Series

Betafine™ XL series is a highly efficient economical pleated polypropylene filter with large surface area. It is especially suited for filtration of low-viscosity solvents and water.

Betafine™ XL Series Advantages

- Absolute rated filter media removes a broad range of contaminants
- Increases filter service life—high surface area pleated media
- Reduces filter time—high surface area, high flow capacity of the filter
- Meets the application requirements—chemically compatible polypropylene construction
- Increased profitability—minimizes downstream filtration costs and quality problems

For more information please ask for 3M Purification literature number LITCBFXL.

Table 18 - Betafine™ XL Series Cartridges

Cartridge Type	Length* (inches)	Media	Absolute Rating (µm)	End Modification	Gasket or O-ring Material
Betafine™ XL Series	9 3/4	Polypropylene	0.2	Bayonet Lock SOE (226 - O-ring & Spear) Push-in Type SOE (222 O-ring & Spear) Double open end (DOE) Push-in Type SOE (222 O-ring & Cap) DOE + Polypropylene Core Extender	Silicone Fluorocarbon EPR Nitrile PTFE
	10		0.5		
	19 1/2		1.0		
	20		8		
	29 1/4		2.5		
	30		10		
	39		20		
	40		40		
			70		



Figure 50 - 3M™ Activated Carbon Filter Cartridge

3M™ Activated Carbon Cartridge

3M™ Activated carbon cartridges for deionized water prefiltration remove turbidity along with chlorine and trihalomethane (THM). Each cartridge contains 33 cubic inches (540 cm³) of premium grade activated carbon to adsorb dissolved organics and chlorine. An integral five micron prefilter and postfilter are included to remove sediment.

3M™ Activated Carbon Cartridge Advantages

- Provides maximum service life of DI resin beds—high volume of carbon that will not permit fluid channeling
- Built-in prefilters and post filter—eliminates solids that prematurely plug the carbon
- Meets all flow rate requirements—allows for cartridge stacking

For more information please ask for 3M Purification literature number LITAC.

Table 19 - 3M™ Activated Carbon Cartridge Options

Cartridge	Part Number	Length	Diameter
AC	46332-01	9 3/4"	2 3/4" (70mm)



Figure 51 - 3M™ ES Series Filter Housing

Filter Housings

The filter housing dictates how a cartridge seals, how easy the system is to clean, how much the operator is exposed to harmful chemicals, how easy filter change-out is, how much labor is used, and how much product is lost. 3M Purification offers a full line of housings that address these concerns to provide the most cost-effective filtration systems in the industry.

3M™ ES Series Filter Housings

3M™ ES series filter housings are ASME Code vessels available in carbon steel, 304L or 316L stainless steel and a broad range of sizes to match the filtration needs of ink, paint and resins. ES housings have a heavy duty cover lifting device and swing bolt cover fasteners to facilitate easy cover removal and cartridge change-out.

3M™ ES Series Filter Housings Advantages

- Durable construction for long service life
- Easy access for filter removal – swing bolts and cover lifting device
- Flexible housing design – accepts a wide range of industrial filter cartridges
- Easy maintenance and cleanup – few parts to clean
- Meets plant safety requirements – ASME Code design housing

For more information please ask for 3M Purification literature number LITCHSES1.

Table 20 - 3M™ ES Series Filter Housings for Betapure™ AU Series and Betapure™ BK Series Cartridges

Housing Model	Housing Diameter (inches)	Number of Cartridges	Length x 10" nom.	Material	Pressure Rating	Outlet Location	Cover Fastener	Gasket Material
Express Series	8 (203mm)	6	2, 3, or 4	Carbon Steel, 304L S.S., or 316L S.S.	150 psi (10 bar) or 300 psi (20 bar)	Bottom or Side	Bolt or Fast Hex	Nitrile EPR Fluorocarbon PTFE Encapsulated fluorocarbon
	12 (305mm)	12						
	14 (356mm)	18						
	16 (406mm)	24						
	20 (508mm)	36						
	24 (610mm)	52						
	30 (762mm)	85						
Z8400-40	120							

Table 21 - 3M™ ES Series Filter Housings for Zeta Plus™ Cartridges

Housing Model	Housing Diameter (inches)	Number of Cartridges	Material	Pressure Rating	Outlet Location	Cover Fastener	Gasket Material
Express Series	16 (406mm)	3-12" Ctgs	Carbon Steel, 304L S.S., or 316L S.S.	150 psi (10 bar) or 300 psi (20 bar)	Bottom or Side	Bolt or Fast Hex	Nitrile, EPR, Fluorocarbon, or PTFE Encapsulated fluorocarbon
	20 (508mm)	3-16" Ctgs					
	36 (914mm)	12-12" Ctgs					



Figure 52 - 3M™ DC Series Filter Housing

3M™ DC Filter Housings

3M™ DC series filter housings are constructed of 304L stainless steel in a range of sizes to meet all flow rate requirements. 3M DC series filter housings have a simple band clamp design for easy, rapid assembly, ideal for process water filtration.

3M™ DC Series Filter Housing Advantages

- Quick and easy cartridge change-out—single V-band clamp closure
- Easy maintenance and cleanup—few parts to clean
- Easy installation to assure alignment and positive seal—single upper seal plate
- Excellent durability and service life—all stainless steel construction

For more information please ask for 3M Purification literature number LITHSDCI.

Table 22 - 3M™ DC Series Filter Housings

Housing Model	Standard Housing Part Number	Number of 10" (254mm) Cartridges
4DC1	44258-01	4
4DC2	44258-02	8
4DC3	44258-03	12
5DC1	44254-01	5
5DC2	44254-02	10
5DC3	44254-03	15
5DC4	44254-04	20

Housing Model	Standard Housing Part Number	Number of 10" (254mm) Cartridges
12DC2	44078-02	24
12DC3	44078-01	36
22DC3	44427-01	66
22DC4	44427-02	88



Figure 53 - 3M™ CT Series Filter Housings

3M™ CT Series Filter Housings

The 3M™ CT series filter housings are three-piece, all-metal housings with ring nut closures. A single ring nut accesses the spent filter for easy removal and housing cleaning. The rugged, yet compact CT design is ideally suited for filtration of solvents and other paint components. They house a single cartridge in three nominal lengths, 9 3/4", 19 1/2" and 29 1/4".

3M™ CT Series Filter Housing Advantages

- Easy maintenance and cleanup—few parts to clean
- Reduces labor and production delays—easy, rapid filter change-out housing design
- Excellent durability and service life—constructed of stainless steel wetted parts
- Single O-ring design for reliable sealing

Table 23 - 3M™ CT Series Filter Housings

Housing Model	Standard Housing Part Number	Inlet/Outlet	Cartridge Length (inches)	Housing Material	Mounting Bracket Kit
CT101A	47310-04	1" NPT	9 3/4	All 316 S.S. with vent	66984-01
CT102A	47310-05	1" NPT	19 1/2		
CT103A	47310-06	1" NPT	29 1/4		

3M™ CT Series Filter Housings with sanitary flanges are also available



CUNO™ CTG-Klean Systems

The CUNO™ CTG-Klean system offers optimum benefits for coating filtration. It provides totally enclosed filtration using a separate pressure vessel and filter pack to isolate the ink or paint from the housing. This highly efficient system reduces labor for filter change-out and cleaning. This is particularly important when processing waterborne paints because they are especially difficult to clean from metal housings and components.

CUNO™ CTG-Klean System Advantages

- Minimizes labor—rapid change-out design
- Eliminates paint bypass—factory sealed filter pack

Figure 54 - CUNO™ CTG-Klean System: the filter pack provides the barrier between the paint and the housing, reducing change-out times and operator exposure.

- Minimizes operator exposure – totally enclosed filter pack
- Reduces solvent waste and handling – no housing to clean
- Meets flow requirements – designs accommodate one to twenty-one 10-inch filter cartridges
- Meets plant regulatory requirements – ASME Code design to 300 psi (21 bar)

CUNO™ CTG-Klean filter packs are available with Betapure™ AU series, Betapure™ PK series, Micro-Klean™ RB series, Betafine™ XL series and other filter cartridges. For more information please ask for 3M Purification literature number LITCCK001.

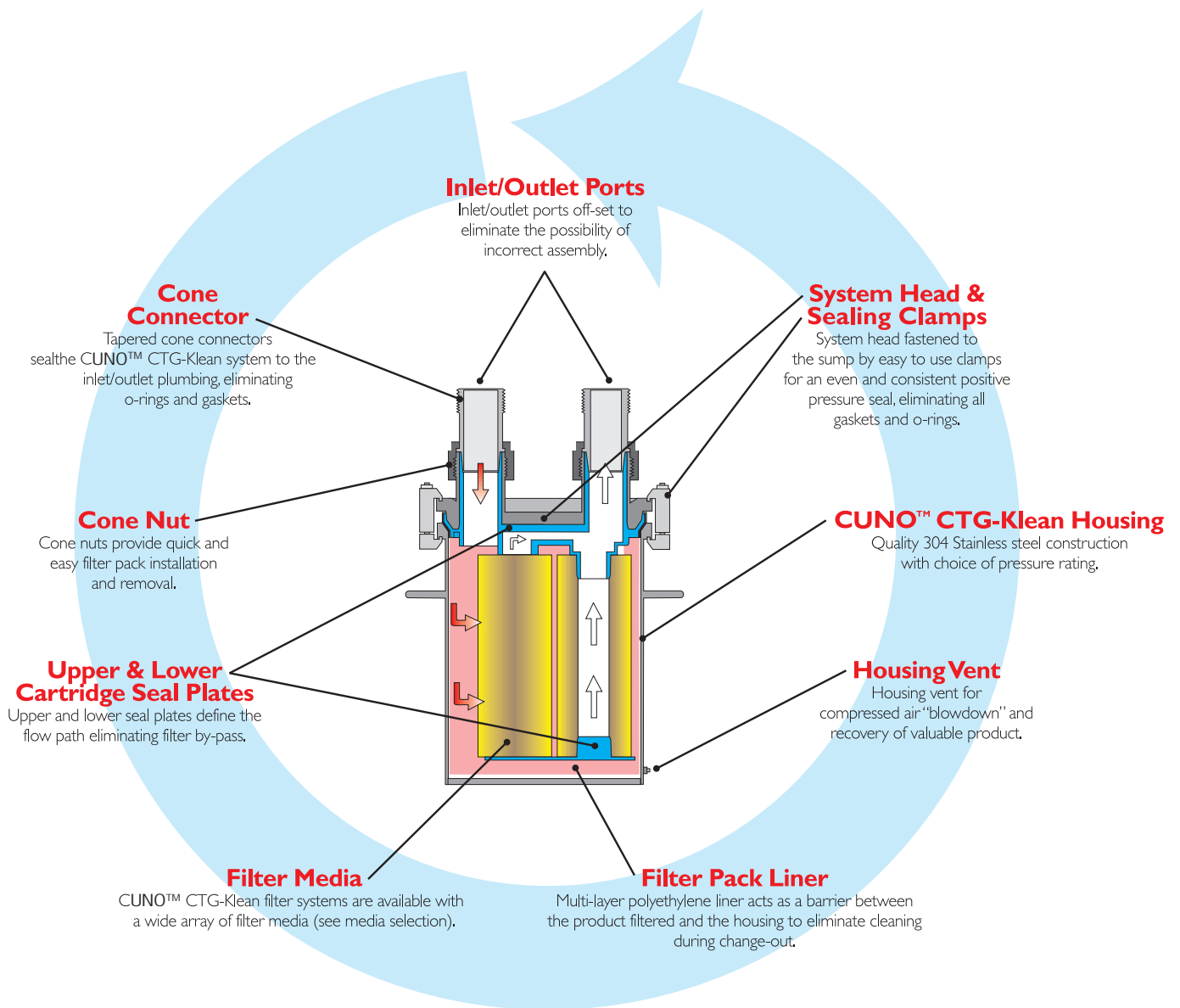

Table 24 - CUNO™ CTG-Klean Housings

Housing Model	Std. Housing Part Number	Inlet/Outlet	Material	Maximum Operating Pressure & Temperature	Filter Pack Configuration	Nominal Cartridge Length (inches)
Standard Design						
1WTS1	16 (406mm)	1/2" NPT	304 S.S.	145 psi @ 158°F (10 bar @ 70°C)	1 Cartridge by 1 High	10
1WTS2	20 (508mm)				1 Cartridge by 2 High	20
3WTS1	47049-01	1" NPT	304 S.S.	145 psi @ 158°F (10 bar @ 70°C)	3 Cartridge by 1 High	10
3WTS2	47049-02				3 Cartridge by 2 High	20
3WTS3	47049-03				3 Cartridge by 3 High	30
7WTS1	47050-01	1-1/4" NPT	304 S.S.	232 psi @ 158°F (16 bar @ 70°C)	7 Cartridge by 1 High	10
7WTS2	47050-02				7 Cartridge by 2 High	20
7WTS3	47050-03				7 Cartridge by 3 High	30
1 45/150 lb ASME Code Design						
3WTS1	47113-01	1" NPT	304 S.S.	145 psi @ 160°F (10 bar @ 71°C)	3 Cartridge by 1 High	10
3WTS2	47113-02				3 Cartridge by 2 High	20
3WTS3	47113-03				3 Cartridge by 3 High	30
7WTS1	47137-01	1-1/4" NPT	304 S.S.	150 psi @ 160°F (10 bar @ 71°C)	7 Cartridge by 1 High	10
7WTS2	47137-02				7 Cartridge by 2 High	20
7WTS3	47137-03				7 Cartridge by 3 High	30

Table 25 - CUNO™ CTG-Klean Filter Packs

Betapure™ AU Series Filter Packs					
Cartridges in Pack	Cartridge Length	Cartridge Type	Grade Code	Nominal Rating (mm)	Absolute Rating (mm)
1* 3 7	1 High - 10"	Betapure	B	5	20
			C	10	30
			E	20	40
	2 High - 20"		G	30	70
			L	50	90
			Q	75	100
	3 High - 30"		V	100	140
			W	150	160
			X	175	190

* Not available in 3 high (30") cartridge length

Table 25 Continued

Betapure™ BK Series Filter Packs						
Cartridges in Pack	Cartridge Length	Cartridge Type	Cartridge Material	Grade Code	Absolute Rating (mm)	Surface Type
1* 3 7	1 High - 10" 2 High - 20" 3 High - 30"	Betapure™	Acrylic/Cellulose Fibers with Phenolic Resin binder	Z8050	5	Grooved or Ungrooved
				Z8070	7	
				Z8100	10	
				Z8140	14	
				Z8150	15	
				Z8200	20	
	Z8300		30			
	Cellulose Fiber with Melamine Resin binder		Z2100	10		
			Z2200	20		
			Z2300	30		
Z2400		40				
Z2500	60					

* Not available in 3 high (30") cartridge length



Figure 55 - 3M™ 7PC Cartridge Pack Filter Housing

3M™ 7PC Series Filter Housings

3M™ 7PC series cartridge pack filter housings are designed for applications in which ease of use and rapid cartridge change-out are required. The cartridge installation method and diaphragm design provide easy cartridge loading and housing cleanup.

3M™ 7PC Series Advantages

- Quick and easy cartridge change-out – preassembled packs permit rapid installation and removal of cartridges
- Reduced operator exposure – assembled cartridge pack eliminates need to individually handle the filter cartridges
- Easy to clean housing design – complete access to dirty and clean side chambers
- Compatible materials of construction – available in carbon or 316 stainless steel construction

For more information please ask for 3M Purification literature number LITHS.PC2.

Table 26 - 7PC Housings

Model	Standard Housing Part Number	Housing Material	Cartridge Pack Assembly Model	Cartridge Pack Assembly Part Number
7PC1	44124-01	316 Stainless Steel	316 Stainless Steel	44126-03
7PC2	44124-02	316 Stainless Steel	316 Stainless Steel	44126-04
				47062-01
7PC1	44123-01	Steel	Steel	44126-03
7PC2	44123-02	Steel	Steel	44126-04
				47062-01



Figure 56 - 3M™ AL Series Cartridge Pack Filter Housing

3M™ AL Series Filter Housings

The 3M™ AL series filter housing is constructed from durable low-cost cast iron and steel. The three piece design is easy to clean and will satisfy the requirements of a wide range of applications.

3M™ AL Series Filter Housing Advantages

- Rugged, low cost cast iron and steel for economy
- Greater cartridge flexibility—will accept modular cartridges from 9 3/4" to 10"
- Easy to assemble/disassemble for quick cartridge change-out and cleaning

For more information please ask for 3M Purification literature number LITHS.AL1.

Table 27 - 3M™ AL Series Filter Housings

Model Number	Standard Housing Part Number	Number of Cartridges (10" elements)
3AL1	44079-01	3
3AL2	44079-02	6
3AL3	44079-03	9
6AL1	44080-01	6
6AL2	44080-02	12
6AL3	44080-03	18

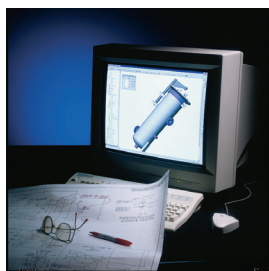

Figure 57 - Advanced computer aided design combined with computer aided manufacturing allows for custom housings within the standard manufacturing cycle.

Custom Filter Housing Designs

Advanced computer aided design and computer integrated manufacturing technologies ensure compliance with design standards while allowing production of custom configurations in the standard manufacturing process. Working with the customer, 3M Purification technical sales engineers can ensure that specific client requirements for both design and delivery are met.

For more information about custom housings, contact your local 3M Purification Distributor.

Applications Support - SASS

Working within state-of-the-art filtration laboratories, 3M Purification's Scientific Applications Support Services (SASS) department is staffed with highly trained scientists and engineers who are prepared to evaluate problems and recommend the proper filter solution. SASS staff, familiar with coatings filtration applications, works closely with customer applications in order to recommend the most effective and economical 3M Purification filtration system. The 3M Purification laboratory is equipped with a full range of instrumentation such as a Scanning Electron Microscope (SEM) and Fourier Transform Infrared Spectroscopy, (FTIR) to investigate the type and source of paint contaminants.



Figure 58 - 3M Purification's Filtration Field Test Kit

- Paint Laboratory
- Full Technical Support
- On-Site Testing
- Evaluate Results
- Start up Support
- Paint Contaminant Evaluation

Addressing Growing Environmental Concerns

There is a continued effort within the paint and coatings industry to reduce disposal costs. 3M Purification has a complete offering of products to address this growing issue. Betapure™ AU series and Betapure™ BK series have long service lives which reduce both the number of filters needed and disposal costs in general.

Solvent volumes for cleaning are best controlled by long filter life and by the use of a housing system that virtually eliminates cleaning. CUNO™ CTG-Klean was developed as a self contained system to eliminate product contact with the housing, reducing solvent usage for cleaning by up to 80%. The enclosed filter pack greatly reduces operator exposure. The easy to use CUNO CTG-Klean combination simplifies change-out and reduces down time to a minimum.

Betapure AU series and Betapure BK series filter elements are coreless filters which allows for ease of shredding, minimizing disposal costs. Incineration can be a recommended option and the ease of incineration is enhanced by the high BTU values (per 10" element) as shown in Table 29.

Table 29 - Heating Values per 10" Element

Betapure™ BK Series	8,000 BTU
Betapure™ AU Series	19,900 BTU
#4 Fuel Oil	18,500 BTU

Over 100 Years of Solutions

When looking for a solution to challenging paint and coatings filtration, the industry has turned to 3M Purification for performance. 3M Purification has achieved a leadership position by striving to be the best supplier of high quality products designed to provide cost effective solutions.

Some filter manufacturers offer a limited range or a single filter option. 3M Purification, however, understands that each application is unique and there is always an alternative. 3M Purification has both the experience and the breadth of products to provide quality improvements and dramatic cost savings for the customer.

Service Worldwide

3M Purification is a multinational organization with global manufacturing facilities for consistent product quality and immediate availability. Through an extensive network of trained distributors and field technical specialists familiar with the dynamics of ever-changing paint and coatings manufacturing methods, 3M Purification provides proven filtration technologies to assist in today's total quality manufacturing environment.

The Commitment

3M Purification understands that the best solutions begin with a thorough awareness of the problem and recognizes that each customer's manufacturing process is unique. The goal is to understand both customer objectives and process requirements, and to recommend solutions to meet customer needs.



Figure 59 - 3M Purification's Paint Laboratory for Contaminant Analysis





Important Notice

The information described in this literature is accurate to the best of our knowledge. A variety of factors, however, can affect the performance of the Product(s) in a particular application, some of which are uniquely within your knowledge and control. **INFORMATION IS SUPPLIED UPON THE CONDITION THAT THE PERSONS RECEIVING THE SAME WILL MAKE THEIR OWN DETERMINATION AS TO ITS SUITABILITY FOR THEIR USE. IN NO EVENT WILL 3M PURIFICATION INC. BE RESPONSIBLE FOR DAMAGES OF ANY NATURE WHATSOEVER RESULTING FROM THE USE OF OR RELIANCE UPON INFORMATION.**

It is your responsibility to determine if additional testing or information is required and if this product is fit for a particular purpose and suitable in your specific application.

3M PURIFICATION INC. MAKES NO REPRESENTATIONS OR WARRANTIES, EITHER EXPRESS OR IMPLIED INCLUDING WITHOUT LIMITATION ANY WARRANTIES OF MERCHANTABILITY, FITNESS FOR A PARTICULAR PURPOSE OR OF ANY OTHER NATURE HEREUNDER WITH RESPECT TO INFORMATION OR THE PRODUCT TO WHICH INFORMATION REFERS.

Limitation of Liability

3M Purification Inc. will not be liable for any loss or damage arising from the use of the Product(s), whether direct, indirect, special, incidental, or consequential, regardless of the legal theory asserted, including warranty, contract, negligence or strict liability. Some states do not allow the exclusion or limitation of incidental or consequential damages, so the above limitation may not apply to you.



3M Purification Inc.
400 Research Parkway
Meriden, CT 06450, U.S.A.
Tel (800) 243-6894
(203) 237-5541
Fax (203) 630-4530
www.3mpurification.com

Your Local Distributor:

3M is a trademark of 3M Company.
Betapure, Zeta Plus, Micro-Klean and Betafine are
trademarks of 3M Company used under license.

© 3M 2011. All rights reserved.

LITCATCRC1 1111b



Innovative Filtration Solutions

Quality. Consistency. Performance.