

RTO 5-T-TC - Test disconnect terminal block



3049990

<https://www.phoenixcontact.com/us/products/3049990>

Please be informed that the data shown in this PDF document is generated from our online catalog. Please find the complete data in the user documentation. Our general terms of use for downloads are valid.



Test disconnect terminal block with bolt connection technology and transparent safety contact hood, cross section: 0.1 - 6 mm², AWG: 26 - 10, width 16.3 mm, color: gray

Your advantages

- Four bridge shafts per terminal block
- Terminal point always freely accessible
- Easy bridging and potential distribution using the patented plug-in bridges from the CLIPLINE complete system
- The screws are secured against loosening by captive spring-loaded spacers
- Large-surface labeling options in the terminal center and above the terminal points
- The use of the switching lock effectively prevents unintentional switching

Commercial data

Item number	3049990
Packing unit	25 pc
Minimum order quantity	25 pc
Sales key	BE43
Product key	BE4333
Catalog page	Page 382 (C-1-2019)
GTIN	4046356431408
Weight per piece (including packing)	43.54 g
Weight per piece (excluding packing)	37.16 g
Customs tariff number	85369010
Country of origin	CN

RTO 5-T-TC - Test disconnect terminal block



3049990

<https://www.phoenixcontact.com/us/products/3049990>

Technical data

Notes

General	Note: the BE-RT... path extension is to be used for non-insulated cable lugs (see accessories).
---------	---

Product properties

Product type	Bolt connection terminal block
Number of connections	2
Number of rows	1
Potentials	1

Data management status

Article revision	01
------------------	----

Insulation characteristics

Overvoltage category	III
Degree of pollution	3

Electrical properties

Rated surge voltage	6 kV
Maximum power dissipation for nominal condition	1.31 W

Connection data

Number of connections per level	2
Nominal cross section	6 mm ²
Stripping length	The stripping length depends on the specification provided by the cable lug manufacturer.
Connection in acc. with standard	IEC 60947-7-1
Nominal current	41 A
Maximum load current	41 A (with 6 mm ² conductor cross section)
Nominal voltage	500 V
Nominal cross section	6 mm ²

Disconnect slide

Screw thread	M4
--------------	----

Cable lug connection DIN 46234:1980-03

Connection in acc. with standard	DIN 46234:1980-03
Cross section	0.5 mm ² ... 6 mm ²
Cross section range AWG	20 ... 10 (converted acc. to IEC)
Hole diameter	5.3 mm
Width	10 mm
Bolt diameter	5 mm
Screw thread	M5
Tightening torque	2.5 ... 3 Nm

RTO 5-T-TC - Test disconnect terminal block



3049990

<https://www.phoenixcontact.com/us/products/3049990>

Connection in acc. with standard	DIN 46237:1970-07
Cross section	1 mm ² ... 6 mm ²
Cross section range AWG	16 ... 10 (converted acc. to IEC)
Hole diameter	5.3 mm
Width	10 mm
Bolt diameter	5 mm
Screw thread	M5
Tightening torque	2.5 ... 3 Nm
Identification color of ring cable lugs : red	1 mm ²
Identification color of ring cable lugs : blue	2.5 mm ²
Identification color of ring cable lugs : yellow	6 mm ²

Dimensions

Width	16.3 mm
End cover width	2.2 mm
Height	91.4 mm
Depth on NS 35/7,5	51 mm
Depth on NS 35/15	58.5 mm

Material specifications

Color	gray
Flammability rating according to UL 94	V0
Insulating material group	I
Insulating material	PA
Static insulating material application in cold	-60 °C
Temperature index of insulation material (DIN EN 60216-1 (VDE 0304-21))	130 °C
Relative insulation material temperature index (Elec., UL 746 B)	130 °C
Fire protection for rail vehicles (DIN EN 45545-2) R22	HL 1 - HL 3
Fire protection for rail vehicles (DIN EN 45545-2) R23	HL 1 - HL 3
Fire protection for rail vehicles (DIN EN 45545-2) R24	HL 1 - HL 3
Fire protection for rail vehicles (DIN EN 45545-2) R26	HL 1 - HL 3
Calorimetric heat release NFPA 130 (ASTM E 1354)	28 MJ/kg
Surface flammability NFPA 130 (ASTM E 162)	passed
Specific optical density of smoke NFPA 130 (ASTM E 662)	passed
Smoke gas toxicity NFPA 130 (SMP 800C)	passed

Electrical tests

Surge voltage test

Result	Test passed
--------	-------------

Temperature-rise test

Requirement temperature-rise test	Increase in temperature ≤ 45 K
Result	Test passed

RTO 5-T-TC - Test disconnect terminal block



3049990

<https://www.phoenixcontact.com/us/products/3049990>

Short-time withstand current 6 mm ²	0.72 kA
Result	Test passed

Power-frequency withstand voltage

Test voltage setpoint	2.2 kV
Result	Test passed

Mechanical properties

Mechanical data

Open side panel	Yes
-----------------	-----

Mechanical tests

Mechanical strength

Result	Test passed
--------	-------------

Environmental and real-life conditions

Needle-flame test

Time of exposure	30 s
Result	Test passed

Oscillation/broadband noise

Specification	DIN EN 50155 (VDE 0115-200):2018-05
Spectrum	Service life test category 2, bogie-mounted
Frequency	$f_1 = 5 \text{ Hz}$ to $f_2 = 250 \text{ Hz}$
ASD level	6.12 (m/s ²) ² /Hz
Acceleration	3.12g
Test duration per axis	5 h
Test directions	X-, Y- and Z-axis

Shocks

Specification	DIN EN 50155 (VDE 0115-200):2008-03
Pulse shape	Half-sine
Acceleration	30g
Shock duration	18 ms
Number of shocks per direction	3
Test directions	X-, Y- and Z-axis (pos. and neg.)

Ambient conditions

Ambient temperature (operation)	-60 °C ... 110 °C (Operating temperature range incl. self-heating; for max. short-term operating temperature, see RTI Elec.)
Ambient temperature (storage/transport)	-25 °C ... 60 °C (for a short time, not exceeding 24 h, -60 °C to +70 °C)
Ambient temperature (assembly)	-5 °C ... 70 °C
Ambient temperature (actuation)	-5 °C ... 70 °C
Permissible humidity (operation)	20 % ... 90 %

RTO 5-T-TC - Test disconnect terminal block



3049990

<https://www.phoenixcontact.com/us/products/3049990>

Permissible humidity (storage/transport)	30 % ... 70 %
--	---------------

Standards and regulations

Connection in acc. with standard	IEC 60947-7-1
----------------------------------	---------------

Mounting

Mounting type	NS 35/7,5
	NS 35/15

RTO 5-T-TC - Test disconnect terminal block

3049990

<https://www.phoenixcontact.com/us/products/3049990>

Drawings

Connection diagram

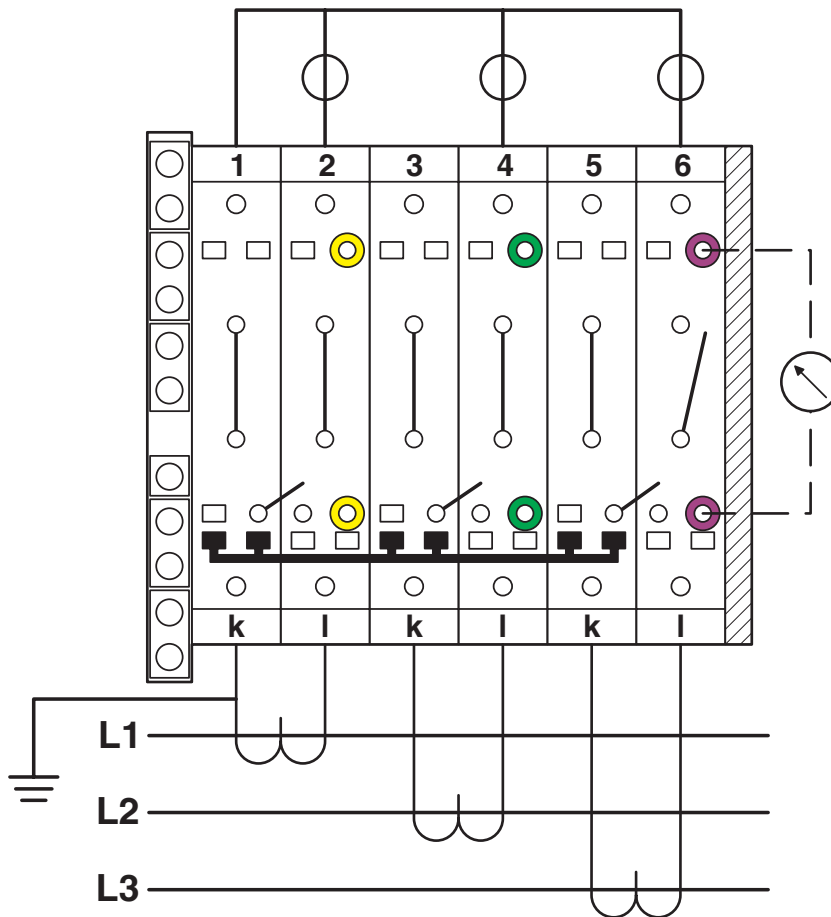

Three-phase transducer test set

RTO 5-T-TC - Test disconnect terminal block



3049990

<https://www.phoenixcontact.com/us/products/3049990>

Circuit diagram

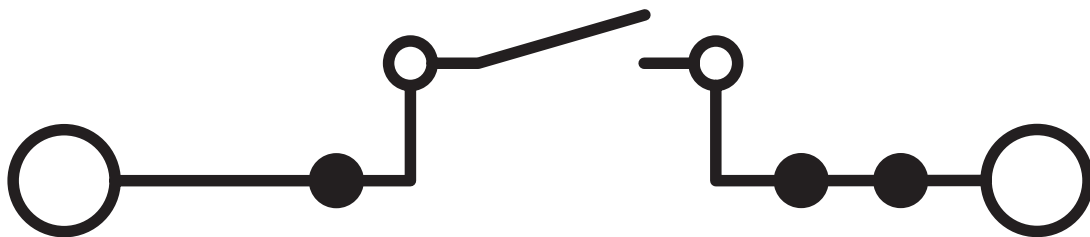

RTO 5-T-TC - Test disconnect terminal block

3049990

<https://www.phoenixcontact.com/us/products/3049990>



Connection diagram

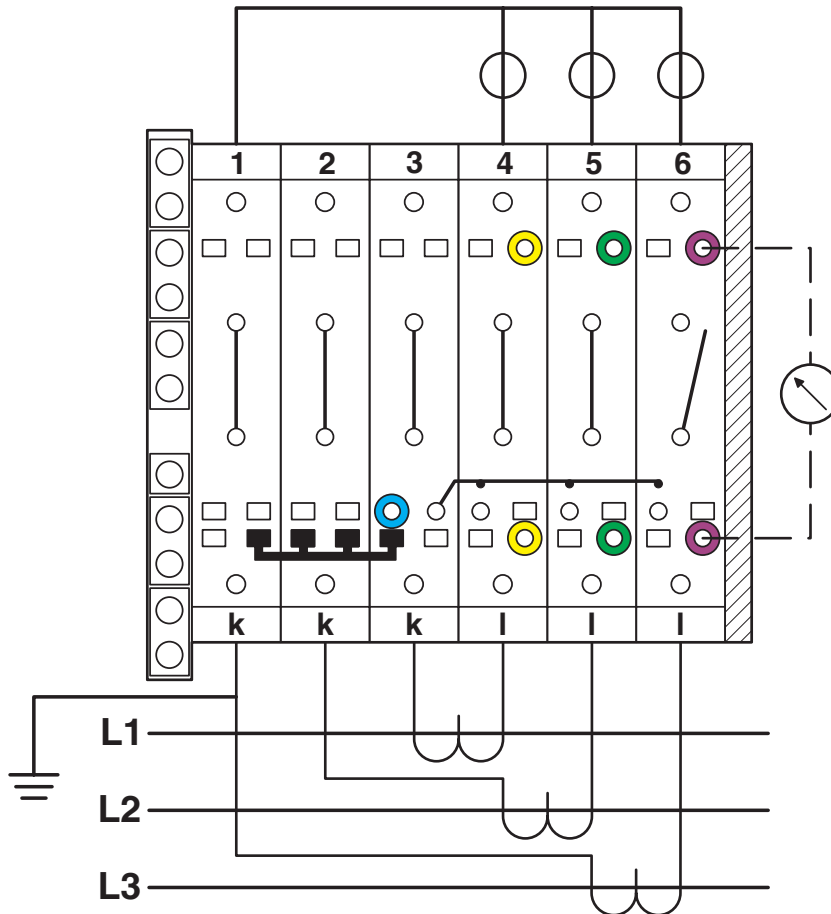

Three-phase linked transducer test set

RTO 5-T-TC - Test disconnect terminal block

3049990

<https://www.phoenixcontact.com/us/products/3049990>

Connection diagram

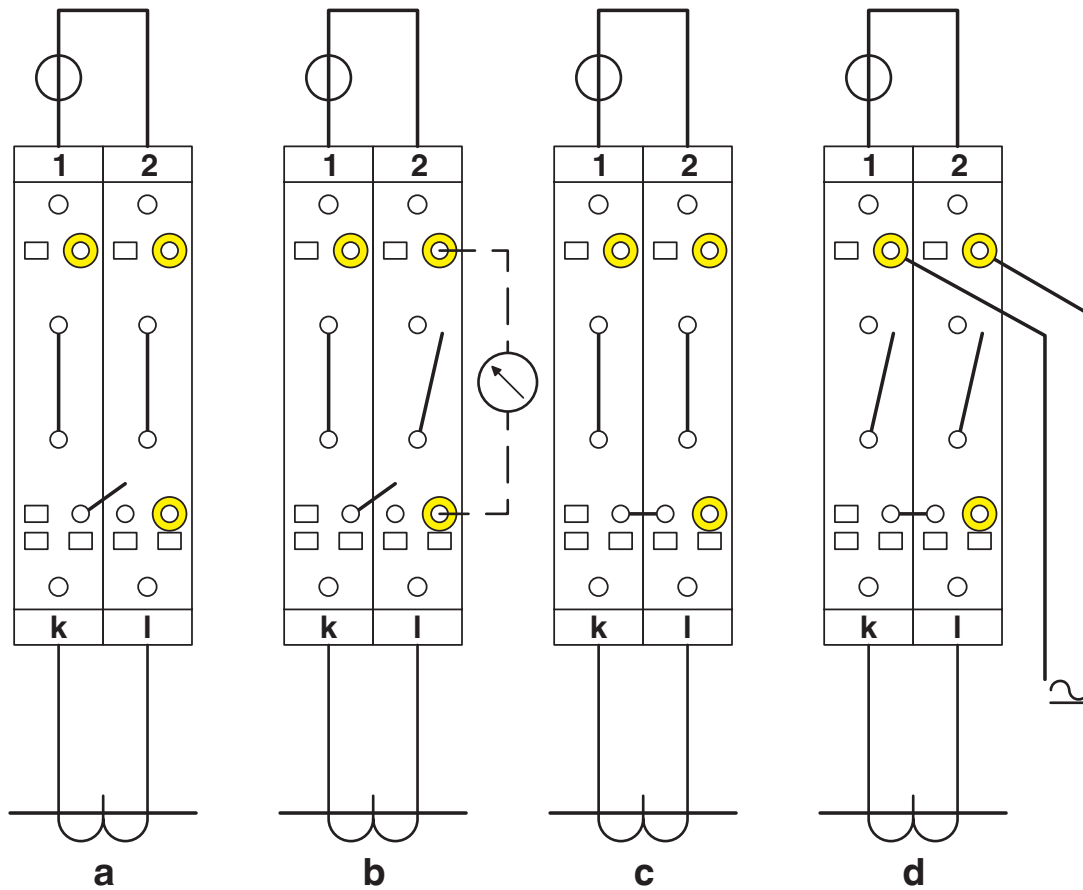

Simple current transformer test circuit

a = normal operation

b = measured value testing

c = transformer testing

d = relay testing

RTO 5-T-TC - Test disconnect terminal block



3049990

<https://www.phoenixcontact.com/us/products/3049990>

Approvals

To download certificates, visit the product detail page: <https://www.phoenixcontact.com/us/products/3049990>



EAC

Approval ID: RU C-DE.A*30.B.01742



cULus Recognized

Approval ID: E60425

	Nominal voltage U_N	Nominal current I_N	Cross section AWG	Cross section mm^2
Use group B	600 V	30 A	NA - NA	-
Use group C	600 V	30 A	NA - NA	-



EAC

Approval ID: RU C-DE.BL08.B.00540

RTO 5-T-TC - Test disconnect terminal block



3049990

<https://www.phoenixcontact.com/us/products/3049990>

Classifications

ECLASS

ECLASS-11.0	27141126
ECLASS-12.0	27141126
ECLASS-13.0	27250101

ETIM

ETIM 9.0	EC000902
----------	----------

UNSPSC

UNSPSC 21.0	39121400
-------------	----------

RTO 5-T-TC - Test disconnect terminal block



3049990

<https://www.phoenixcontact.com/us/products/3049990>

Environmental product compliance

EU RoHS

Fulfills EU RoHS substance requirements	Yes, No exemptions
---	--------------------

China RoHS

Environment friendly use period (EFUP)	EFUP-E
	No hazardous substances above the limits

EU REACH SVHC

REACH candidate substance (CAS No.)	No substance above 0.1 wt%
-------------------------------------	----------------------------

RTO 5-T-TC - Test disconnect terminal block

3049990

<https://www.phoenixcontact.com/us/products/3049990>

Accessories

 Note: Applying some accessories below might limit this product.

FBS 2-8 - Plug-in bridge

3030284

<https://www.phoenixcontact.com/us/products/3030284>



Plug-in bridge, pitch: 8.2 mm, number of positions: 2, color: red

 Max. current carrying capacity: 41 A

FBS 3-8 - Plug-in bridge

3030297

<https://www.phoenixcontact.com/us/products/3030297>



Plug-in bridge, pitch: 8.2 mm, number of positions: 3, color: red

 Max. current carrying capacity: 41 A

RTO 5-T-TC - Test disconnect terminal block

3049990

<https://www.phoenixcontact.com/us/products/3049990>



FBS 4-8 - Plug-in bridge

3030307

<https://www.phoenixcontact.com/us/products/3030307>



Plug-in bridge, pitch: 8.2 mm, number of positions: 4, color: red

 Max. current carrying capacity: 41 A

FBS 5-8 - Plug-in bridge

3030310

<https://www.phoenixcontact.com/us/products/3030310>



Plug-in bridge, pitch: 8.2 mm, number of positions: 5, color: red

 Max. current carrying capacity: 41 A

RTO 5-T-TC - Test disconnect terminal block

3049990

<https://www.phoenixcontact.com/us/products/3049990>



FBS 10-8 - Plug-in bridge

3030323

<https://www.phoenixcontact.com/us/products/3030323>



Plug-in bridge, pitch: 8.2 mm, number of positions: 10, color: red

 Max. current carrying capacity: 41 A

FBSR 2-8 - Plug-in bridge

3033808

<https://www.phoenixcontact.com/us/products/3033808>



Plug-in bridge, pitch: 8.2 mm, number of positions: 2, color: red

 Max. current carrying capacity: 32 A

RTO 5-T-TC - Test disconnect terminal block

3049990

<https://www.phoenixcontact.com/us/products/3049990>



FBSR 3-8 - Plug-in bridge

3001597

<https://www.phoenixcontact.com/us/products/3001597>



Plug-in bridge, pitch: 8.2 mm, number of positions: 3, color: red

 Max. current carrying capacity: 32 A

FBSR 4-8 - Plug-in bridge

3000585

<https://www.phoenixcontact.com/us/products/3000585>



Plug-in bridge, pitch: 8.2 mm, number of positions: 4, color: red

 Max. current carrying capacity: 32 A

RTO 5-T-TC - Test disconnect terminal block

3049990

<https://www.phoenixcontact.com/us/products/3049990>

FBSR 5-8 - Plug-in bridge

3033809

<https://www.phoenixcontact.com/us/products/3033809>



Plug-in bridge, pitch: 8.2 mm, number of positions: 5, color: red

 Max. current carrying capacity: 32 A

FBSR 10-8 - Plug-in bridge

3001599

<https://www.phoenixcontact.com/us/products/3001599>



Plug-in bridge, pitch: 8.2 mm, number of positions: 10, color: red

 Max. current carrying capacity: 32 A

RTO 5-T-TC - Test disconnect terminal block



3049990

<https://www.phoenixcontact.com/us/products/3049990>

FBSRH 2-8 - Short-circuit connector

3033802

<https://www.phoenixcontact.com/us/products/3033802>



Short-circuit connector, pitch: 8.2 mm, number of positions: 2, color: red

 Max. current carrying capacity: 32 A

FBSRH 3-8 - Short-circuit connector

3033803

<https://www.phoenixcontact.com/us/products/3033803>



Short-circuit connector, pitch: 8.2 mm, number of positions: 3, color: red

 Max. current carrying capacity: 32 A

RTO 5-T-TC - Test disconnect terminal block

3049990

<https://www.phoenixcontact.com/us/products/3049990>



FBSRH 4-8 - Short-circuit connector

3033804

<https://www.phoenixcontact.com/us/products/3033804>



Short-circuit connector, pitch: 8.2 mm, number of positions: 4, color: red

 Max. current carrying capacity: 32 A

FBS 2-8 CT - Plug-in bridge

3033830

<https://www.phoenixcontact.com/us/products/3033830>



Plug-in bridge, pitch: 8.2 mm, number of positions: 2, color: orange

 Max. current carrying capacity: 41 A

RTO 5-T-TC - Test disconnect terminal block

3049990

<https://www.phoenixcontact.com/us/products/3049990>



FBS 3-8 CT - Plug-in bridge

3033831

<https://www.phoenixcontact.com/us/products/3033831>



Plug-in bridge, pitch: 8.2 mm, number of positions: 3, color: orange

 Max. current carrying capacity: 41 A

FBS 4-8 CT - Plug-in bridge

3033832

<https://www.phoenixcontact.com/us/products/3033832>



Plug-in bridge, pitch: 8.2 mm, number of positions: 4, color: orange

 Max. current carrying capacity: 41 A

RTO 5-T-TC - Test disconnect terminal block

3049990

<https://www.phoenixcontact.com/us/products/3049990>



FBS 10-8 CT - Plug-in bridge

3033833

<https://www.phoenixcontact.com/us/products/3033833>



Plug-in bridge, pitch: 8.2 mm, number of positions: 10, color: orange

 Max. current carrying capacity: 41 A

FBS 2-8 BU - Plug-in bridge

3032567

<https://www.phoenixcontact.com/us/products/3032567>



Plug-in bridge, pitch: 8.2 mm, number of positions: 2, color: blue

 Max. current carrying capacity: 41 A

RTO 5-T-TC - Test disconnect terminal block

3049990

<https://www.phoenixcontact.com/us/products/3049990>



FBS 3-8 BU - Plug-in bridge

3032570

<https://www.phoenixcontact.com/us/products/3032570>



Plug-in bridge, pitch: 8.2 mm, number of positions: 3, color: blue

 Max. current carrying capacity: 41 A

FBS 4-8 BU - Plug-in bridge

3032583

<https://www.phoenixcontact.com/us/products/3032583>



Plug-in bridge, pitch: 8.2 mm, number of positions: 4, color: blue

 Max. current carrying capacity: 41 A

RTO 5-T-TC - Test disconnect terminal block

3049990

<https://www.phoenixcontact.com/us/products/3049990>

FBS 5-8 BU - Plug-in bridge

3032596

<https://www.phoenixcontact.com/us/products/3032596>



Plug-in bridge, pitch: 8.2 mm, number of positions: 5, color: blue

 Max. current carrying capacity: 41 A

FBS 6-8 BU - Plug-in bridge

3032677

<https://www.phoenixcontact.com/us/products/3032677>



Plug-in bridge, pitch: 8.2 mm, number of positions: 6, color: blue

 Max. current carrying capacity: 41 A

RTO 5-T-TC - Test disconnect terminal block

3049990

<https://www.phoenixcontact.com/us/products/3049990>

FBS 10-8 BU - Plug-in bridge

3032606

<https://www.phoenixcontact.com/us/products/3032606>



Plug-in bridge, pitch: 8.2 mm, number of positions: 10, color: blue

 Max. current carrying capacity: 41 A

SB-MER 2-8 - Switching jumper

3000587

<https://www.phoenixcontact.com/us/products/3000587>



Switching jumper, pitch: 8.2 mm, number of positions: 2, length: 25 mm, color: gray/orange

 Max. current carrying capacity: 25 A

RTO 5-T-TC - Test disconnect terminal block

3049990

<https://www.phoenixcontact.com/us/products/3049990>

RB UT 6-ST(2,5/4) - Reducing bridge

3047264

<https://www.phoenixcontact.com/us/products/3047264>



Reducing bridge, pitch: 9.5 mm, number of positions: 2, length: 33 mm, color: red

 Max. current carrying capacity: 35 A

RB UT 6-(2,5/4) - Reducing bridge

3047251

<https://www.phoenixcontact.com/us/products/3047251>



Reducing bridge, pitch: 9.5 mm, number of positions: 2, length: 25 mm, color: red

 Max. current carrying capacity: 40 A

RTO 5-T-TC - Test disconnect terminal block



3049990

<https://www.phoenixcontact.com/us/products/3049990>

D-RT 5-T - End cover

3049291

<https://www.phoenixcontact.com/us/products/3049291>

End cover, depth: 42.2 mm, width: 2.2 mm, height: 90.4 mm, color: gray



TPNS-UK - Partition plate

0706647

<https://www.phoenixcontact.com/us/products/0706647>

Partition plate, depth: 70 mm, width: 2 mm, height: 80 mm, color: gray



RTO 5-T-TC - Test disconnect terminal block

3049990

<https://www.phoenixcontact.com/us/products/3049990>



BE-RT 3/5 - Path extension

3049819

<https://www.phoenixcontact.com/us/products/3049819>



Path extension, color: gray

S-RT 5-T - Switching lock

3049330

<https://www.phoenixcontact.com/us/products/3049330>



Switching lock, depth: 26.5 mm, width: 8.3 mm, height: 15.65 mm, color: white

RTO 5-T-TC - Test disconnect terminal block



3049990

<https://www.phoenixcontact.com/us/products/3049990>

LPS-8/E - Service connector

3270560

<https://www.phoenixcontact.com/us/products/3270560>



Service connector, nom. voltage: 800 V, nominal current: 24 A, number of positions: 1, connection method: Push-in connection, Rated cross section: 2.5 mm², cross section: 0.14 mm²- 4 mm², color: red

LPS-8 - Service connector

3270561

<https://www.phoenixcontact.com/us/products/3270561>



Service connector, nom. voltage: 800 V, nominal current: 24 A, number of positions: 1, connection method: Push-in connection, Rated cross section: 2.5 mm², cross section: 0.14 mm²- 4 mm², color: red

RTO 5-T-TC - Test disconnect terminal block

3049990

<https://www.phoenixcontact.com/us/products/3049990>

LPO 6/E - Pick-off plug

3270525

<https://www.phoenixcontact.com/us/products/3270525>



Pick-off plug, nom. voltage: 800 V, nominal current: 24 A, number of positions: 1, connection method: Push-in connection, Rated cross section: 2.5 mm², cross section: 0.14 mm²- 4 mm², color: gray

LPO 6 - Pick-off plug

3270526

<https://www.phoenixcontact.com/us/products/3270526>



Pick-off plug, nom. voltage: 800 V, nominal current: 24 A, number of positions: 1, connection method: Push-in connection, Rated cross section: 2.5 mm², cross section: 0.14 mm²- 4 mm², color: gray

RTO 5-T-TC - Test disconnect terminal block



3049990

<https://www.phoenixcontact.com/us/products/3049990>

NS 35/ 7,5 PERF 2000MM - DIN rail perforated

0801733

<https://www.phoenixcontact.com/us/products/0801733>



DIN rail perforated, Pack of 25 (50 m), acc. to EN 60715, material: Steel, galvanized, passivated with a thick layer, Standard profile, color: silver

NS 35/ 7,5 UNPERF 2000MM - DIN rail, unperforated

0801681

<https://www.phoenixcontact.com/us/products/0801681>



DIN rail, unperforated, Pack of 25 (50 m), acc. to EN 60715, material: Steel, galvanized, passivated with a thick layer, Standard profile, color: silver

RTO 5-T-TC - Test disconnect terminal block



3049990

<https://www.phoenixcontact.com/us/products/3049990>

NS 35/ 7,5 WH PERF 2000MM - DIN rail perforated

1204119

<https://www.phoenixcontact.com/us/products/1204119>



DIN rail perforated, Pack of 25 (50 m), acc. to EN 60715, material: Steel, Galvanized, white passivated, Standard profile, color: silver

NS 35/ 7,5 WH UNPERF 2000MM-VPE 10 - DIN rail, unperforated

1204122

<https://www.phoenixcontact.com/us/products/1204122>



DIN rail, unperforated, Pack of 10 (20 m), acc. to EN 60715, material: Steel, Galvanized, white passivated, Standard profile, color: silver

RTO 5-T-TC - Test disconnect terminal block



3049990

<https://www.phoenixcontact.com/us/products/3049990>

NS 35/ 7,5 AL UNPERF 2000MM - DIN rail, unperforated

0801704

<https://www.phoenixcontact.com/us/products/0801704>



DIN rail, unperforated, Pack of 25 (50 m), acc. to EN 60715, material: Aluminum, uncoated, Standard profile, color: silver

NS 35/ 7,5 ZN PERF 2000MM - DIN rail perforated

1206421

<https://www.phoenixcontact.com/us/products/1206421>



DIN rail perforated, Pack of 25 (50 m), acc. to EN 60715, material: Steel, galvanized, Standard profile, color: silver

RTO 5-T-TC - Test disconnect terminal block



3049990

<https://www.phoenixcontact.com/us/products/3049990>

NS 35/ 7,5 ZN UNPERF 2000MM - DIN rail, unperforated

1206434

<https://www.phoenixcontact.com/us/products/1206434>



DIN rail, unperforated, Pack of 25 (50 m), acc. to EN 60715, material: Steel, galvanized, Standard profile, color: silver

NS 35/ 7,5 CU UNPERF 2000MM-VPE 10 - DIN rail, unperforated

0801762

<https://www.phoenixcontact.com/us/products/0801762>



DIN rail, unperforated, Pack of 10 (20 m), acc. to EN 60715, material: Copper, uncoated, Standard profile, color: copper-colored

RTO 5-T-TC - Test disconnect terminal block

3049990

<https://www.phoenixcontact.com/us/products/3049990>



NS 35/ 7,5 CAP - End cap

1206560

<https://www.phoenixcontact.com/us/products/1206560>

DIN rail end piece, for DIN rail NS 35/7.5



NS 35/15 PERF 2000MM - DIN rail perforated

1201730

<https://www.phoenixcontact.com/us/products/1201730>



DIN rail perforated, Pack of 25 (50 m), similar to EN 60715, material: Steel, galvanized, passivated with a thick layer, Standard profile, color: silver

RTO 5-T-TC - Test disconnect terminal block

3049990

<https://www.phoenixcontact.com/us/products/3049990>

NS 35/15 UNPERF 2000MM - DIN rail, unperforated

1201714

<https://www.phoenixcontact.com/us/products/1201714>



DIN rail, unperforated, Pack of 25 (50 m), similar to EN 60715, material: Steel, galvanized, passivated with a thick layer, Standard profile, color: silver

NS 35/15 WH PERF 2000MM - DIN rail perforated

0806602

<https://www.phoenixcontact.com/us/products/0806602>



DIN rail perforated, Pack of 25 (50 m), similar to EN 60715, material: Steel, Galvanized, white passivated, Standard profile, color: white

RTO 5-T-TC - Test disconnect terminal block



3049990

<https://www.phoenixcontact.com/us/products/3049990>

NS 35/15 WH UNPERF 2000MM-VPE 10 - DIN rail, unperforated

1204135

<https://www.phoenixcontact.com/us/products/1204135>



DIN rail, unperforated, Pack of 10 (20 m), similar to EN 60715, material: Steel, Galvanized, white passivated, Standard profile, color: silver

NS 35/15 AL UNPERF 2000MM - DIN rail, unperforated

1201756

<https://www.phoenixcontact.com/us/products/1201756>



DIN rail, unperforated, similar to EN 60715, material: Aluminum, uncoated, Standard profile, color: silver

RTO 5-T-TC - Test disconnect terminal block



3049990

<https://www.phoenixcontact.com/us/products/3049990>

NS 35/15 ZN PERF 2000MM - DIN rail perforated

1206599

<https://www.phoenixcontact.com/us/products/1206599>



DIN rail perforated, Pack of 25 (50 m), similar to EN 60715, material: Steel, galvanized, Standard profile, color: silver

NS 35/15 ZN UNPERF 2000MM - DIN rail, unperforated

1206586

<https://www.phoenixcontact.com/us/products/1206586>



DIN rail, unperforated, Pack of 25 (50 m), similar to EN 60715, material: Steel, galvanized, Standard profile, color: silver

RTO 5-T-TC - Test disconnect terminal block



3049990

<https://www.phoenixcontact.com/us/products/3049990>

NS 35/15 CU UNPERF 2000MM-VPE 10 - DIN rail, unperforated

1201895

<https://www.phoenixcontact.com/us/products/1201895>



DIN rail, unperforated, Pack of 10 (20 m), similar to EN 60715, material: Copper, uncoated, Standard profile, color: copper-colored

NS 35/15 CAP - End cap

1206573

<https://www.phoenixcontact.com/us/products/1206573>

DIN rail end piece, for DIN rail NS 35/15



RTO 5-T-TC - Test disconnect terminal block

3049990

<https://www.phoenixcontact.com/us/products/3049990>



NS 35/15-2,3 UNPERF 2000MM-VPE 10 - DIN rail, unperforated

1201798

<https://www.phoenixcontact.com/us/products/1201798>



DIN rail, unperforated, Pack of 10 (20 m), acc. to EN 60715, material: Steel, galvanized, passivated with a thick layer, Standard profile 2.3 mm, color: silver

ZB 16:UNPRINTED - Zack marker strip

0827461

<https://www.phoenixcontact.com/us/products/0827461>



Zack marker strip, Strip, white, unlabeled, can be labeled with: PLOTMARK, CMS-P1-PLOTTER, mounting type: snapped, for terminal block width: 16 mm, lettering field size: 16 x 10.5 mm, Number of individual labels: 50

RTO 5-T-TC - Test disconnect terminal block



3049990

<https://www.phoenixcontact.com/us/products/3049990>

ZB 16 CUS - Zack marker strip

0827463

<https://www.phoenixcontact.com/us/products/0827463>



Zack marker strip, can be ordered: Strip, white, labeled according to customer specifications, mounting type: snap into tall marker groove, for terminal block width: 16 mm, lettering field size: 10.5 x 16 mm, Number of individual labels: 5

ZB 16,LGS:L1-N,PE - Zack marker strip

0827462

<https://www.phoenixcontact.com/us/products/0827462>



Zack marker strip, Strip, white, labeled, printed horizontally: L1, L2, L3, N, PE, mounting type: snapped, for terminal block width: 16.3 mm, lettering field size: 10.5 x 16.25 mm, Number of individual labels: 5

RTO 5-T-TC - Test disconnect terminal block



3049990

<https://www.phoenixcontact.com/us/products/3049990>

UC-TM 16 - Marker for terminal blocks

0819217

<https://www.phoenixcontact.com/us/products/0819217>



Marker for terminal blocks, Sheet, white, unlabeled, can be labeled with: BLUEMARK ID COLOR, BLUEMARK ID, BLUEMARK CLED, PLOTMARK, CMS-P1-PLOTTER, mounting type: snapped, for terminal block width: 16 mm, lettering field size: 15.45 x 10.5 mm, Number of individual labels: 32

UC-TM 16 CUS - Marker for terminal blocks

0824621

<https://www.phoenixcontact.com/us/products/0824621>



Marker for terminal blocks, can be ordered: by sheet, white, labeled according to customer specifications, mounting type: snap into tall marker groove, for terminal block width: 16 mm, lettering field size: 15.45 x 10.5 mm, Number of individual labels: 32

RTO 5-T-TC - Test disconnect terminal block



3049990

<https://www.phoenixcontact.com/us/products/3049990>

UCT-TM 16 - Marker for terminal blocks

0829146

<https://www.phoenixcontact.com/us/products/0829146>



Marker for terminal blocks, Sheet, white, unlabeled, can be labeled with: TOPMARK NEO, TOPMARK LASER, BLUEMARK ID COLOR, BLUEMARK ID, BLUEMARK CLED, THERMOMARK PRIME, THERMOMARK CARD 2.0, THERMOMARK CARD, mounting type: snapped, for terminal block width: 16 mm, lettering field size: 14.8 x 9.6 mm, Number of individual labels: 18

UCT-TM 16 CUS - Marker for terminal blocks

0829637

<https://www.phoenixcontact.com/us/products/0829637>



Marker for terminal blocks, can be ordered: by sheet, white, labeled according to customer specifications, mounting type: snap into tall marker groove, for terminal block width: 16 mm, lettering field size: 14.8 x 9.6 mm, Number of individual labels: 18

RTO 5-T-TC - Test disconnect terminal block



3049990

<https://www.phoenixcontact.com/us/products/3049990>

ZB 16,3:UNPRINTED - Zack marker strip

0820222

<https://www.phoenixcontact.com/us/products/0820222>



Zack marker strip, Strip, white, unlabeled, can be labeled with: PLOTMARK, CMS-P1-PLOTTER, mounting type: snapped, for terminal block width: 16.3 mm, lettering field size: 10.5 x 16.25 mm, Number of individual labels: 5

ZB 16,3 CUS - Zack marker strip

0824946

<https://www.phoenixcontact.com/us/products/0824946>



Zack marker strip, can be ordered: Strip, white, labeled according to customer specifications, mounting type: snap into tall marker groove, for terminal block width: 16.3 mm, lettering field size: 10.5 x 16.25 mm, Number of individual labels: 5

RTO 5-T-TC - Test disconnect terminal block

3049990

<https://www.phoenixcontact.com/us/products/3049990>



MPS-MT - Test plug

0201744

<https://www.phoenixcontact.com/us/products/0201744>



Test plug, with solder connection up to 1 mm² conductor cross section, number of positions: 1, color: gray

MPS-IH WH - Insulating sleeve

0201663

<https://www.phoenixcontact.com/us/products/0201663>

Insulating sleeve, color: white



RTO 5-T-TC - Test disconnect terminal block

3049990

<https://www.phoenixcontact.com/us/products/3049990>



MPS-IH RD - Insulating sleeve

0201676

<https://www.phoenixcontact.com/us/products/0201676>

Insulating sleeve, color: red



MPS-IH BU - Insulating sleeve

0201689

<https://www.phoenixcontact.com/us/products/0201689>

Insulating sleeve, color: blue

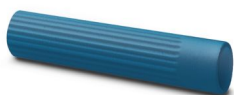

RTO 5-T-TC - Test disconnect terminal block



3049990

<https://www.phoenixcontact.com/us/products/3049990>

MPS-IH YE - Insulating sleeve

0201692

<https://www.phoenixcontact.com/us/products/0201692>

Insulating sleeve, color: yellow



MPS-IH GN - Insulating sleeve

0201702

<https://www.phoenixcontact.com/us/products/0201702>

Insulating sleeve, color: green



RTO 5-T-TC - Test disconnect terminal block

3049990

<https://www.phoenixcontact.com/us/products/3049990>



MPS-IH GY - Insulating sleeve

0201728

<https://www.phoenixcontact.com/us/products/0201728>

Insulating sleeve, color: gray



MPS-IH BK - Insulating sleeve

0201731

<https://www.phoenixcontact.com/us/products/0201731>

Insulating sleeve, color: black



RTO 5-T-TC - Test disconnect terminal block

3049990

<https://www.phoenixcontact.com/us/products/3049990>



PAI-4-N GY - Test adapter

3032871

<https://www.phoenixcontact.com/us/products/3032871>



4 mm test adapter, for terminal blocks with 5.2 mm, 6.2 mm and 8.2 mm pitch

PS-8 - Test plug

3031005

<https://www.phoenixcontact.com/us/products/3031005>



Test plug, Modular test plug, number of positions: 1, color: red

RTO 5-T-TC - Test disconnect terminal block



3049990

<https://www.phoenixcontact.com/us/products/3049990>

DP PS-8 - Spacer plate

3036741

<https://www.phoenixcontact.com/us/products/3036741>



Spacer plate, depth: 29 mm, width: 8.2 mm, height: 22.4 mm, number of positions: 1, color: red

PS-8/2,3MM RD - Test plug

3048564

<https://www.phoenixcontact.com/us/products/3048564>



Test plug, number of positions: 1, color: red

RTO 5-T-TC - Test disconnect terminal block

3049990

<https://www.phoenixcontact.com/us/products/3049990>

CLIPFIX 35 - End bracket

3022218

<https://www.phoenixcontact.com/us/products/3022218>



Quick mounting end clamp for NS 35/7,5 DIN rail or NS 35/15 DIN rail, with marking option, width: 9.5 mm, color: gray

CLIPFIX 35-5 - End bracket

3022276

<https://www.phoenixcontact.com/us/products/3022276>



Quick mounting end clamp for NS 35/7,5 DIN rail or NS 35/15 DIN rail, with marking option, with parking option for FBS...5, FBS...6, KSS 5, KSS 6, width: 5.15 mm, color: gray

RTO 5-T-TC - Test disconnect terminal block

3049990

<https://www.phoenixcontact.com/us/products/3049990>

E/NS 35 N - End bracket

0800886

<https://www.phoenixcontact.com/us/products/0800886>

End clamp, width: 9.5 mm, color: gray

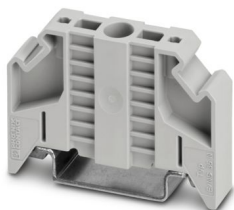

E/UK - End bracket

1201442

<https://www.phoenixcontact.com/us/products/1201442>

End bracket, Mounting on a DIN rail NS 32 or NS 35, material: PA, color: gray



RTO 5-T-TC - Test disconnect terminal block



3049990

<https://www.phoenixcontact.com/us/products/3049990>

E/UK 1 - End bracket

1201413

<https://www.phoenixcontact.com/us/products/1201413>



End clamps, for supporting the ends of double-level and three-level terminal blocks, width: 10 mm, color: gray

SHN 8 - Tool

1209868

<https://www.phoenixcontact.com/us/products/1209868>



Socket wrench, wrench size 8 mm

RTO 5-T-TC - Test disconnect terminal block

3049990

<https://www.phoenixcontact.com/us/products/3049990>



TS-UT 6-T/SP - Separating plate

3072821

<https://www.phoenixcontact.com/us/products/3072821>

Separating plate, depth: 67.5 mm, width: 1 mm, height: 105.2 mm, color: gray



Phoenix Contact 2024 © - all rights reserved

<https://www.phoenixcontact.com>

Phoenix Contact USA
586 Fulling Mill Road
Middletown, PA 17057, United States
(+717) 944-1300
info@phoenixcon.com