

104505-9 ✓ ACTIVE

AMPMODU | AMPMODU MTE

TE Internal #: 104505-9

Pin Contact, Tin, 300 VAC, 26 - 22 AWG Wire Size, .12 - .4 mm² Wire Size, 254 - 642 CMA Wire Size, Crimp, Phosphor Bronze, Signal, AMPMODU MTE

[View on TE.com >](#)



Connectors > Contacts > Connector Contacts

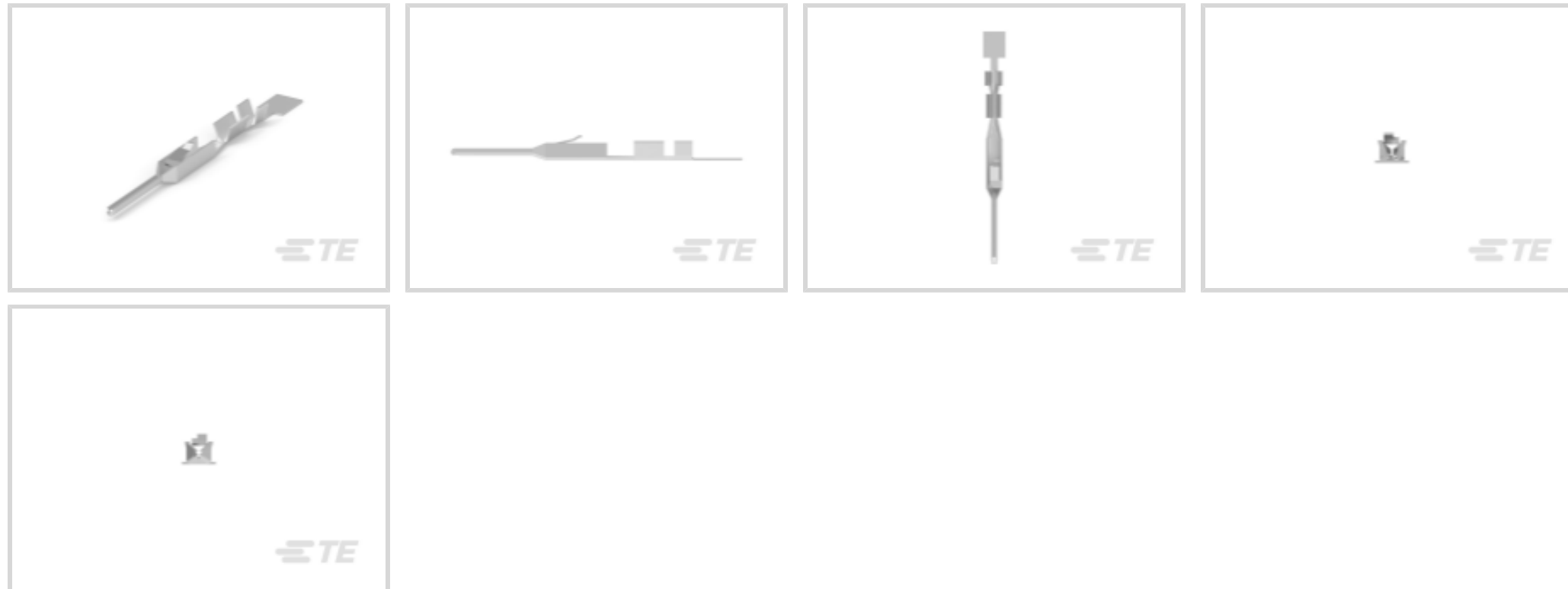

Contact Type: **Pin**

Contact Mating Area Plating Material: **Tin**

Wire Contact Termination Area Plating Material: **Tin**

Operating Voltage: **300 VAC**

Wire Size: **26 - 22 AWG**

Features

Product Type Features

Applied Pressure	Standard
------------------	----------

Electrical Characteristics

Termination Resistance	12 mΩ
Insulation Resistance	5000 MΩ
Dielectric Withstanding Voltage (Max)	750 V
Operating Voltage	300 VAC

Contact Features

Mating Square Post Dimension	.64 mm[.025 in]
Wire Contact Termination Area Plating Thickness	2.54 - 5.08 μm[100 - 200 μin]
Wire Contact Termination Area Plating Material Finish	Bright
	100 - 200 μin
Contact Mating Area Plating Material Finish	Bright
Contact Underplating Material	Nickel
Contact Type	Pin



Contact Mating Area Plating Material	Tin
Wire Contact Termination Area Plating Material	Tin
Contact Base Material	Phosphor Bronze
Contact Current Rating (Max)	3 A

Termination Features

Termination Method to Wire & Cable	Crimp
Product Terminates To	Wire & Cable

Mechanical Attachment

Wire Insulation Support	With
-------------------------	------

Dimensions

Compatible Insulation Diameter Range	.91 - 1.37 mm [.035 - .054 in]
Wire Size	254 - 642 CMA

Usage Conditions

Operating Temperature Range	-65 - 105 °C [-85 - 221 °F]
-----------------------------	-----------------------------

Operation/Application

Circuit Application	Signal
---------------------	--------

Industry Standards

Compatible With Approved Standards Products	CSA LR7189, UL E28476
---	-----------------------

Packaging Features

Packaging Quantity	500
Packaging Method	Loose Piece

Product Compliance

[For compliance documentation, visit the product page on TE.com>](#)

EU RoHS Directive 2011/65/EU	Compliant
EU ELV Directive 2000/53/EC	Compliant
China RoHS 2 Directive MIIT Order No 32, 2016	No Restricted Materials Above Threshold
EU REACH Regulation (EC) No. 1907/2006	Current ECHA Candidate List: JAN 2024 (240) Candidate List Declared Against: JAN 2024 (240) Does not contain REACH SVHC
Halogen Content	Low Halogen - Br, Cl, F, I < 900 ppm per homogenous material. Also BFR/CFR/PVC

Free

Solder Process Capability

Not applicable for solder process capability

Product Compliance Disclaimer

This information is provided based on reasonable inquiry of our suppliers and represents our current actual knowledge based on the information they provided. This information is subject to change. The part numbers that TE has identified as EU RoHS compliant have a maximum concentration of 0.1% by weight in homogenous materials for lead, hexavalent chromium, mercury, PBB, PBDE, DBP, BBP, DEHP, DIBP, and 0.01% for cadmium, or qualify for an exemption to these limits as defined in the Annexes of Directive 2011/65/EU (RoHS2). Finished electrical and electronic equipment products will be CE marked as required by Directive 2011/65/EU. Components may not be CE marked. Additionally, the part numbers that TE has identified as EU ELV compliant have a maximum concentration of 0.1% by weight in homogenous materials for lead, hexavalent chromium, and mercury, and 0.01% for cadmium, or qualify for an exemption to these limits as defined in the Annexes of Directive 2000/53/EC (ELV). Regarding the REACH Regulation, the information TE provides on SVHC in articles for this part number is based on the latest European Chemicals Agency (ECHA) 'Guidance on requirements for substances in articles' posted at this URL: <https://echa.europa.eu/guidance-documents/guidance-on-reach>

Compatible Parts



TE Part # 91531-1
CCII MTE AMPMODU MTE PIN REC
26-22 ASSY



TE Part # 843477-1
TOOL, EXTRACTION RESET

Also in the Series | AMPMODU MTE



Connector Caps & Covers(40)



Connector Contacts(32)



Connector Hardware(1)



Insertion & Extraction Tools(1)



PCB Headers & Receptacles(763)



Standard Rectangular Connectors(2)



Wire-to-Board Connector Assemblies & Housings(585)

Customers Also Bought

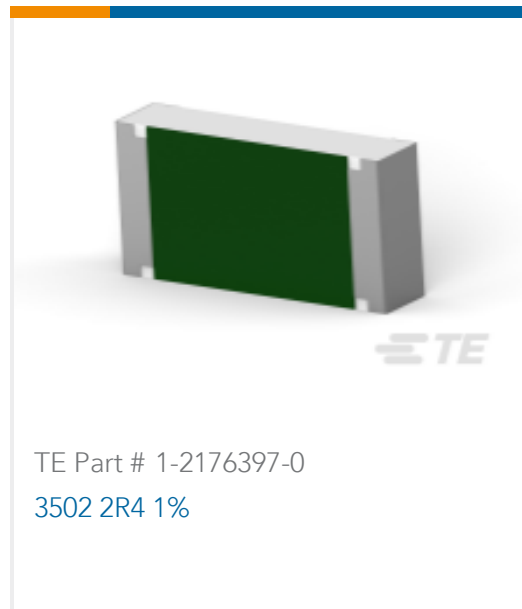
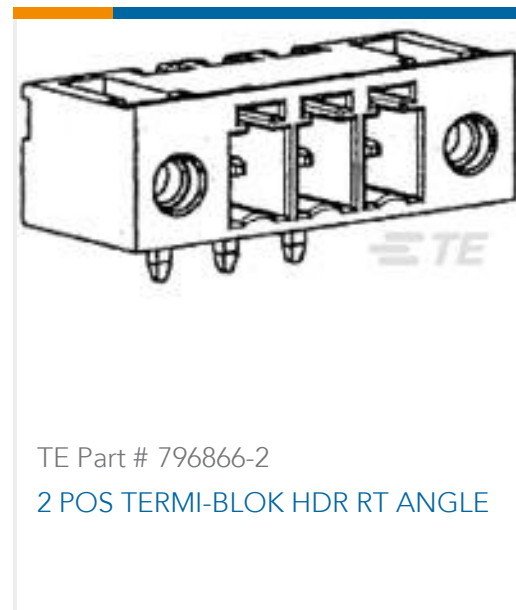

Documents

Product Drawings

MTE PIN LP

English

CAD Files

Customer View Model

[ENG_CVM_CVM_104505-9_V.2d_dxf.zip](#)

English

3D PDF

3D

Customer View Model

[ENG_CVM_CVM_104505-9_V.3d_igs.zip](#)

English

Customer View Model

[ENG_CVM_CVM_104505-9_V.3d_stp.zip](#)

English

By downloading the CAD file I accept and agree to the [Terms and Conditions](#) of use.

Datasheets & Catalog Pages

AMPMODU MTE INTERCONNECT SYSTEM

English

Product Specifications

Application Specification

English