

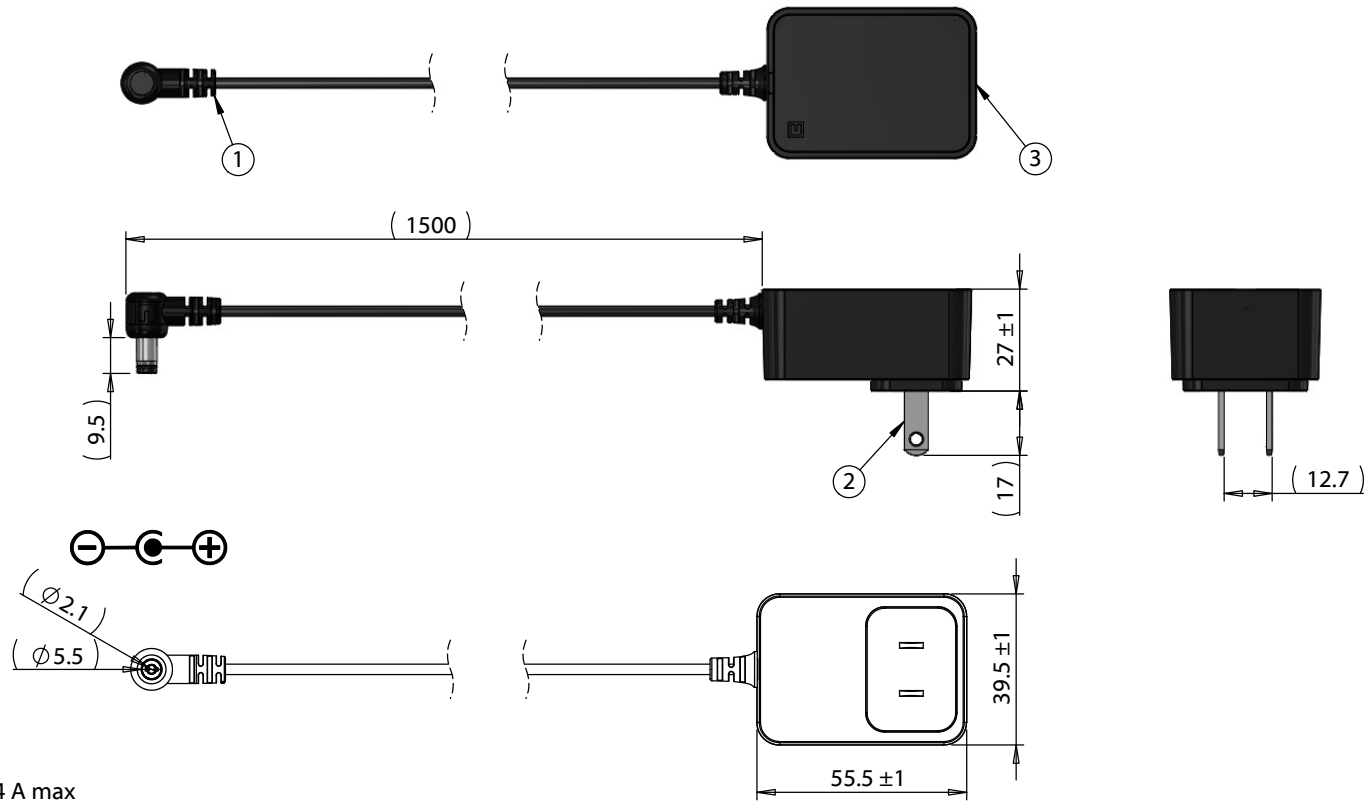



ITEM NO.	PART NUMBER	DESCRIPTION	QTY.	COMPONENT NOTES
1	10-03164	Cable, 1500 mm, 5.5x2.1x9.5 mm 50-00133 90° plug to stripped tinned, 22 AWG, 30-00341 wire	1	
2	Nema 1-15 plug	NEMA 1-15 plug, nickel plated	1	
3	26-00003	Case, wall mount, ac-dc power supply, 55.5x40x27 mm, NEMA 1-15	1	



Features:

- Wattage: 10 W, continuous
- Input voltage: 100 - 240 Vac, 50/60 Hz, 0.4 A max
- Output voltage: 5 Vdc
- Output current: 2 A
- Efficiency: DoE Level VI
- Safety: UL 62368-1

Revision:	Date:	Description:	Prepared:	Notes: RoHS compliant Approvals: 	 tel 1.541.323.3228 800 877.670.7118 fax 1.541.323.4202 web tensility.com		
A	03/14/2019	Initial release	Verified:				
			Dimensions are in millimeters. Tolerances: X: ± 0.5 mm X.X: ± 0.3 mm X.XX: ± 0.05 mm		Description: Adapter, WP, 120V, US, 2P, 5V 2000 mA, 5.5x2.1x9.5 mm 90° plug, 10-03164 cable, C+, Level VI	Size: A	Part number: 16-00066
					Scale: 1:2	 	Sheet 1 of 2

5

4

3

2

1

	Rating	Conditions
Input		
Input voltage	100 - 240 Vac	single phase
Frequency	50 - 60 Hz	
Steady ac current	0.4 A max	100 - 240 Vac
Inrush current	30 A max	240 Vac, cold start
Standby power	0.1 W max	115 or 230 Vac
Output		
No load output voltage	4.75 - 5.25 Vdc	
Full load output voltage	4.75 - 5.25 Vdc	2 A
Power	10 Watts continuous	all specified conditions
Ripple voltage	150 mV p-p at 2A	20 MHz bandwidth oscilloscope, terminated with 0.1 μ F ceramic capacitor and 10 μ F electrolytic capacitor, 25 °C
Over current protection	105 - 200% of max load	
Short circuit protection	input power shutdown, auto-recovery after fault removed	output short
Reliability & Safety		
Leakage current	0.25 mA max	nominal ac input voltage and frequency
Burn-in test	2 hours	45 °C max at normal input voltage and rated load
Efficiency	DoE Level VI, 78.7% min	115 or 230 Vac
MTBF	30,000 hours min	Telecordia SR-332
Hi-Pot (primary to secondary)	3300 Vac, 5 mA max	3 seconds (production testing)
Hi-Pot (primary to secondary)	3000 Vac, 10 mA max	60 seconds (safety testing)
Insulation resistance	100 M Ω , primary to secondary	500 Vdc
Safety testing	UL 62368-1	
Mechanical		
Weight	74 \pm 10 g	
Environmental		
Operating temperature	0 to 45 °C	10 - 90% relative humidity
Storage temperature	-25 to 70 °C	5 - 95% relative humidity

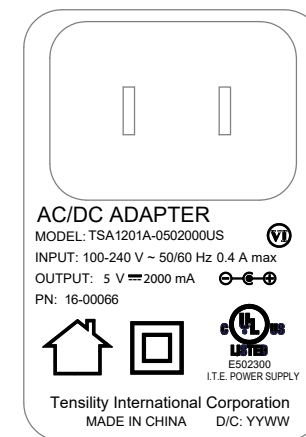

Not to Scale

Revision:	Date:	Description:	Prepared:	Notes:	TENSILITY
A	03/14/2019	Initial release	Verified:	RoHS compliant Approvals:	
			Dimensions are in millimeters. Tolerances:		tel 1.541.323.3228 800 877.670.7118 fax 1.541.323.4202 web tensility.com
			X: \pm 0.5 mm X.X: \pm 0.3 mm X.XX: \pm 0.05 mm	Description:	Size: Part number:
				Adapter, WP, 120V, US, 2P, 5V 2000 mA, 5.5x2.1x9.5 mm 90° plug, 10-03164 cable, C+, Level VI	A 16-00066
					Scale: 1:1 Sheet 2 of 2

5

4

3

2

1