

General Description

The MAX2634 Evaluation Kit (EV Kit) simplifies the evaluation of the MAX2634, 315MHz/433MHz low-noise amplifier for automotive RKE. It enables testing of the device's RF performance and require no additional supporting circuitry. The EV Kit provides 50Ω SMA connectors for inputs and outputs.

Features

- Easy Evaluation of MAX2634 IC
- 2.2V to 5.5V Single-Supply Operation
- RF Inputs and Outputs Matched to 50Ω
- Fully Assembled and Tested

Ordering Information appears at end of data sheet.

EV Kit Photo

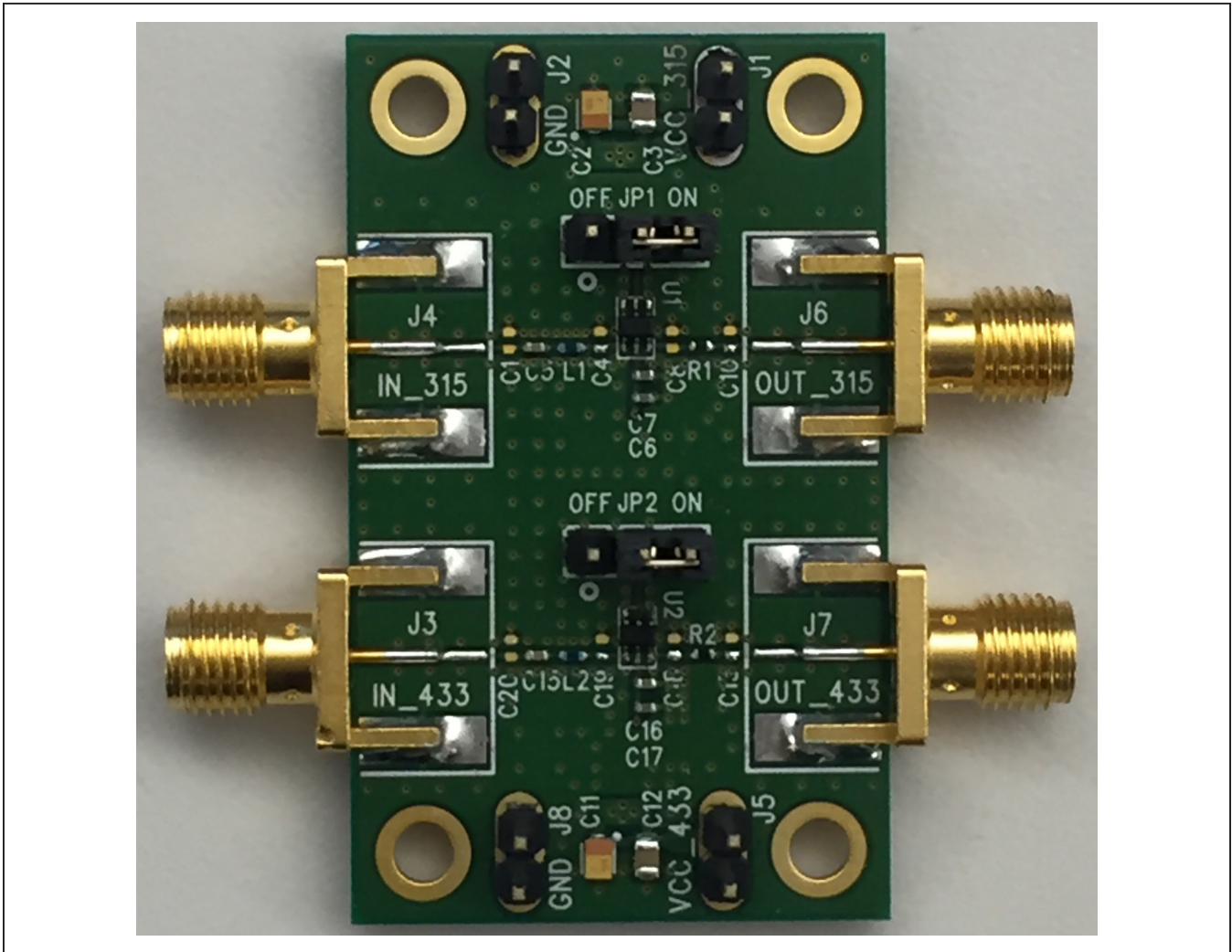

Quick Start

The MAX2634 EV Kit is fully assembled and factory tested. Follow the instructions in the “**connections and Setup**” section to test the devices.

Required Equipment

This section lists the recommended test equipment to verify the operation of the MAX2634. The equipment’s listed are intended as suggestions and substitutions are possible:

- MAX2634 EV Kit
- One DC Power Supply capable of delivering 10mA of current from +2.2V to 5.5V
- One Ammeter (optional)
- One RF Signal Generators capable of delivering RF up to 2GHz (Agilent E4433B or equivalent)
- One RF Spectrum Analyzer that covers the MAX2634 operating frequency range (R&S FSEB20 or equivalent)
- One RF Power Meter capable of measuring up to 0dBm at 315MHz and 433MHz (Agilent E4419B or equivalent) and one Power Sensor (HP 346A or equivalent)
- One Noise Figure Meter (optional)
- One noise source (optional)
- One Network Analyzer (optional)

Connections and Setup

This section is a step-by-step guide to operating the EV Kit and its function.

Caution: Do not turn on the DC Power or RF signal generators until all connections are completed.

Checking Power Gain at 315MHz

- 1) With the DC supply output disabled, connect a +3.0V power supply to J1 (VCC_315) header and the power supply ground to J2 (GND) header of the EV Kit (route the positive terminal of the power supply through an ammeter, if desired).
- 2) Set the jumper of JP1 header to the “**ON**” position.
- 3) With the RF signal generator output disabled, connect the generator output to J4 (IN_315) SMA connector on the EV Kit through an SMA Cable. Set the output of the RF signal generator frequency to 315MHz and power level to -40dBm.
- 4) Connect a spectrum analyzer to J6 (OUT_315) SMA connector on the EV kit through an SMA Cable. Set

the spectrum analyzer center frequency to 315MHz, reference level to 0dBm, and span to 1MHz.

- 5) Enable the DC supply output. The supply current should read approximately 2.5mA.
- 6) Enable the RF signal generator output. The spectrum analyzer should display a tone at 315MHz with power level at approximately -24.5dBm.

Checking Power Gain at 433MHz

- 1) With the DC supply output disabled, connect a +3.0V power supply to J5 (VCC_433) header and the power supply ground to J8 (GND) header of the EV Kit (route the positive terminal of the power supply through an ammeter, if desired).
- 2) Set the jumper of JP2 header to the “**ON**” position.
- 3) With the RF signal generator output disabled, connect the generator output to J3 (IN_433) SMA connector on the EV Kit through an SMA Cable. Set the output of the RF signal generator frequency to 433MHz and power level to -40dBm.
- 4) Connect a spectrum analyzer to J7 (OUT_433) SMA connector on the EV kit through an SMA Cable. Set the spectrum analyzer center frequency to 433MHz, reference level to 0dBm, and span to 1MHz.
- 5) Enable the DC supply output. The supply current should read approximately 2.5mA.
- 6) Enable the RF signal generator output. The spectrum analyzer should display a tone at 433MHz with power level at approximately -26.5dBm.

Checking Noise Figure at 315MHz

- 1) With the DC supply output disabled, connect a +3.0V power supply to J1 (VCC_315) header and the power supply ground to J2 (GND) header of the EV Kit.
- 2) Set the jumper of JP1 header to the “**ON**” position.
- 3) Calibrate the noise figure meter per the instructions for that instrument.
- 4) Connect the noise source to J4 (IN_315) SMA connector and J6 (OUT_315) SMA connector to the noise figure meter using a SMA cable.
Note: It is highly recommended to measure noise figure inside a screen room or Faraday enclosure to avoid environmental noise from increasing the noise figure artificially.
- 5) Enable the DC supply output.
- 6) Enable the noise figure measurement. The NF should measure approximately 1.25dB.

Checking Noise Figure at 433MHz

- 1) With the DC supply output disabled, connect a +3.0V power supply to J5 (VCC_433) header and the power supply ground to J8 (GND) header of the EV Kit.
- 2) Set the jumper of JP2 header to the “ON” position.
- 3) Calibrate the noise figure meter per the instructions for that instrument.
- 4) Connect the noise source to J3 (IN_433) SMA connector and J7 (OUT_433) SMA connector to the noise figure meter using a SMA cable.
- 5) Enable the DC supply output.
- 6) Enable the noise figure measurement. The NF should measure approximately 1.25dB.

Layout Information

A properly designed PCB is essential to any RF/micro-wave circuit. Use controlled-impedance lines on all high-frequency inputs and outputs. Bypass with decoupling capacitors located close to the device’s VCC pin. For long VCC lines, it may be necessary to add additional decoupling capacitors. These additional capacitors can be located farther away from the device package. Proper grounding of the GND pins is essential. If the PCB uses a topside RF ground, connect it directly to all GND pins. For a board where the ground plane is not on the component layer, the best technique is to connect the GND pins to the board with a plated through-hole located close to the package.

Performance Table

FREQUENCY (MHZ)	L1 (NH)	SUPPLY CURRENT (MA)	GAIN (DB)	NOISE FIGURE (DB)	INPUT P1DB (DBM)	INPUT IP3 (DBM)
308	56	2.5	15.5	1.25	-29	-16
315	56	2.5	15.5	1.25	-29	-16
418	33	2.5	13.5	1.25	-26	-12
433.92	33	2.5	13.5	1.25	-26	-12

Component Suppliers

SUPPLIER	WEBSITE
AVX	http://www.avx.com/
Murata	http://www.murata.com/
Sullins Electronics Corps.	https://www.DigiKey.com/Sullins
Johnson Components (Cinch Connectivity Solutions)	https://cinchconnectivity.com/

Note: Indicate that you are using the MAX2634 when contacting these component suppliers.

Ordering Information

PART	TYPE
MAX2634EVKIT+	EV Kit

+Denotes lead(Pb)-free and RoHS compliant.

MAX2634 EV Kit Bill of Materials

LF / RoHS	Ref Designator	Qty	Value	Tol	Description	Manufacturer	Part Number	Maxim Supplied	E#
--	C1, C4, C8, C10, C13, C18, C19, C20	0	Do Not Install		0402 Capacitor	Murata	Leave Site Open		--
Y	C2, C11	2	10uF	10%	Tantalum Capacitor, 'R' Case	AVX	TAJR106K006	X	EC0629
Y	C3, C12	2	4.7uF	10%	0805 Capacitor	Murata	GRM219R61A475K	X	ECM0566
Y	C5, C15	2	0.022uF	10%	0402 Capacitor	Murata	GRM155R71C223K	X	ECM0193
Y	C6, C17	2	100pF	5%	0402 Capacitor	Murata	GRM1555C1H101J	X	ECM0122
Y	C7, C16	2	0.01uF	10%	0402 Capacitor	Murata	GRM155R71C103K	X	ECM0510
Y	R1, R2	2	0 ohm		0402 Resistor		Use Lead-Free Parts Only		ER0504020R00
Y	L1	1	56nH	3%	0402 Inductor	Murata	LQW15AN56NH00	X	EL1191
Y	L2	1	33nH	3%	0402 Inductor	Murata	LQW15AN33NH00	X	EL0458
Y	U1, U2	2	MAX2634		LNA with Shutdown	Maxim Integrated Products, Inc.	MAX2634AXT+	X	EU02371
Y	J1, J2, J5, J8	4	1X2 Pin Header		In-Line Header, 100 mil centers	Sullins	PEC36SAAN		EH0072
Y	JP1, JP2	2	1X3 Pin Header		In-Line Header, 100 mil centers	Sullins	PEC36SAAN		EH0072
Y	J3, J4, J6, J7	4	Connector		SMA End Launch Jack Receptacle 0.062"	Johnson	142-0701-801		EH0052
Y	JP1, JP2 Install on Pins 1 and 2	2	Shunt		Shorting Jumper	Sullins	SSC02SYAN		EH0071
Y		1			MAX2634 Evaluation Kit+ Circuit Board	--	--		--

MAX2634 EV Kit Schematic

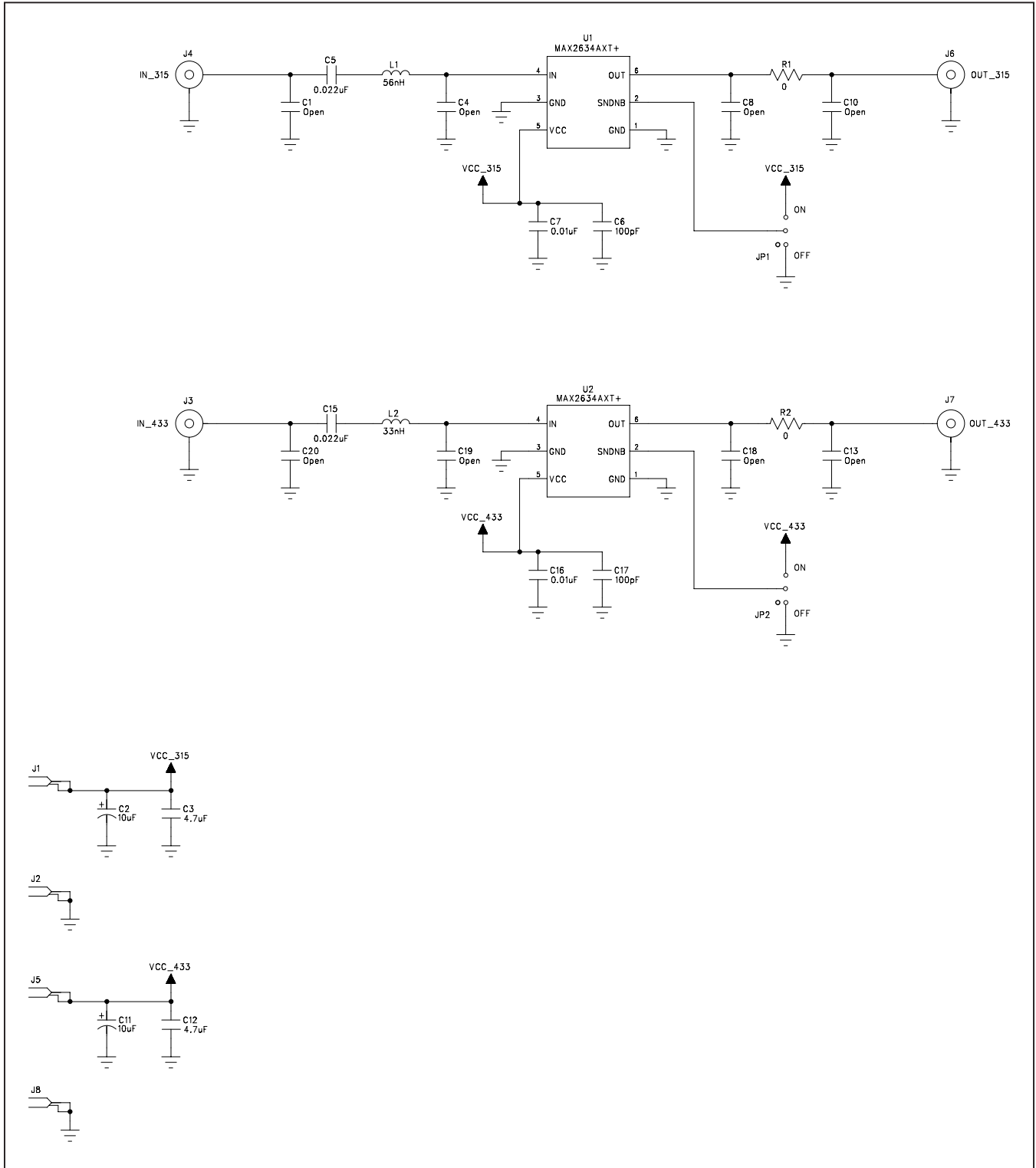

MAX2634 EV Kit PCB Layout Diagrams

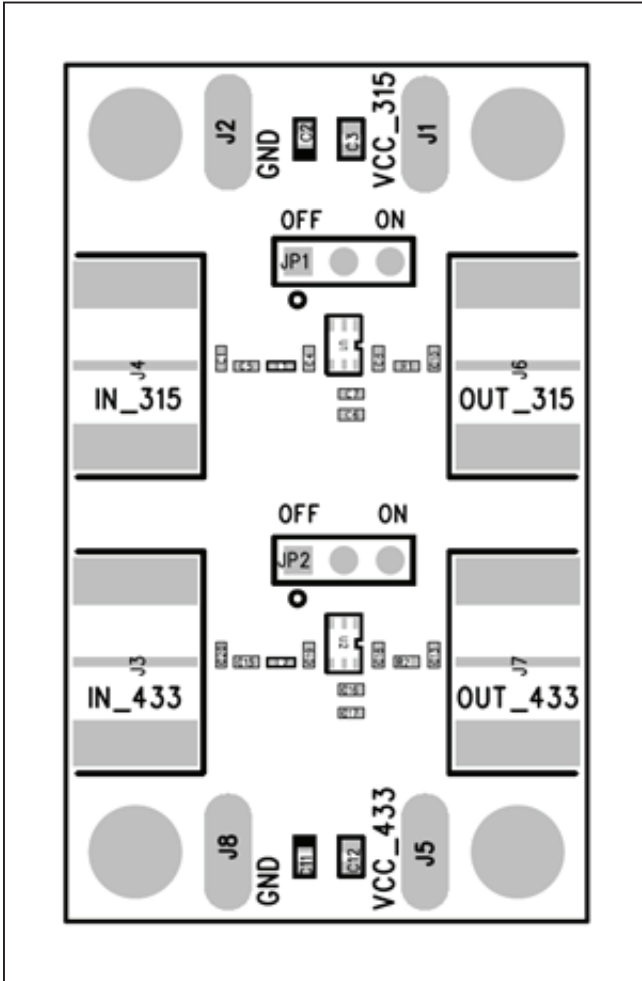

MAX2634 EV Kit—Assembly

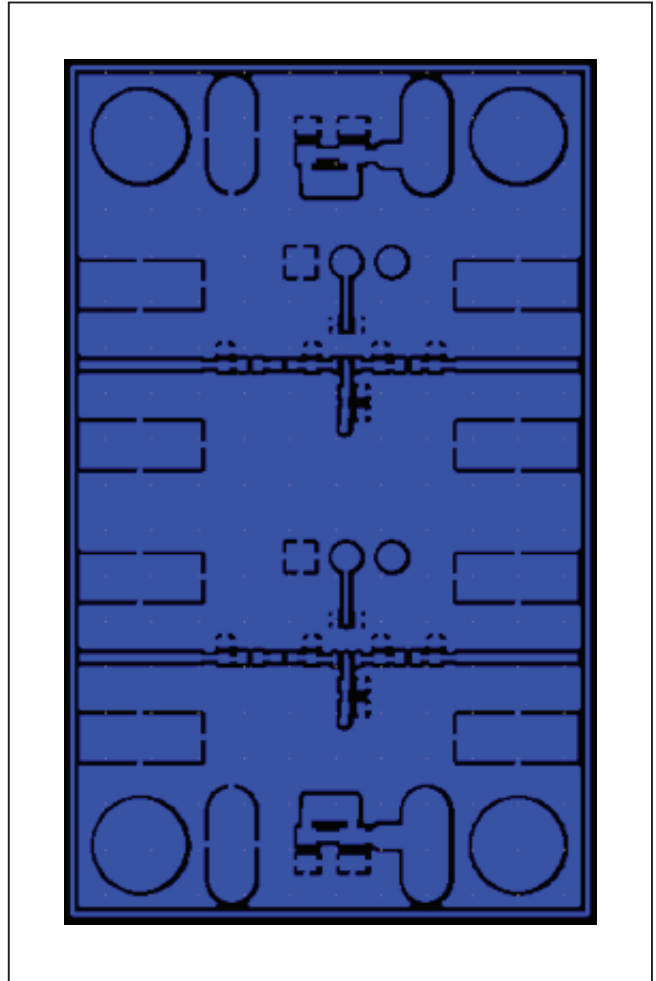

MAX2634 EV Kit—Top Layer

MAX2634 EV Kit PCB Layout Diagrams (continued)

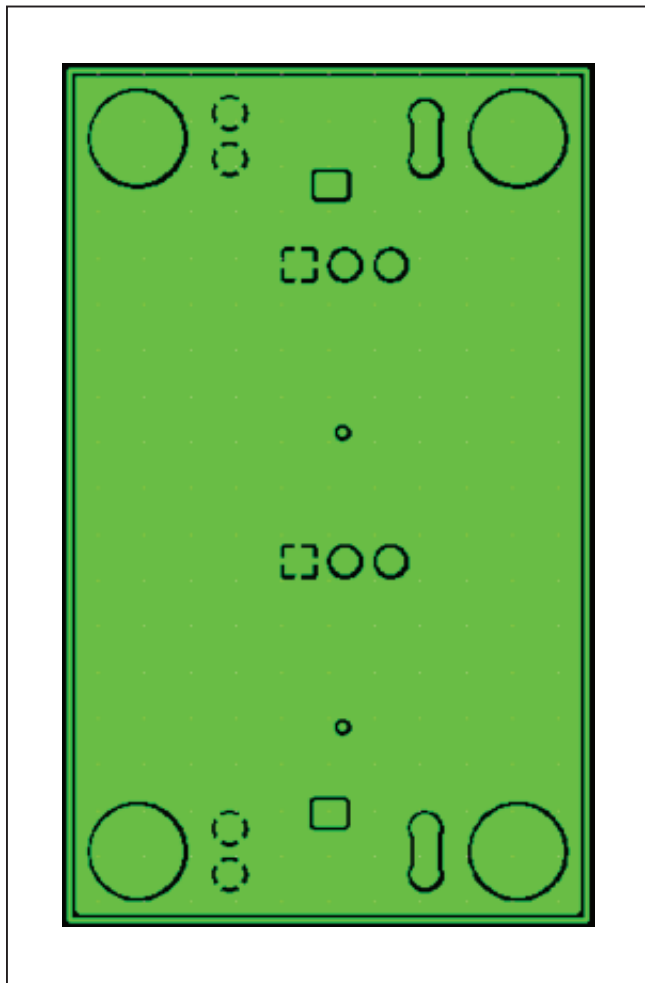

MAX2634 EV Kit—Layer 2

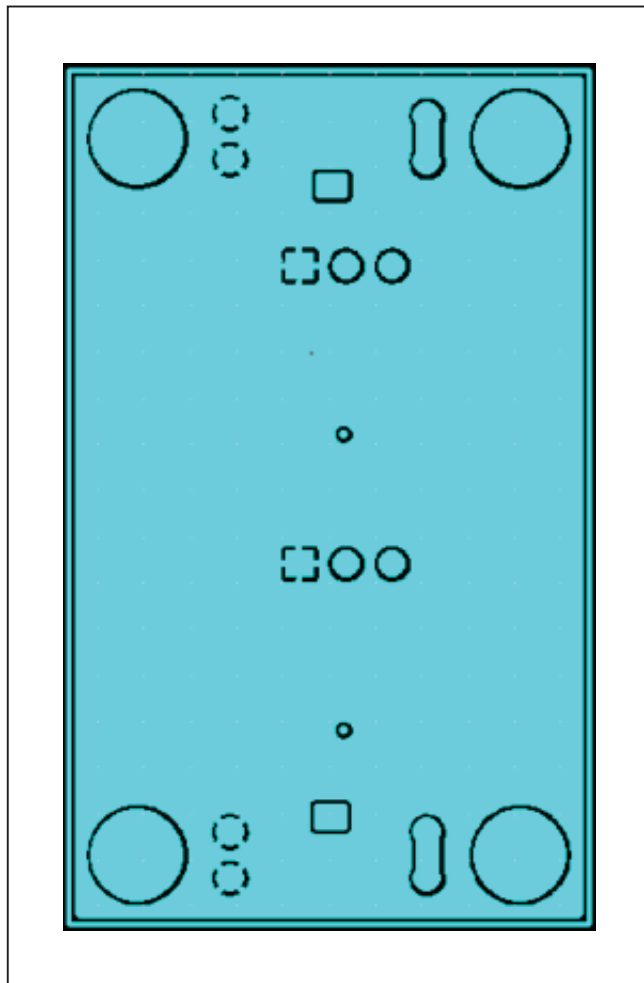

MAX2634 EV Kit—Layer 3

MAX2634 EV Kit PCB Layout Diagrams (continued)

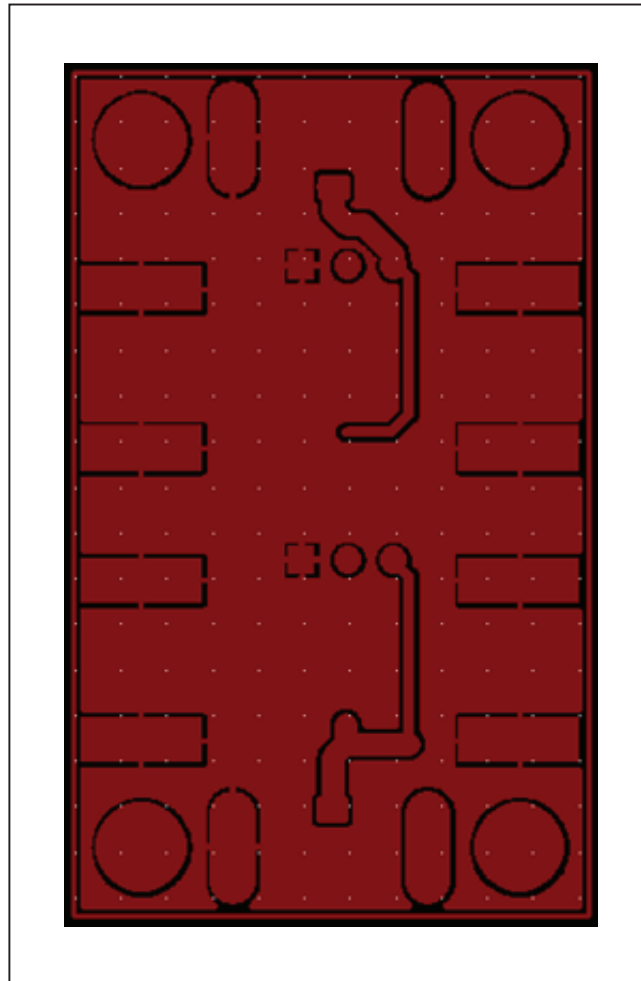

MAX2634 EV Kit—Bottom Layer

Revision History

REVISION NUMBER	REVISION DATE	DESCRIPTION	PAGES CHANGED
0	7/17	Initial release	—

For pricing, delivery, and ordering information, please contact Maxim Direct at 1-888-629-4642, or visit Maxim Integrated's website at www.maximintegrated.com.

Maxim Integrated cannot assume responsibility for use of any circuitry other than circuitry entirely embodied in a Maxim Integrated product. No circuit patent licenses are implied. Maxim Integrated reserves the right to change the circuitry and specifications without notice at any time.