



Economy Power 2.5

TE Internal #: 1-1969443-4

TPA (Terminal Position Assurance), Black, Nylon GF, 14 Position, Economy Power 2.5

[View on TE.com >](#)

Connectors > Connector Accessories > Connector Hardware

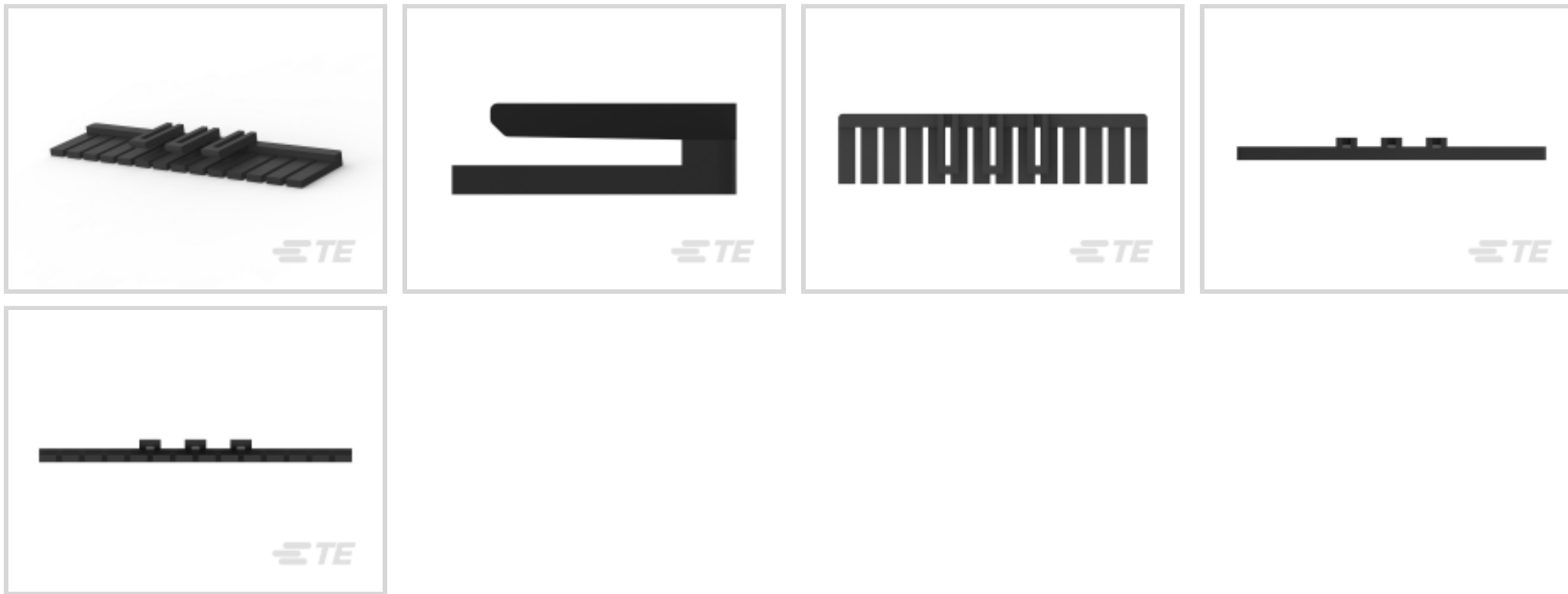

Hardware Accessory Function: **Position Assurance**

Connector Hardware Accessory Type: **TPA (Terminal Position Assurance)**

Primary Product Color: **Black**

Primary Product Material: **Nylon GF**

Number of Positions: **14**

**Features**

**Product Type Features**

Hardware Accessory Function	Position Assurance
Connector Hardware Accessory Type	TPA (Terminal Position Assurance)

**Configuration Features**

Number of Rows	1
Number of Positions	14

**Body Features**

Primary Product Color	Black
Primary Product Material	Nylon GF

**Housing Features**

Centerline (Pitch)	2.5 mm[.098 in]
--------------------	-----------------

**Dimensions**

Product Length	34.4 mm[1.354 in]
Product Height	2.51 mm[.099 in]

**Usage Conditions**



Operating Temperature (Max)	105 °C[221 °F]
Operating Temperature Range	-55 - 105 °C[-67 - 221 °F]

### Industry Standards

Glow Wire Rating	Standard Part - Not Glow Wire
------------------	-------------------------------

### Packaging Features

Packaging Quantity	600
Packaging Method	Bag

### Product Compliance

[For compliance documentation, visit the product page on TE.com>](#)

EU RoHS Directive 2011/65/EU	Compliant
EU ELV Directive 2000/53/EC	Compliant
China RoHS 2 Directive MIIT Order No 32, 2016	No Restricted Materials Above Threshold
EU REACH Regulation (EC) No. 1907/2006	Current ECHA Candidate List: JAN 2024 (240) Candidate List Declared Against: JAN 2024 (240) Does not contain REACH SVHC
Halogen Content	Not Low Halogen - contains Br or Cl > 900 ppm.
Solder Process Capability	Not applicable for solder process capability

#### Product Compliance Disclaimer

This information is provided based on reasonable inquiry of our suppliers and represents our current actual knowledge based on the information they provided. This information is subject to change. The part numbers that TE has identified as EU RoHS compliant have a maximum concentration of 0.1% by weight in homogenous materials for lead, hexavalent chromium, mercury, PBB, PBDE, DBP, BBP, DEHP, DIBP, and 0.01% for cadmium, or qualify for an exemption to these limits as defined in the Annexes of Directive 2011/65/EU (RoHS2). Finished electrical and electronic equipment products will be CE marked as required by Directive 2011/65/EU. Components may not be CE marked. Additionally, the part numbers that TE has identified as EU ELV compliant have a maximum concentration of 0.1% by weight in homogenous materials for lead, hexavalent chromium, and mercury, and 0.01% for cadmium, or qualify for an exemption to these limits as defined in the Annexes of Directive 2000/53/EC (ELV). Regarding the REACH Regulation, the information TE provides on SVHC in articles for this part number is based on the latest European Chemicals Agency (ECHA) 'Guidance on requirements for substances in articles' posted at this URL: <https://echa.europa.eu/guidance-documents/guidance-on-reach>

### Compatible Parts



## Also in the Series | Economy Power 2.5

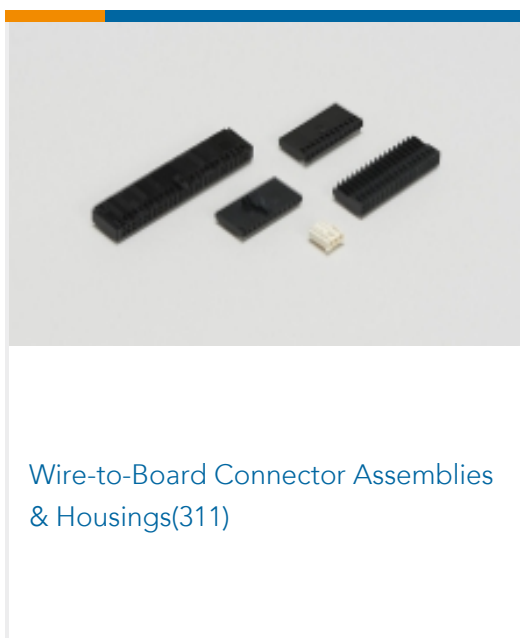
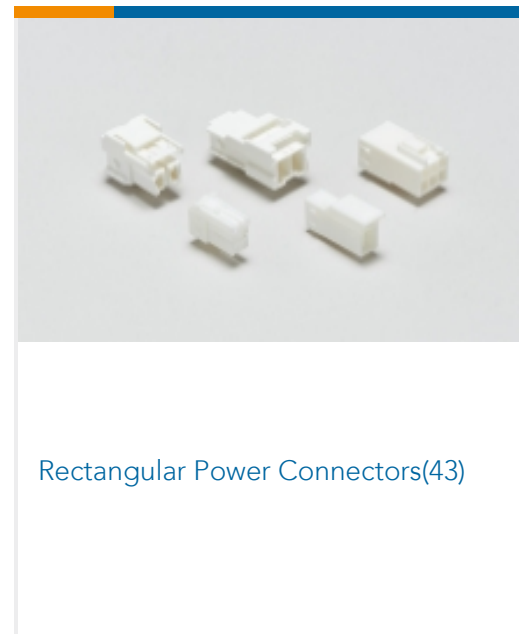
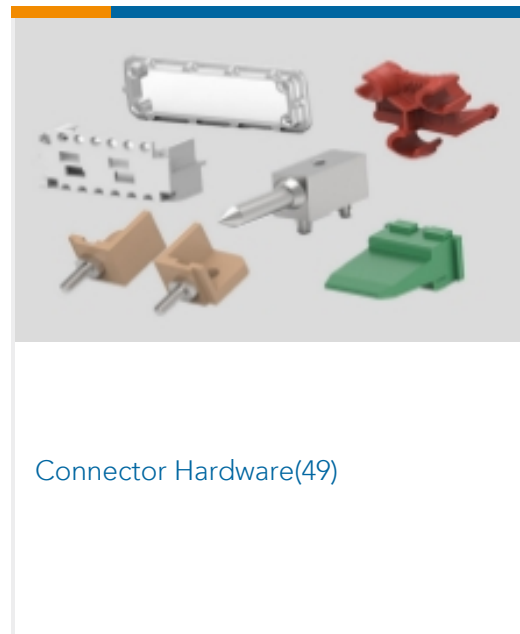
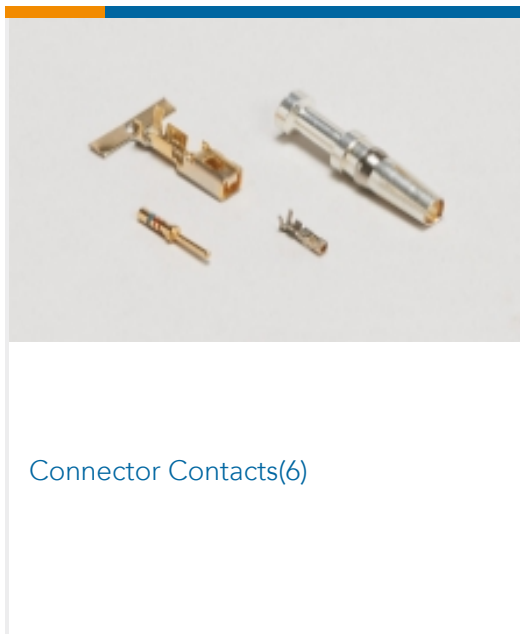

## Customers Also Bought





TE Part # 1969443-4  
EP 2.5 TPA Retainer, 4 Pos

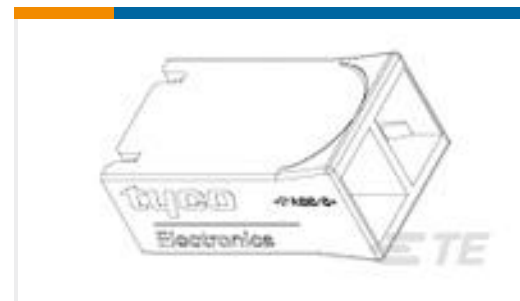

TE Part # 521766-1  
250 HSG. PL MKIII REC. 10mm 2P NAT

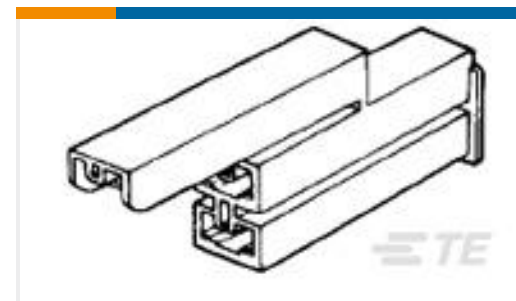

TE Part # 1-172075-1  
3 POS PL 187(4.8 MM) HOUSING  
NATURAL



TE Part # 1-2315717-2  
STD TIMER PLUG HSG 2P MKII



TE Part # 6-1534796-4  
AMP DUOPLUG MARK II  
CONNECTOR



TE Part # EP96376001  
VERSAFIT-1/4-0-30MM

## Documents

### CAD Files

#### 3D PDF

3D

#### Customer View Model

[ENG\\_CVM\\_CVM\\_1-1969443-4\\_B.2d\\_dxf.zip](#)

English

#### Customer View Model

[ENG\\_CVM\\_CVM\\_1-1969443-4\\_B.3d\\_igs.zip](#)

English

#### Customer View Model

[ENG\\_CVM\\_CVM\\_1-1969443-4\\_B.3d\\_stp.zip](#)

English

By downloading the CAD file I accept and agree to the [Terms and Conditions](#) of use.

### Datasheets & Catalog Pages

[7-1773461-6\\_EP2.5\\_Connector\\_Series](#)

English

### Product Specifications

[Application Specification](#)

English

### Instruction Sheets

[Instruction Sheet \(U.S.\)](#)

English