

2-1418480-1  ACTIVE

AMP | Heavy Duty Sealed Connector Series

TE Internal #: 2-1418480-1

Housing for Female Terminals, Wire-to-Wire, 7 Position, .157 in / .236 in [6 mm / 4 mm] Centerline, Sealable, Gray, Heavy Duty Sealed Connector Series

[View on TE.com >](#)



Connectors > Automotive Connectors > Automotive Housings > Heavy Duty Sealed Connector Series Housings



Connector System: **Wire-to-Wire**

Number of Positions: 7

Connector & Housing Type: **Housing for Female Terminals**

Centerline (Pitch): 4 mm, 6 mm [ .157 in, .236 in ]

Sealable: **Yes**

[All Heavy Duty Sealed Connector Series Housings \(204\)](#)

## Features

### Product Type Features

Mixed & Hybrid Connector	Yes
Connector Shape	Rectangular
Connector System	Wire-to-Wire
Connector & Housing Type	Housing for Female Terminals
Sealable	Yes
Primary Locking Feature	On the Terminal

### Configuration Features

Number of Positions	7
Number of Rows	2

### Electrical Characteristics

Operating Voltage	60 VDC
Nominal Voltage Architecture	12 V, 24 V, 42 V, 60 V

### Body Features

Cable Exit Angle	180°, 90°
Primary Product Color	Gray
Connector & Keying Code	B



### Contact Features

Contact Size	1.5K, 2.8mm
Contact Type	Receptacle
Mating Tab Width	1.5 mm, 2.8 mm [.059 in][.11 in]
Contact Current Rating (Max)	40 A

### Mechanical Attachment

Terminal Position Assurance	Yes
Strain Relief	Without
Mating Alignment Type	Keyed
Mating Alignment	With
Connector Mounting Type	Cable Mount (Free-Hanging)

### Housing Features

Housing Material	PBT GF
Centerline (Pitch)	4 mm, 6 mm [.157 in][.236 in]

### Dimensions

Connector Height	31.25 mm [1.23 in]
Product Width	25.7 mm [1.012 in]
Product Length	44 mm [1.732 in]
Row-to-Row Spacing	2.54 mm [.1 in]

### Usage Conditions

Operating Temperature (Max)	70 °C, 80 °C, 85 °C, 90 °C, 100 °C, 105 °C, 110 °C, 120 °C, 125 °C, 130 °C, 140 °C [158 °F][167 °F][176 °F][185 °F][194 °F][212 °F][221 °F][230 °F][248 °F][257 °F][266 °F][284 °F]
Operating Temperature Range	-40 - 140 °C [-40 - 284 °F]

### Operation/Application

Circuit Application	Signal
---------------------	--------

### Industry Standards

Degree of Protection	IP67
UL Flammability Rating	UL 94V-0

### Packaging Features

Packaging Quantity	380
Packaging Method	Box



Other

Serviceable	Yes
Connector Position Assurance Capable	No

Product Compliance



[For compliance documentation, visit the product page on TE.com>](#)

EU RoHS Directive 2011/65/EU	Compliant
EU ELV Directive 2000/53/EC	Compliant
China RoHS 2 Directive MIIT Order No 32, 2016	No Restricted Materials Above Threshold
EU REACH Regulation (EC) No. 1907/2006	Current ECHA Candidate List: JAN 2024 (240) Candidate List Declared Against: JAN 2024 (240) Does not contain REACH SVHC
Halogen Content	Not Low Halogen - contains Br or Cl > 900 ppm.
Solder Process Capability	Not applicable for solder process capability

Product Compliance Disclaimer

This information is provided based on reasonable inquiry of our suppliers and represents our current actual knowledge based on the information they provided. This information is subject to change. The part numbers that TE has identified as EU RoHS compliant have a maximum concentration of 0.1% by weight in homogenous materials for lead, hexavalent chromium, mercury, PBB, PBDE, DBP, BBP, DEHP, DIBP, and 0.01% for cadmium, or qualify for an exemption to these limits as defined in the Annexes of Directive 2011/65/EU (RoHS2). Finished electrical and electronic equipment products will be CE marked as required by Directive 2011/65/EU. Components may not be CE marked. Additionally, the part numbers that TE has identified as EU ELV compliant have a maximum concentration of 0.1% by weight in homogenous materials for lead, hexavalent chromium, and mercury, and 0.01% for cadmium, or qualify for an exemption to these limits as defined in the Annexes of Directive 2000/53/EC (ELV). Regarding the REACH Regulation, the information TE provides on SVHC in articles for this part number is based on the latest European Chemicals Agency (ECHA) 'Guidance on requirements for substances in articles' posted at this URL: <https://echa.europa.eu/guidance-documents/guidance-on-reach>

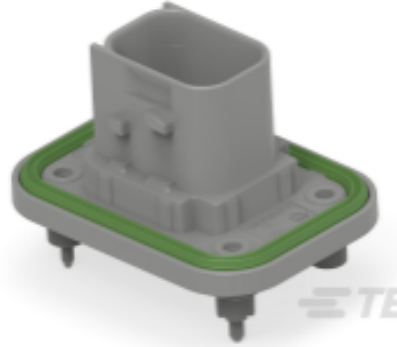
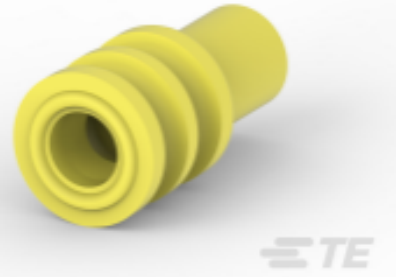
Compatible Parts

 <p>TE Part # CAT-H3399-CH8172 Heavy Duty Sealed Connector Series Housings</p>	 <p>TE Part # 2-2378180-1 7POS, HYBRID, HDR ASSY, 180DEG, COD B</p>	 <p>TE Part # 964972-1 EINZELLEITERDICHTUNG</p>	 <p>TE Part # 828905-1 SINGLE-WIRE-SEAL(5MM HOLE)</p>
---	--	--	--





TE Part # 2112301-1  
PROTECTION CAP, FOR REC.HSG GROUP C



TE Part # CAT-H3399-B128  
Heavy Duty Sealed Connector Series Backshells



TE Part # CAT-AM705-T273  
AMP MCP, RECEPTACLE AND TAB



TE Part # 2-2425849-1  
7POS, HYBRID, HDR ASSY, 90DEG, COD B

Also in the Series | **Heavy Duty Sealed Connector Series**



Automotive Connector Caps & Covers (25)



Automotive Housings (207)



Connector Seals & Cavity Plugs (5)



Data Connectivity Headers (2)



Data Connectivity Housings (16)



Other Automotive Connector Accessories (34)



PCB Headers & Receptacles (1)

Customers Also Bought



TE Part # 1-1418480-1  
Heavy Duty Sealed Connector Series Housings



TE Part # 2134055-1  
DYNAMIC D7100 SOCKET HSG ASSY 4P XX



TE Part # 1418884-3  
AMP MCP, RECEPTACLE AND TAB



TE Part # 1981823-1  
DYNAMIC D7100 HDR ASSY H 4P XX SQ

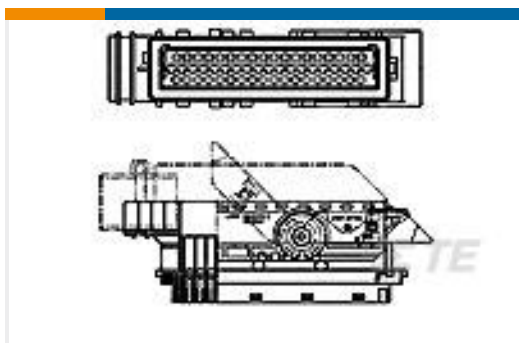

TE Part # 963041-1  
55P JUN-POW-TIM GEH



## Documents

### Product Drawings

[7 POS MIXED REC HSG GR](#)

English

---

### CAD Files

Customer View Model

[ENG\\_CVM\\_CVM\\_2-1418480-1\\_J.2d\\_dxf.zip](#)

English

[3D PDF](#)

3D

Customer View Model

[ENG\\_CVM\\_CVM\\_2-1418480-1\\_J.3d\\_igs.zip](#)

English

Customer View Model

[ENG\\_CVM\\_CVM\\_2-1418480-1\\_J.3d\\_stp.zip](#)

English

By downloading the CAD file I accept and agree to the [Terms and Conditions](#) of use.

---

### Datasheets & Catalog Pages

[HDSCS Catalog](#)

English

[ICT Terminals and Connectors Catalogue](#)

English

[CONNECTOR SELECTOR](#)

English

---

### Product Specifications

[Application Specification](#)

English