

41898 ✓ ACTIVE

FASTON | FASTON 250

TE Internal #: 41898

Quick Disconnects, Receptacle, 18 - 12 AWG Wire Size, .82 - 3.31 mm<sup>2</sup> Wire Size, Mating Tab Width 6.35 mm [.25 in], Flag, Brass, FASTON 250

[View on TE.com >](#)



Terminals & Splices > Quick Disconnects



Quick Disconnect Terminal Type: **Receptacle**

Wire Size: **.82 - 3.31 mm<sup>2</sup>**

Mating Tab Width: **6.35 mm [.25 in]**

Mating Tab Thickness: **.81 mm [.032 in]**

## Features

### Product Type Features

Insertion Force	Normal
-----------------	--------

### Configuration Features

Connection Capacity	Single
Compatible With Wire & Cable Type	Discrete Wire

### Contact Features

Quick Disconnect Terminal Type	Receptacle
Mating Tab Width	6.35 mm [.25 in]
Mating Tab Thickness	.81 mm [.032 in]
Terminal Orientation	Flag
Contact Base Material	Brass
Terminal Plating Material	Tin
Crimp Type	Tab-Lok
Barrel Type	Open

### Termination Features



Product Terminates To	Wire & Cable
-----------------------	--------------

### Mechanical Attachment

Wire Insulation Support	With
-------------------------	------

### Dimensions

Terminal Material Thickness	.43 mm[.017 in]
-----------------------------	-----------------

Compatible Insulation Diameter Range	2.79 - 5.33 mm[.11 - .21 in]
--------------------------------------	------------------------------

Wire Size	.82 - 3.31 mm <sup>2</sup>
-----------	----------------------------

### Usage Conditions

Insulation Option	Uninsulated
-------------------	-------------

Operating Temperature Range	-40 - 110 °C[-40 - 230 °F]
-----------------------------	----------------------------

### Industry Standards

Compatible With Agency/Standards Products	CSA, UL
---	---------

### Packaging Features

Packaging Quantity	1000
--------------------	------

Packaging Method	Loose Piece/Carton
------------------	--------------------

### Other

Line	Premier
------	---------

## Product Compliance

[For compliance documentation, visit the product page on TE.com>](#)

EU RoHS Directive 2011/65/EU	Compliant
------------------------------	-----------

EU ELV Directive 2000/53/EC	Compliant
-----------------------------	-----------

China RoHS 2 Directive MIIT Order No 32, 2016	No Restricted Materials Above Threshold
---	---

EU REACH Regulation (EC) No. 1907/2006	Current ECHA Candidate List: JAN 2024 (240) Candidate List Declared Against: JAN 2024 (240) Does not contain REACH SVHC
--	---

Halogen Content	Low Halogen - Br, Cl, F, I < 900 ppm per homogenous material. Also BFR/CFR/PVC Free
-----------------	---

Solder Process Capability	Not applicable for solder process capability
---------------------------	--

Product Compliance Disclaimer



This information is provided based on reasonable inquiry of our suppliers and represents our current actual knowledge based on the information they provided. This information is subject to change. The part numbers that TE has identified as EU RoHS compliant have a maximum concentration of 0.1% by weight in homogenous materials for lead, hexavalent chromium, mercury, PBB, PBDE, DBP, BBP, DEHP, DIBP, and 0.01% for cadmium, or qualify for an exemption to these limits as defined in the Annexes of Directive 2011/65/EU (RoHS2). Finished electrical and electronic equipment products will be CE marked as required by Directive 2011/65/EU. Components may not be CE marked. Additionally, the part numbers that TE has identified as EU ELV compliant have a maximum concentration of 0.1% by weight in homogenous materials for lead, hexavalent chromium, and mercury, and 0.01% for cadmium, or qualify for an exemption to these limits as defined in the Annexes of Directive 2000/53/EC (ELV). Regarding the REACH Regulation, the information TE provides on SVHC in articles for this part number is based on the latest European Chemicals Agency (ECHA) 'Guidance on requirements for substances in articles' posted at this URL: <https://echa.europa.eu/guidance-documents/guidance-on-reach>

## Compatible Parts



TE Part # 60583-2  
250 FASTON FLAG REC 12-10 AWG TPBR



TE Part # 47417  
DAHT FASTON STRAIGHT 18-14 ASSY



TE Part # 60851-3  
250 FASTON REC 12-10 AWG TPBR



TE Part # 60583-1  
250 FASTON FLAG REC 12-10 AWG SPBZ

## Also in the Series | FASTON 250



Compression Connectors(4)



Crimp Terminal Housings(133)



Insertion & Extraction Tools(6)



Magnet Wire Terminals(1)



PCB Terminals(134)



Quick Disconnects(441)



Splices(4)

## Customers Also Bought

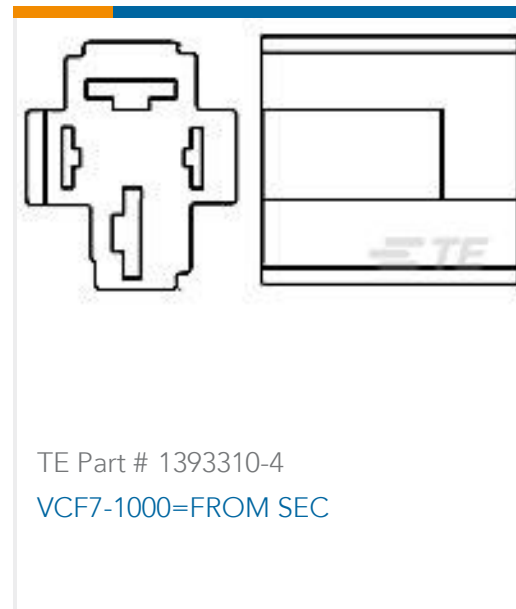
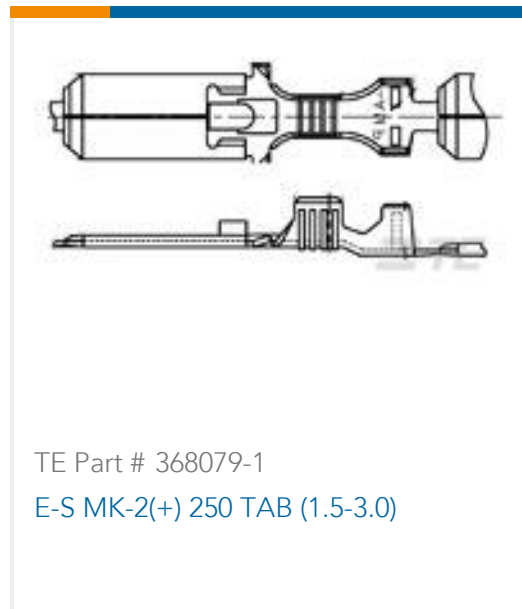
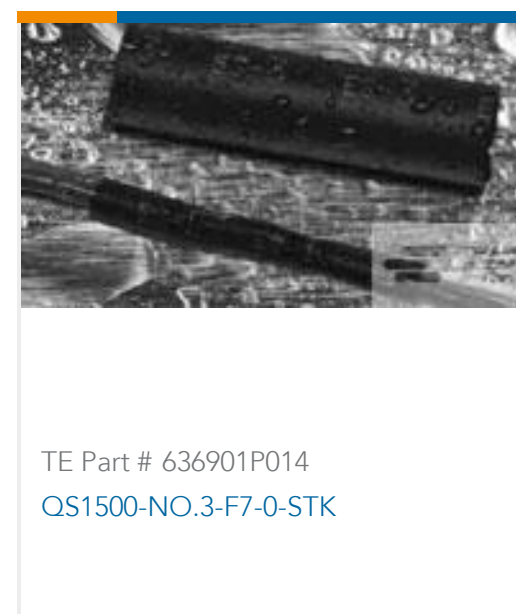

## Documents

### Product Drawings

250 FASTON FLAG REC 18-12 AWG TPBR

English

### CAD Files

Customer View Model

[ENG\\_CVM\\_CVM\\_41898\\_U.2d\\_dxf.zip](#)

English

### 3D PDF

3D

Customer View Model

[ENG\\_CVM\\_CVM\\_41898\\_U.3d\\_igs.zip](#)

English

Customer View Model

[ENG\\_CVM\\_CVM\\_41898\\_U.3d\\_stp.zip](#)

English

By downloading the CAD file I accept and agree to the [Terms and Conditions](#) of use.

## Datasheets & Catalog Pages



[FASTIN\\_FASTON\\_Product\\_Line](#)

English

---

[Product Specifications](#)

[Engineering Report](#)

English

---

[Agency Approvals](#)

[UL Report](#)

English

[UL Report](#)

English