

172159-1 ✓ ACTIVE

MATE-N-LOK | Mini-Universal MATE-N-LOK

TE Internal #: 172159-1

Rectangular Power Connectors, Housing, Receptacle, Wire-to-Wire / Wire-to-Panel, 4 Position, 4.2 mm [.165 in] Centerline, Mini-Universal MATE-N-LOK

[View on TE.com >](#)



Connectors > Power Connectors > Rectangular Power > Rectangular Power Connectors



Rectangular Power Connector Type: **Housing**

Connector & Housing Type: **Receptacle**

Connector System: **Wire-to-Panel, Wire-to-Wire**

Number of Positions: **4**

Centerline (Pitch): **4.2 mm [.165 in]**

## Features

### Product Type Features

Rectangular Power Connector Type	Housing
Connector & Housing Type	Receptacle
Connector System	Wire-to-Panel, Wire-to-Wire
Sealable	No
Connector & Contact Terminates To	Wire & Cable

### Configuration Features

Number of Positions	4
Number of Rows	2

### Electrical Characteristics

Operating Voltage	600 VDC
-------------------	---------

### Contact Features

Multiple Contact Types	Without
Contact Retention Within Housing	Without
Contact Type	Pin



### Termination Features

Termination Method to Wire & Cable	Crimp
------------------------------------	-------

### Mechanical Attachment

Panel Mount Feature	With
Panel Mount Feature Type	Mounting Ears
Connector Mounting Type	Panel Mount

### Housing Features

Centerline (Pitch)	4.2 mm [.165 in]
Housing Color	Natural
Housing Material	Nylon 66

### Dimensions

Panel Thickness (Recommended)	.8 - 2 mm [.031 - .078 in]
Connector Height	9.8 mm
Product Width	9.8 mm
Product Length	11.8 mm
Row-to-Row Spacing	4.2 mm [.165 in]

### Usage Conditions

Operating Temperature Range	-20 - 105 °C [-4 - 221 °F]
-----------------------------	----------------------------

### Operation/Application

Circuit Application	Power & Signal
---------------------	----------------

### Industry Standards

CSA Rating	Certified, LR 7189
UL Rating	Recognized
Compatible With Agency/Standards Products	CSA, UL
Compatible With Approved Standards Products	UL E28476
UL Flammability Rating	UL 94V-0
Glow Wire Rating	Standard Part - Not Glow Wire

### Packaging Features

Packaging Quantity	500
Packaging Method	Bag

## Product Compliance



[For compliance documentation, visit the product page on TE.com>](#)

EU RoHS Directive 2011/65/EU	Compliant
EU ELV Directive 2000/53/EC	Compliant
China RoHS 2 Directive MIIT Order No 32, 2016	No Restricted Materials Above Threshold
EU REACH Regulation (EC) No. 1907/2006	Current ECHA Candidate List: JAN 2024 (240) Candidate List Declared Against: JAN 2024 (240) Does not contain REACH SVHC
Halogen Content	Low Halogen - Br, Cl, F, I < 900 ppm per homogenous material. Also BFR/CFR/PVC Free
Solder Process Capability	Not applicable for solder process capability





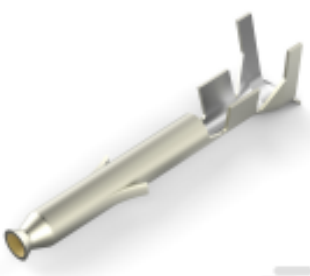











### Product Compliance Disclaimer

This information is provided based on reasonable inquiry of our suppliers and represents our current actual knowledge based on the information they provided. This information is subject to change. The part numbers that TE has identified as EU RoHS compliant have a maximum concentration of 0.1% by weight in homogenous materials for lead, hexavalent chromium, mercury, PBB, PBDE, DBP, BBP, DEHP, DIBP, and 0.01% for cadmium, or qualify for an exemption to these limits as defined in the Annexes of Directive 2011/65/EU (RoHS2). Finished electrical and electronic equipment products will be CE marked as required by Directive 2011/65/EU. Components may not be CE marked. Additionally, the part numbers that TE has identified as EU ELV compliant have a maximum concentration of 0.1% by weight in homogenous materials for lead, hexavalent chromium, and mercury, and 0.01% for cadmium, or qualify for an exemption to these limits as defined in the Annexes of Directive 2000/53/EC (ELV). Regarding the REACH Regulation, the information TE provides on SVHC in articles for this part number is based on the latest European Chemicals Agency (ECHA) 'Guidance on requirements for substances in articles' posted at this URL: <https://echa.europa.eu/guidance-documents/guidance-on-reach>



## Compatible Parts

 <p>TE Part # 1-770988-1 MINI UMNL SOK 22-18AWG LP LF</p>	 <p>TE Part # 1-770985-0 MINI UMNL PIN 26-22AWG AU LP</p>	 <p>TE Part # 1-770987-0 MINI UMNL PIN 22-18 AWG AU LP</p>	 <p>TE Part # 770988-3 MINI UMNL SOK 22-18AWG AU LP</p>
--	--	---	--

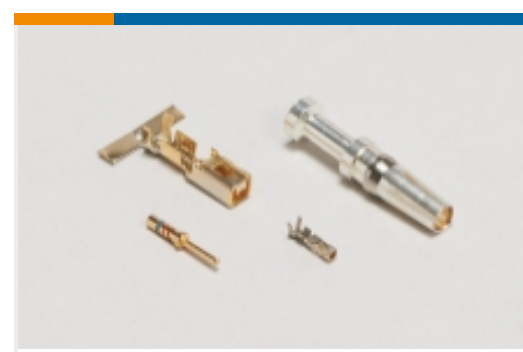

 <p>TE Part # 1-770988-0 MINI UMNL SOK 22-18AWG AU</p>	 <p>TE Part # 1-794059-0 MINI UMNL PIN L/P LF</p>	 <p>TE Part # 770986-1 MINI UMNL SOK 26-22AWG SN LP</p>	 <p>TE Part # 794058-1 MINI UMNL SOK L/P</p>
 <p>TE Part # 170365-3 MINI UNIVERSAL M-N-L SOCKET LP</p>	 <p>TE Part # 170364-3 MINI UNIVERSAL M-N-L PIN LP</p>	 <p>TE Part # 770985-1 MINI UMNL PIN 26-22AWG SN LP</p>	 <p>TE Part # 1-794407-1 MINI UMNL SOK 20-16 AWG AU LF</p>
 <p>TE Part # 170363-3 MINI UNIVERSAL M-N-L PIN LP</p>	 <p>TE Part # 171638-1 MINI U-M-N-L PIN CONT. LP</p>	 <p>TE Part # 171639-1 MINI U-M-N-L SOCKET LP</p>	 <p>TE Part # 770903-3 MINI UMNL PIN 22-18 AWG AU</p>
 <p>TE Part # 170366-3 MINI UNIVERSAL M-N-L SOCKET LP</p>	 <p>TE Part # 794059-1 MINI UMNL PIN L/P</p>	 <p>TE Part # 170364-1 MINI UNIVERSAL M-N-L PIN LP</p>	 <p>TE Part # 1-770902-1 MINI UMNL SOK 26-22 AWG AU LF</p>

Also in the Series | **Mini-Universal MATE-N-LOK**

 <p>Connector Caps &amp; Covers(2)</p>	 <p>Connector Contacts(89)</p>	 <p>Connector Hardware(4)</p>	 <p>Connector Seals &amp; Cavity Plugs(17)</p>
---	--	--	---





Connector Strain Relief(2)



Insertion & Extraction Tools(1)



Rectangular Power Connectors(197)

## Customers Also Bought



TE Part # 172162-1  
12 CIR UNIV M-N-L CAP



TE Part # 172163-1  
15 CIR UNIV M-N-L CAP



TE Part # 172157-1  
2CIR MINI U-M-N-L CAP NATL

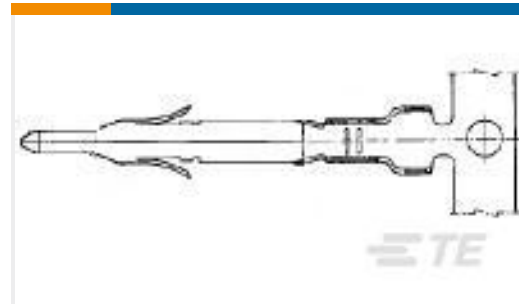

TE Part # 170363-1  
MINI UNIVERSAL M-N-L PIN LP



TE Part # 172161-1  
9 CIR UNIV M-N-L CAP

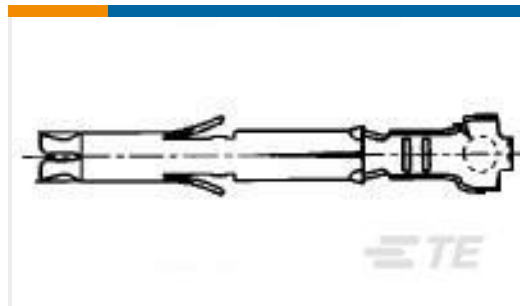

TE Part # 170365-1  
MINI UNIVERSAL M-N-L SOCKET LP



TE Part # 172169-1  
9 CIR UNIV M-N-L PLUG



TE Part # 172166-1  
3 CIR UNIV M-N-L PLUG



TE Part # 172165-1  
2 CIR UNIV M-N-L PLUG NATL



TE Part # 172168-1  
6 CIR UNIV M-N-L PLUG

## Documents

### Product Drawings

[4 CIR UNIV M-N-L CAP](#)

English

### CAD Files

[3D PDF](#)

3D

### Customer View Model

[ENG\\_CVM\\_CVM\\_172159-1\\_M.2d\\_dxf.zip](#)



English

**Customer View Model**

[ENG\\_CVM\\_CVM\\_172159-1\\_M.3d\\_igs.zip](#)

English

**Customer View Model**

[ENG\\_CVM\\_CVM\\_172159-1\\_M.3d\\_stp.zip](#)

English

By downloading the CAD file I accept and agree to the [Terms and Conditions](#) of use.

---

**Datasheets & Catalog Pages**

[SOFT\\_SHELL\\_PIN\\_AND\\_SOCKET\\_CONNECTORS\\_CATALOG](#)

English

---

**Product Specifications**

[Engineering Report](#)

English

---

**Instruction Sheets**

[Instruction Sheet \(U.S.\)](#)

English

---

**Agency Approvals**

[Agency Approval Document](#)

English