

320773 ✓ ACTIVE



PIDG

TE Internal #: 320773

Closed Ring Tongue Terminal, 22 - 16 AWG, M2 / #2 Stud Size, 2.18 mm [.086 in] Stud Diameter, Closed Barrel, Straight, Tin, Partially Insulated, PIDG

[View on TE.com >](#)

Terminals & Splices > Ring Terminals > PIDG Ring Tongue Terminals

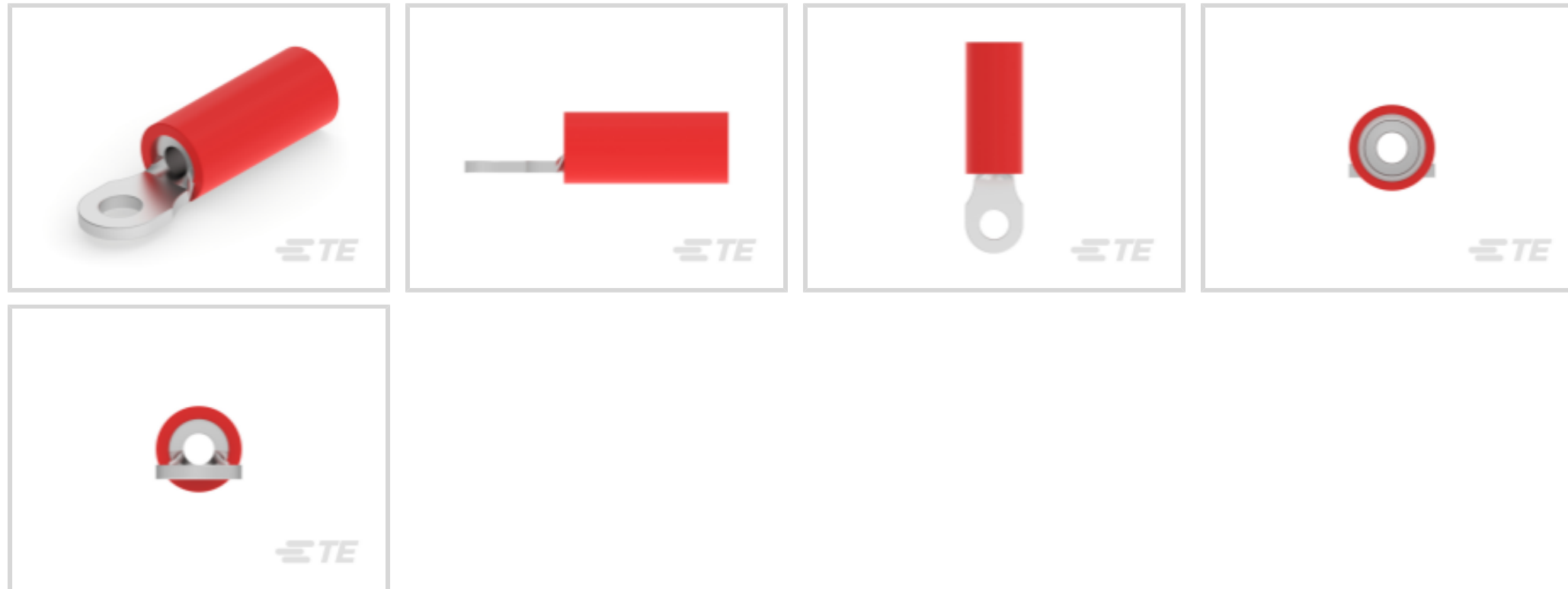

Ring Terminal Product Type: Closed Ring Tongue Terminal

Wire Size: 509 - 3260 CMA

Stud Size: #2, M2

[All PIDG Ring Tongue Terminals \(411\)](#)

Features

Product Type Features

Ring Terminal Product Type	Closed Ring Tongue Terminal
Stud Size	#2, M2
Sealable	No
Wire Insulation Support Retention Type	Insulation Support

Configuration Features

Number of Holes	1
-----------------	---

Body Features

Product Weight	.581 g
----------------	--------

Contact Features

Barrel Type	Closed
Terminal Orientation	Straight
Terminal Plating Material	Tin

Mechanical Attachment

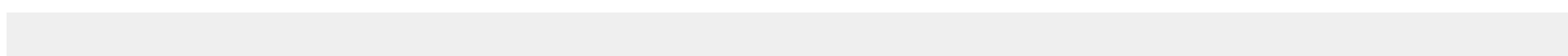



Wire Insulation Support	With
-------------------------	------

### Dimensions

Wire Size	509 - 3260 CMA
Stud Diameter	2.18 mm [.086 in]
Tongue Thickness	.79 mm [.031 in]
Product Length	16.99 mm [.669 in]
Compatible Insulation Diameter (Max)	3.56 mm [.14 in]
Compatible Insulation Diameter Range	2.67 - 3.56 mm [.105 - .14 in]

### Usage Conditions

Insulation Option	Partially Insulated
Operating Temperature Range	105 °C [221 °F]

### Operation/Application

Compatible With Wire Base Material	Copper
Compatible With Wire Plating Material	Tin

### Industry Standards

Government Qualified Terminal	No
-------------------------------	----

### Packaging Features

Packaging Quantity	1000
Packaging Method	Loose Piece

### Product Compliance











[For compliance documentation, visit the product page on TE.com>](#)

EU RoHS Directive 2011/65/EU	Compliant
EU ELV Directive 2000/53/EC	Compliant
China RoHS 2 Directive MIIT Order No 32, 2016	No Restricted Materials Above Threshold
EU REACH Regulation (EC) No. 1907/2006	Current ECHA Candidate List: JAN 2024 (240) Candidate List Declared Against: JAN 2024 (240) Does not contain REACH SVHC
Halogen Content	Low Halogen - Br, Cl, F, I < 900 ppm per homogenous material. Also BFR/CFR/PVC Free
Solder Process Capability	Not applicable for solder process capability

## Product Compliance Disclaimer

This information is provided based on reasonable inquiry of our suppliers and represents our current actual knowledge based on the information they provided. This information is subject to change. The part numbers that TE has identified as EU RoHS compliant have a maximum concentration of 0.1% by weight in homogenous materials for lead, hexavalent chromium, mercury, PBB, PBDE, DBP, BBP, DEHP, DIBP, and 0.01% for cadmium, or qualify for an exemption to these limits as defined in the Annexes of Directive 2011/65/EU (RoHS2). Finished electrical and electronic equipment products will be CE marked as required by Directive 2011/65/EU. Components may not be CE marked. Additionally, the part numbers that TE has identified as EU ELV compliant have a maximum concentration of 0.1% by weight in homogenous materials for lead, hexavalent chromium, and mercury, and 0.01% for cadmium, or qualify for an exemption to these limits as defined in the Annexes of Directive 2000/53/EC (ELV). Regarding the REACH Regulation, the information TE provides on SVHC in articles for this part number is based on the latest European Chemicals Agency (ECHA) 'Guidance on requirements for substances in articles' posted at this URL: <https://echa.europa.eu/guidance-documents/guidance-on-reach>

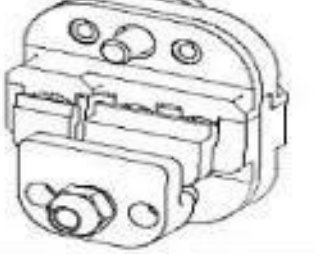
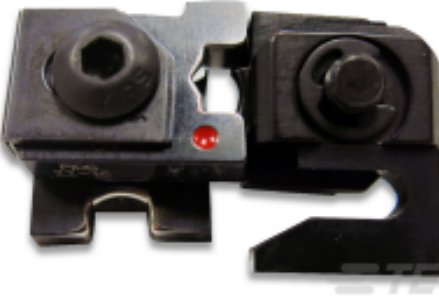
## Compatible Parts

 <p>TE Part # 59824-1 TETRA-CRIMP PIDG PG FASTON 22-10 ASSY</p>	 <p>TE Part # 47386 DAHT PG PIDG 26-16 ASSY</p>	 <p>TE Part # 47386-4 DAHT PG PIDG 26-16 ASSY</p>	 <p>TE Part # 58433-3 PRO CR ASSY, RBY IS9252</p>
 <p>TE Part # 59250 T-HEAD PIDG 26-14 ASSY</p>	 <p>TE Part # 58423-1 DIE, RBY IS9252</p>	 <p>TE Part # 525690 DAHT PG PIDG 20-18 ASSY</p>	 <p>TE Part # 539691-2 ERGO DIE R.B.Y</p>
 <p>TE Part # 55823-1 RBY PRO CRIMPER KIT</p>	 <p>TE Part # 2063030-1 SDE DIESET, RBY, UL</p>	 <p>TE Part # 47806-2 DIES PIDG 22-16 DIE SET</p>	 <p>TE Part # 59300 T-HEAD PIDG PG 26-16 ASSY</p>

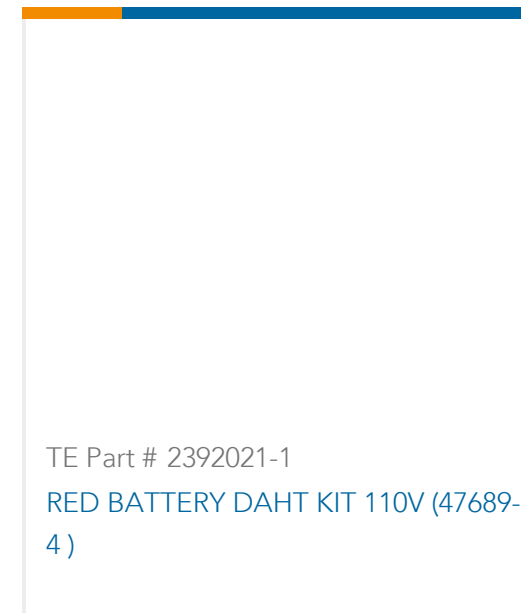
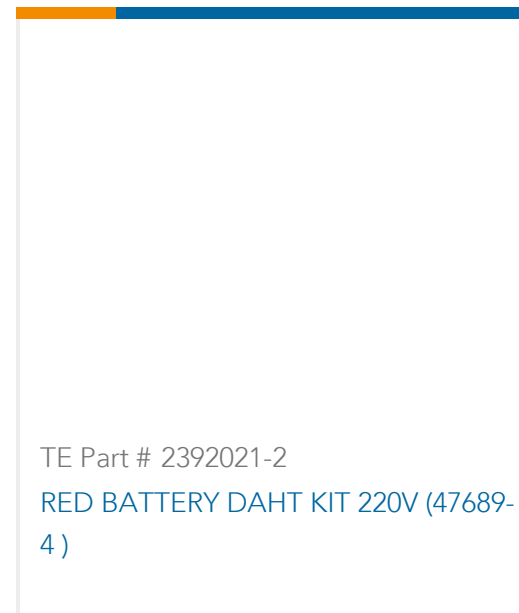

Also in the Series | PIDG

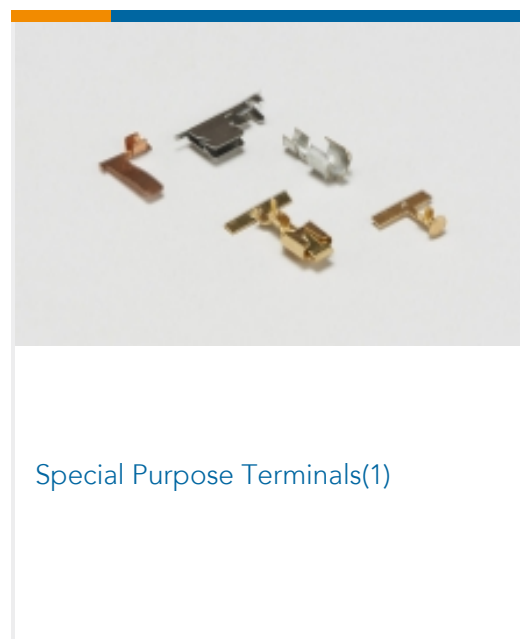
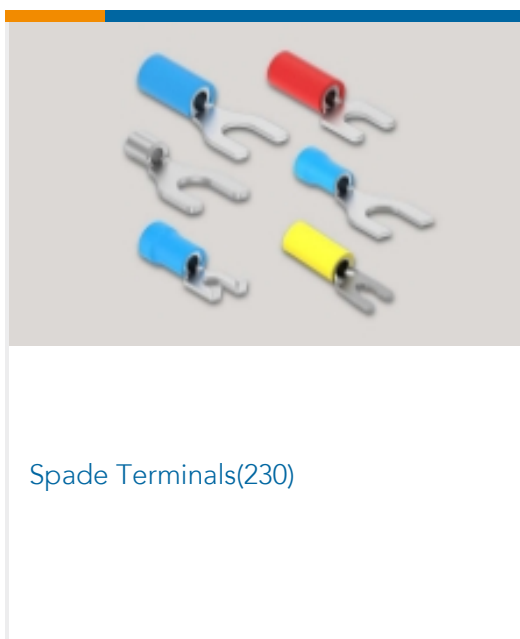
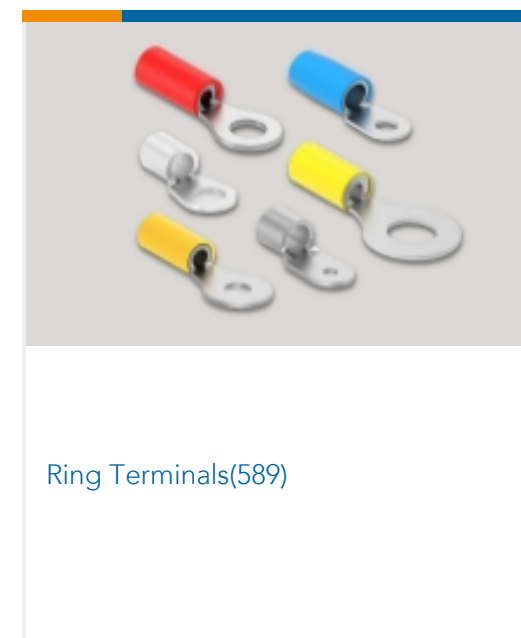
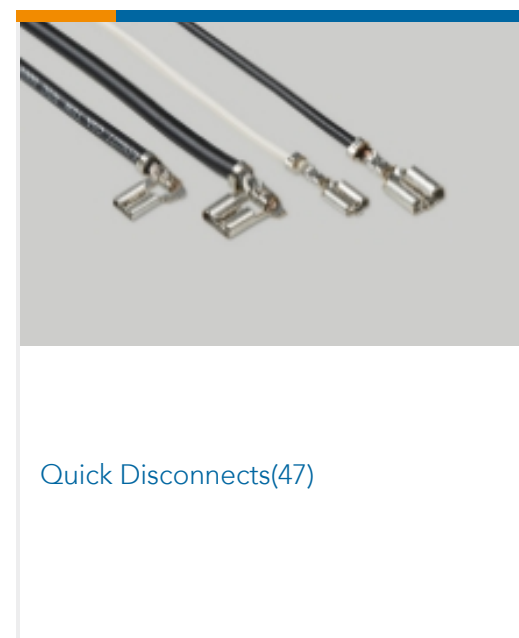
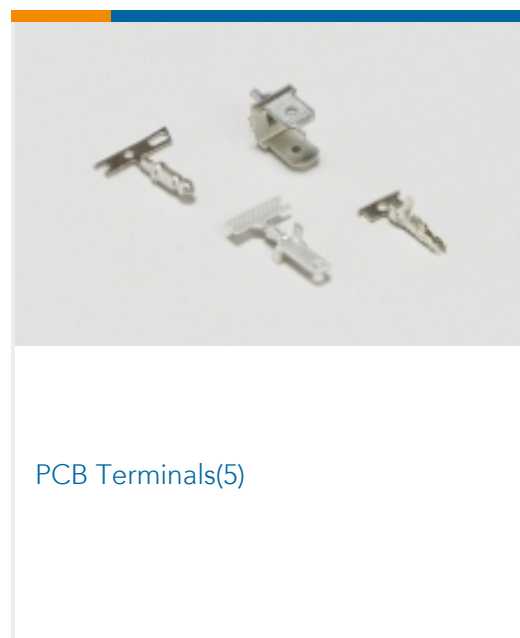
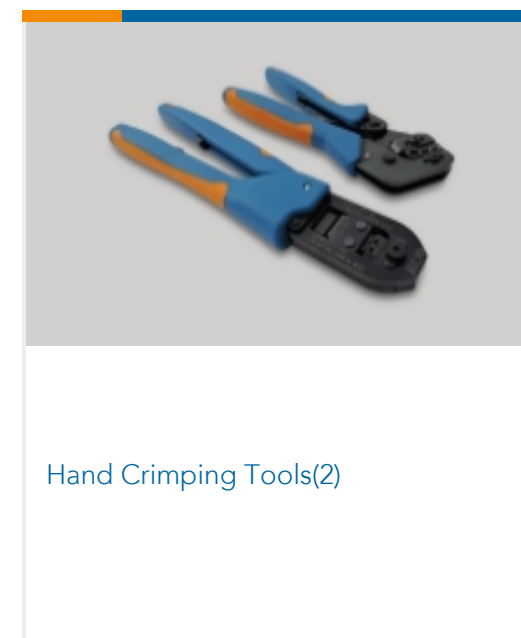
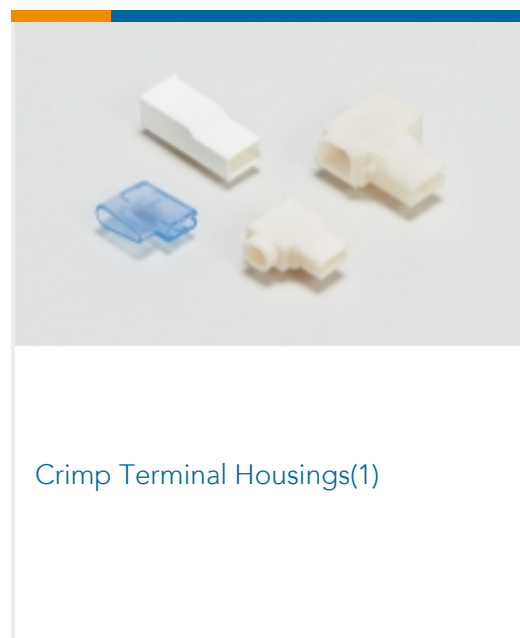
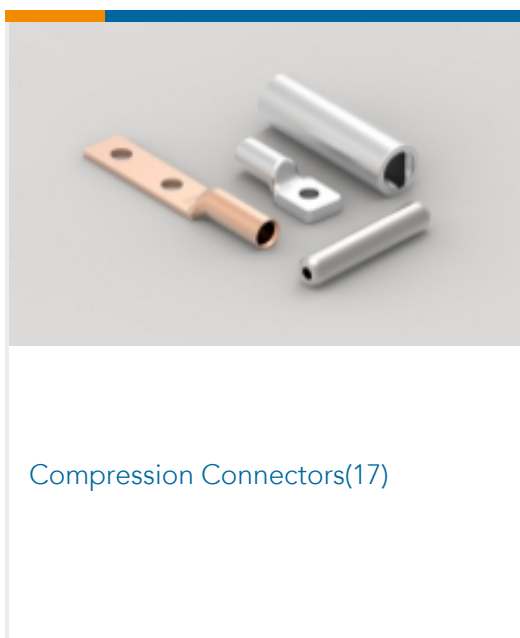

Customers Also Bought

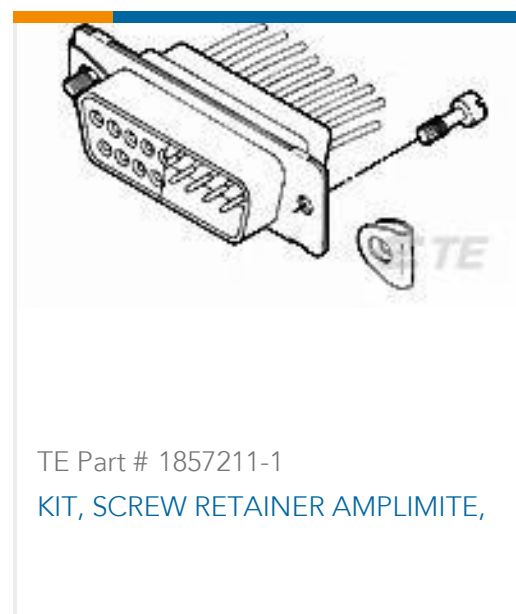

## Documents

### Product Drawings

[PIDG R 22-16 COMM 22-18 MIL 2](#)

English

### CAD Files

[3D PDF](#)

3D

Customer View Model

[ENG\\_CVM\\_CVM\\_320773\\_P.2d\\_dxf.zip](#)

English

Customer View Model

[ENG\\_CVM\\_CVM\\_320773\\_P.3d\\_igs.zip](#)

English

Customer View Model

[ENG\\_CVM\\_CVM\\_320773\\_P.3d\\_stp.zip](#)

English

By downloading the CAD file I accept and agree to the [Terms and Conditions](#) of use.

### Agency Approvals

320773

Closed Ring Tongue Terminal, 22 - 16 AWG, M2 / #2 Stud Size, 2.18 mm [.086 in] Stud Diameter, Closed Barrel, Straight, Tin, Partially Insulated, PIDG



## UL Report

English