

5223957-3 ✓ ACTIVE

Z-PACK 2mm HM

TE Internal #: 5223957-3

Guide Socket Module, Zinc Alloy Die Casting, Z-PACK 2mm HM

[View on TE.com >](#)



Connectors > Connector Accessories > Connector Hardware

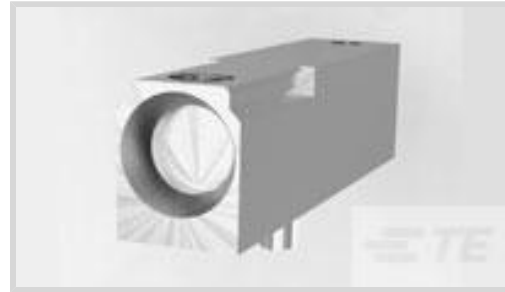

Hardware Accessory Function: **Guide Hardware**

Connector Hardware Accessory Type: **Guide Socket Module**

Primary Product Material: **Zinc Alloy Die Casting**

Features

Product Type Features

Hardware Accessory Function	Guide Hardware
Connector Hardware Accessory Type	Guide Socket Module

Body Features

Product Orientation	Right Angle
Primary Product Material	Zinc Alloy Die Casting

Mechanical Attachment

Product Plating Finish	Chromate Conversion Coating
Thread Size	M3 x 0.5

Dimensions

Product Length	34.2 mm
----------------	---------

Packaging Features

Packaging Quantity	1
Packaging Method	Box

Product Compliance

[For compliance documentation, visit the product page on TE.com>](#)

EU RoHS Directive 2011/65/EU	Compliant
EU ELV Directive 2000/53/EC	Compliant
China RoHS 2 Directive MIIT Order No 32, 2016	No Restricted Materials Above Threshold
EU REACH Regulation (EC) No. 1907/2006	Current ECHA Candidate List: JAN 2024 (240)

Candidate List Declared Against: JAN 2024
(240)

Does not contain REACH SVHC

Halogen Content

Low Halogen - Br, Cl, F, I < 900 ppm per homogenous material. Also BFR/CFR/PVC Free

Solder Process Capability

Not applicable for solder process capability

Product Compliance Disclaimer

This information is provided based on reasonable inquiry of our suppliers and represents our current actual knowledge based on the information they provided. This information is subject to change. The part numbers that TE has identified as EU RoHS compliant have a maximum concentration of 0.1% by weight in homogenous materials for lead, hexavalent chromium, mercury, PBB, PBDE, DBP, BBP, DEHP, DIBP, and 0.01% for cadmium, or qualify for an exemption to these limits as defined in the Annexes of Directive 2011/65/EU (RoHS2). Finished electrical and electronic equipment products will be CE marked as required by Directive 2011/65/EU. Components may not be CE marked. Additionally, the part numbers that TE has identified as EU ELV compliant have a maximum concentration of 0.1% by weight in homogenous materials for lead, hexavalent chromium, and mercury, and 0.01% for cadmium, or qualify for an exemption to these limits as defined in the Annexes of Directive 2000/53/EC (ELV). Regarding the REACH Regulation, the information TE provides on SVHC in articles for this part number is based on the latest European Chemicals Agency (ECHA) 'Guidance on requirements for substances in articles' posted at this URL: <https://echa.europa.eu/guidance-documents/guidance-on-reach>

Compatible Parts



TE Part # 223969-7
UNV PWR MDL, GUIDE PIN LOCT PL



TE Part # 223956-1
STV ERMZUB FUEHRUNGSBOLZEN J
*M 1 ***



TE Part # 223969-4
UNV PWR MDL, GUIDE PIN LOCT PL



TE Part # 120985-1
UNV PWR MDL, GUIDE PIN PLTD



TE Part # 223988-1
UNV PWR MDL, GUIDE PIN PLTD



TE Part # 5223985-5
UPM KEYED GUIDE PIN #6-32



TE Part # 5223985-1
UPM KEYED GUIDE PIN



TE Part # 223982-1
Stainless Steel Guide Pin M4x0.7



TE Part # 5223985-9
UPM KEYED GUIDE PIN



TE Part # 5223985-6
UPM KEYED GUIDE PIN #6-32



TE Part # 1469265-9
UPM R/A GUIDE PIN



TE Part # 5223985-4
UPM KEYED GUIDE PIN, #6-32



TE Part # 5223985-7
UPM KEYED GUIDE PIN



TE Part # 5223985-8
UPM KEYED GUIDE PIN



TE Part # 223969-1
UNV PWR MDL, GUIDE PIN LOCT PL



TE Part # 1857988-1
Z-PACK UHD GUIDE PIN



TE Part # 5223985-3
UPM KEYED GUIDE PIN

Also in the Series | **Z-PACK 2mm HM**

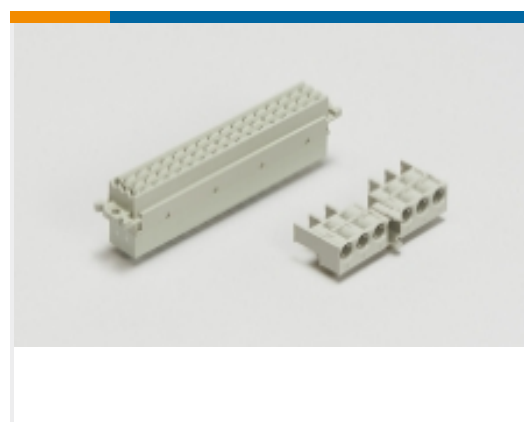

Backplane Connector Housings(4)



Backplane Power Connectors(6)

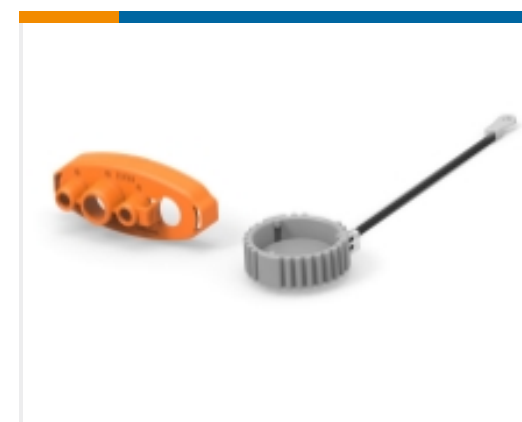

Connector Caps & Covers(62)

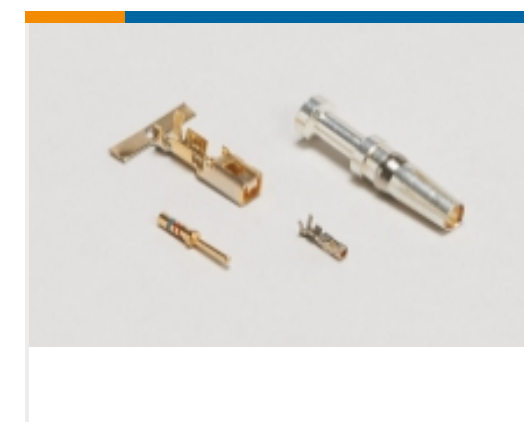

Connector Contacts(2)



Connector Hardware(97)

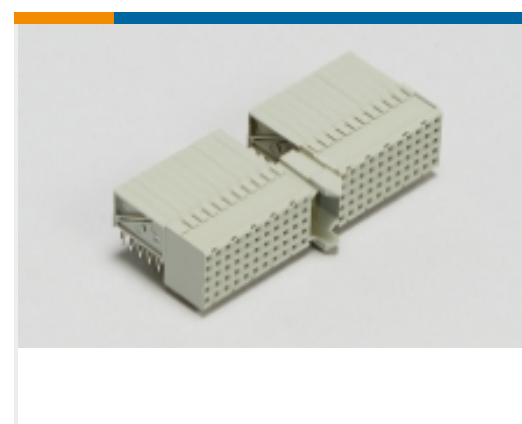

Hard Metric Backplane Connectors (267)



High Speed Backplane Connectors(1)



Insertion & Extraction Tools(2)



Rectangular Power Connectors(87)

Customers Also Bought

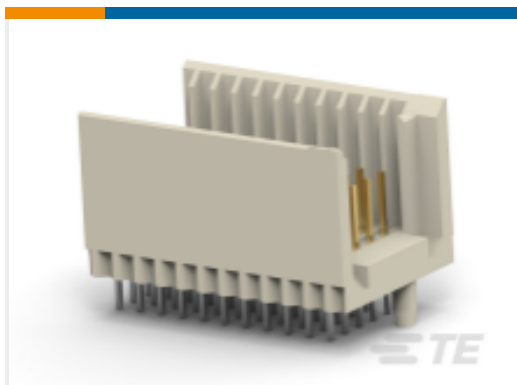

TE Part # 5646529-1
Hard Metric Male Connector:
Traditional Backplane, Mezzanine,
2mm



TE Part # 5646547-1
Z-PACK A-B 25 COLUMN SHLD ASSY



TE Part # 3-1879021-5
SMW3 2R7 5%



TE Part # 5-5223961-1
TE UPM R/A Header 3P HC Power, LLL

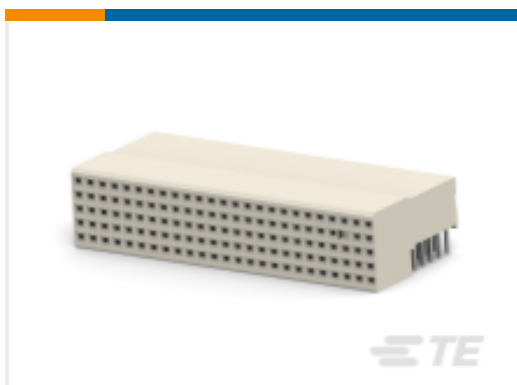

TE Part # 1857990-1
Z-PACK/B F-HDR.125P, EON

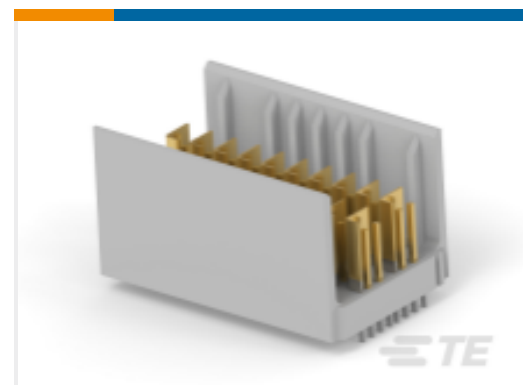

TE Part # 2170328-1
HMZD+, 2PAIRS, 10COLS, VERTICAL,
ASSEMBLY



TE Part # 1-1123724-3
3.96EP HDR ASSY 3(5)P NATURAL



TE Part # 2822650-1
MP456P HD Receptacle Connector

Documents

Product Drawings

UPM GUIDE MODULE

English

CAD Files

Customer View Model

[ENG_CVM_CVM_5223957-3_A.2d_dxf.zip](#)

English

3D PDF

3D

Customer View Model

[ENG_CVM_CVM_5223957-3_A.3d_igs.zip](#)

English

Customer View Model

[ENG_CVM_CVM_5223957-3_A.3d_stp.zip](#)

English

By downloading the CAD file I accept and agree to the [Terms and Conditions](#) of use.



Datasheets & Catalog Pages

[2_PIECE_POWER_CONNECTORS_qrg_4-1773458-1](#)

English

Product Specifications

[Engineering Report](#)

English