

BARBARA-WW-PF

~60° wide beam

SPECIFICATION:

Dimensions	Ø 70.0 mm
Height	41.7 mm
Fastening	socket
ROHS compliant	yes ⓘ

MATERIALS:

Component	Type	Material	Colour	Finish	Coating
BARBARA-WW-PF	Reflector	PC	metal		HMDS



ORDERING INFORMATION:

Component	Qty in box	MOQ	MPQ	Box weight (kg)
F13702_BARBARA-WW-PF » Box size: 480 x 280 x 300 mm	288	90	18	5.8

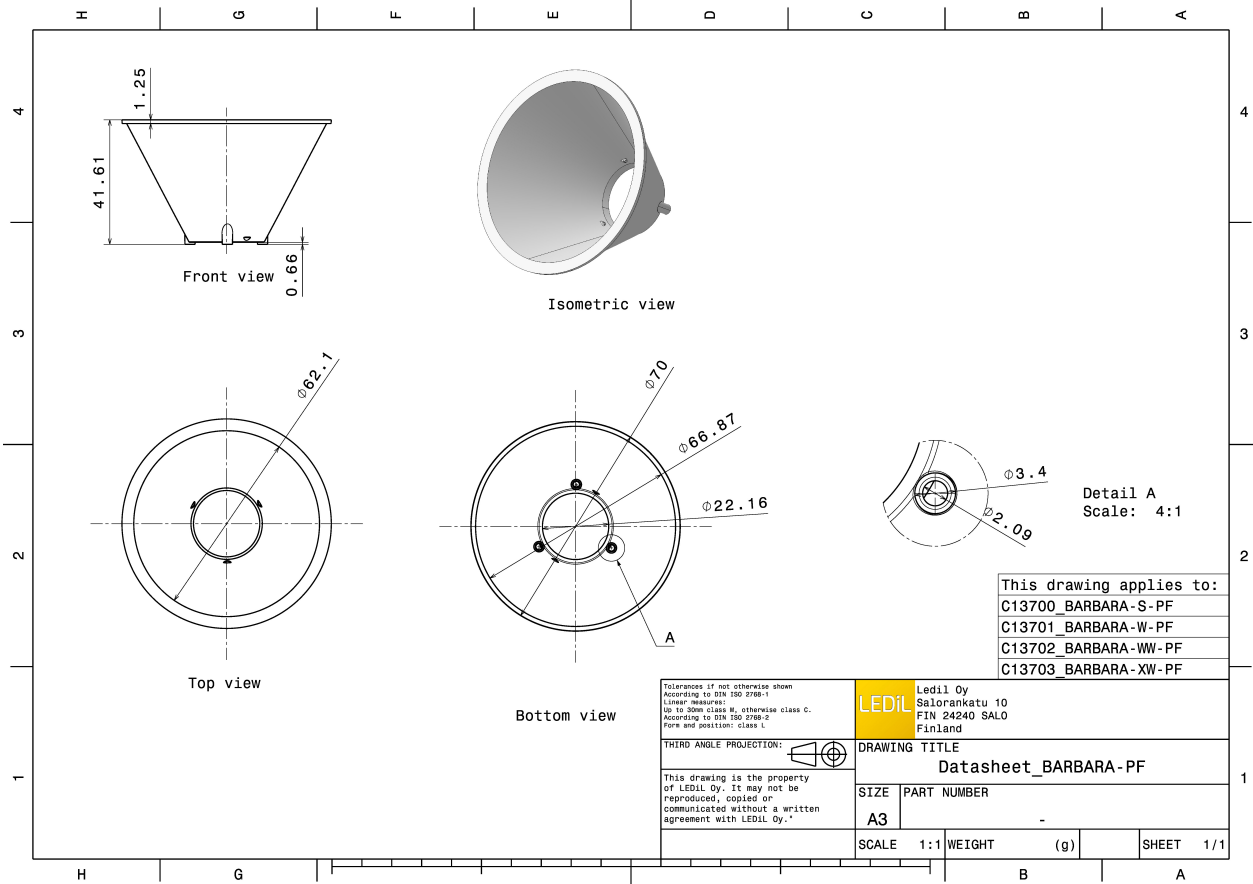

See also our general installation guide: www.ledil.com/installation_guide

OPTICAL RESULTS (MEASURED):

bridgelux

LED V10 Gen7
FWHM / FWTM 44.0° / 74.0°
Efficiency 88 %
Peak intensity 1.6 cd/lm
LEDs/each optic 1
Light colour/type White

Required components:

C13709_PF-SOCKET-VERO13-18

Bender Wirth: 434 Typ L1

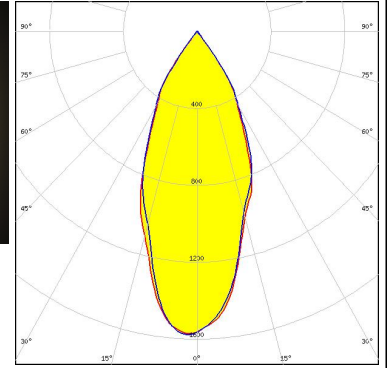

Light distribution files

bridgelux

LED V15 Gen6
FWHM / FWTM 51.0° / 78.0°
Efficiency 86 %
Peak intensity 1.4 cd/lm
LEDs/each optic 1
Light colour/type White

Required components:

C13709_PF-SOCKET-VERO13-18

Bender Wirth: 456 Typ L2

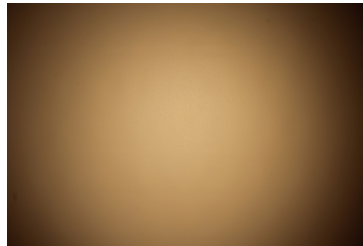

Light distribution files

bridgelux

LED VERO10
FWHM / FWTM 49.0° / 77.0°
Efficiency 89 %
Peak intensity 1.5 cd/lm
LEDs/each optic 1
Light colour/type White

Required components:

C13708_PF-SOCKET-VERO10

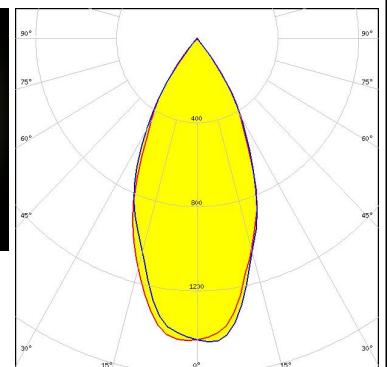
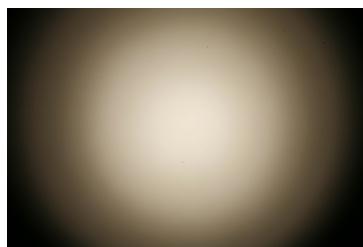

Light distribution files

OPTICAL RESULTS (MEASURED):



LED VERO13
FWHM / FWTM 51.0° / 77.0°
Efficiency 90 %
Peak intensity 1.4 cd/lm
LEDs/each optic 1
Light colour/type White
Required components:
 C13709_PF-SOCKET-VERO13-18

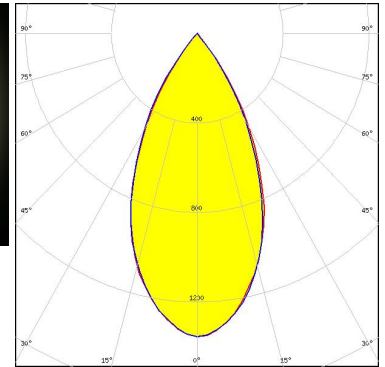
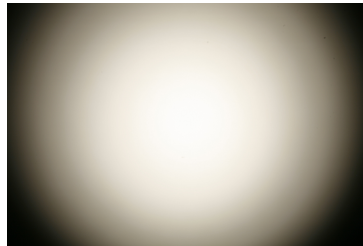

Light distribution files



LED VERO18
FWHM / FWTM 58.0° / 83.0°
Efficiency 91 %
Peak intensity 1.2 cd/lm
LEDs/each optic 1
Light colour/type White
Required components:
 C13709_PF-SOCKET-VERO13-18

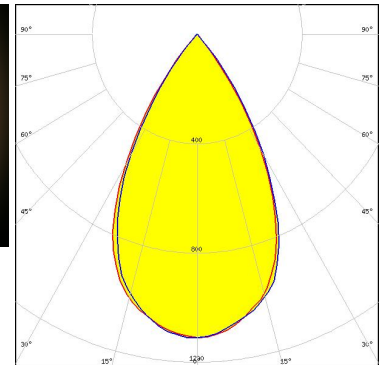
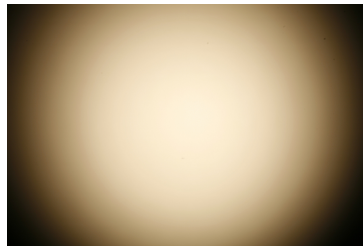

Light distribution files



LED Xenio Point 13mm
FWHM / FWTM 49.0° / 76.0°
Efficiency 89 %
Peak intensity 1.4 cd/lm
LEDs/each optic 1
Light colour/type White
Required components:
 C13709_PF-SOCKET-VERO13-18

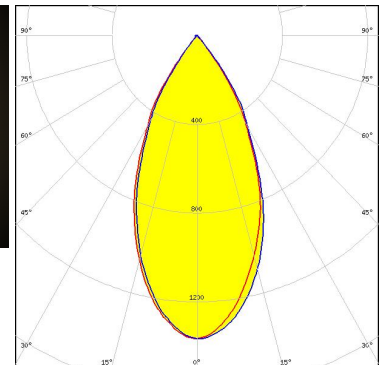
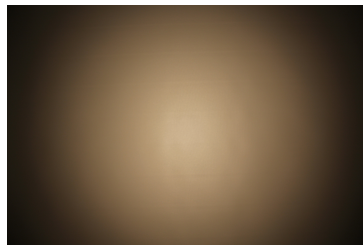

Light distribution files

OPTICAL RESULTS (MEASURED):



LED Xenio Point 18mm
 FWHM / FWTM 59.0° / 80.0°
 Efficiency 88 %
 Peak intensity 1.1 cd/lm
 LEDs/each optic 1
 Light colour/type White
 Required components:
 C13709_PF-SOCKET-VERO13-18

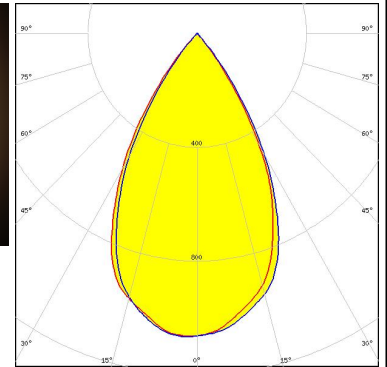
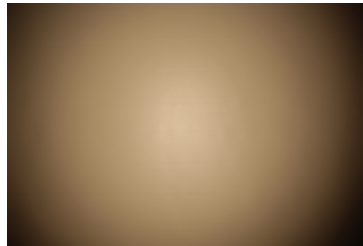

Light distribution files

CITIZEN

LED CLL02x/CLU02x (LES10)
 FWHM / FWTM 43.0° / 74.0°
 Efficiency 88 %
 Peak intensity 1.6 cd/lm
 LEDs/each optic 1
 Light colour/type White
 Required components:
 C13709_PF-SOCKET-VERO13-18
 Bender Wirth: 434 Typ L1

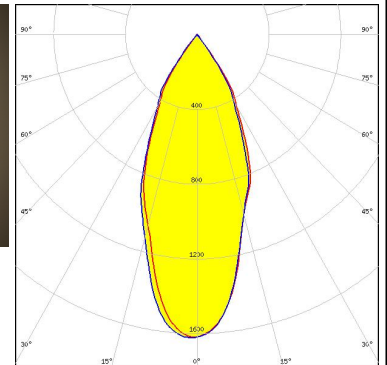
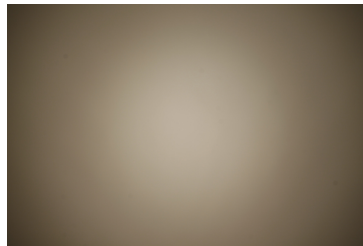

Light distribution files

CITIZEN

LED CLL03x/CLU03x
 FWHM / FWTM 50.0° / 76.0°
 Efficiency 86 %
 Peak intensity 1.3 cd/lm
 LEDs/each optic 1
 Light colour/type White
 Required components:
 C13709_PF-SOCKET-VERO13-18
 Bender Wirth: 433 Typ L1

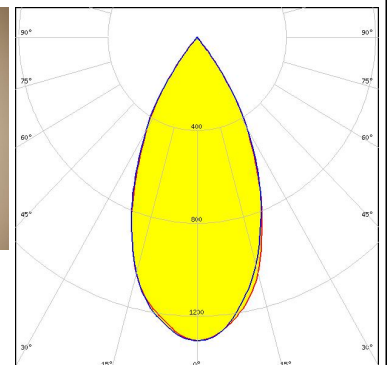
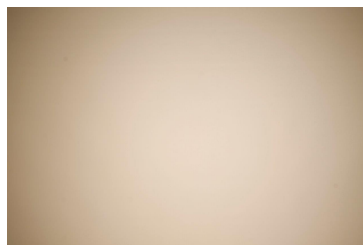

Light distribution files

OPTICAL RESULTS (MEASURED):

CITIZEN

LED CLU700/701/702/703
FWHM / FWTM 28.0° / 72.0°
Efficiency 88 %
Peak intensity 2.1 cd/lm
LEDs/each optic 1
Light colour/type White
Required components:
C13709_PF-SOCKET-VERO13-18
Bender Wirth: 434 Typ L1

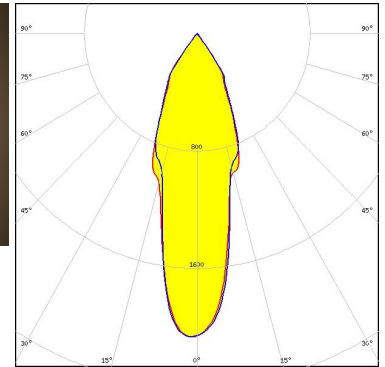
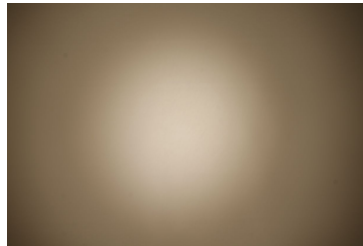

Light distribution files

CITIZEN

LED CLU720/721/723
FWHM / FWTM 43.0° / 73.0°
Efficiency 86 %
LEDs/each optic 1
Light colour/type White
Required components:
C13709_PF-SOCKET-VERO13-18
Bender Wirth: 433 Typ L1

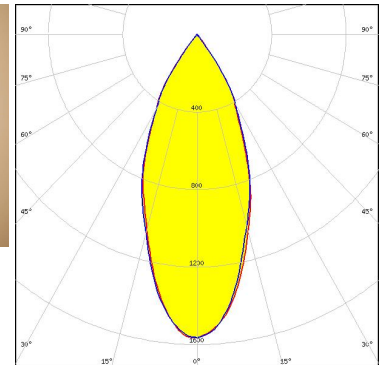
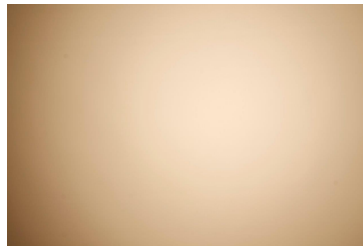

Light distribution files



LED CXA/B 15xx
FWHM / FWTM 41.0° / 73.0°
Efficiency 87 %
Peak intensity 1.7 cd/lm
LEDs/each optic 1
Light colour/type White
Required components:
C13709_PF-SOCKET-VERO13-18
Bender Wirth: 441 Typ L1

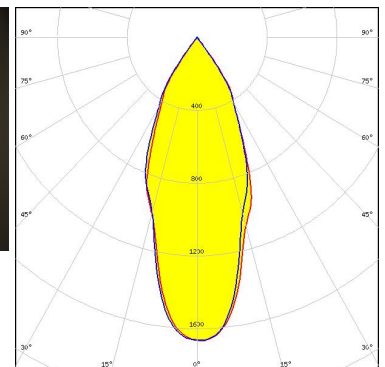
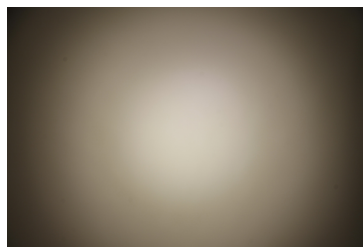

Light distribution files

OPTICAL RESULTS (MEASURED):



LED CXA/B 15xx
 FWHM / FWTM 51.0° / 78.0°
 Efficiency 85 %
 Peak intensity 1.2 cd/lm
 LEDs/each optic 1
 Light colour/type White
 Required components:
 C13083_PF-SOCKET
 C14658_BARBARA-RZ-LENS

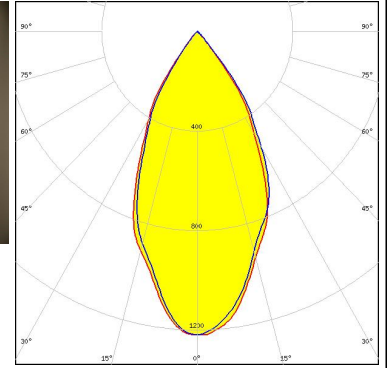

Light distribution files



LED CXA/B 15xx
 FWHM / FWTM 40.0° / 73.0°
 Efficiency 89 %
 Peak intensity 1.8 cd/lm
 LEDs/each optic 1
 Light colour/type White
 Required components:
 C14115_PF-SOCKET-CXA15-18

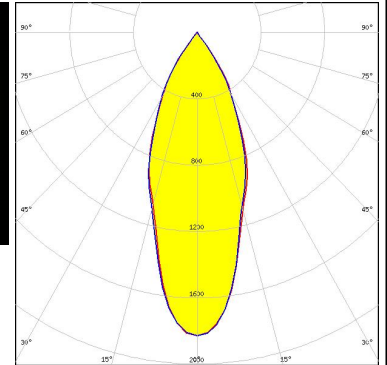
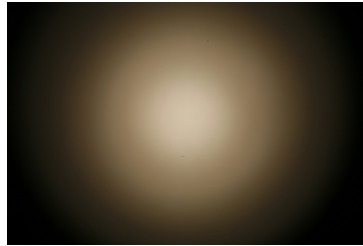

Light distribution files



LED CXA/B 1816 & CXA/B 1820 & CXA 1850
 FWHM / FWTM 46.0° / 75.0°
 Efficiency 90 %
 Peak intensity 1.6 cd/lm
 LEDs/each optic 1
 Light colour/type White
 Required components:
 C14115_PF-SOCKET-CXA15-18

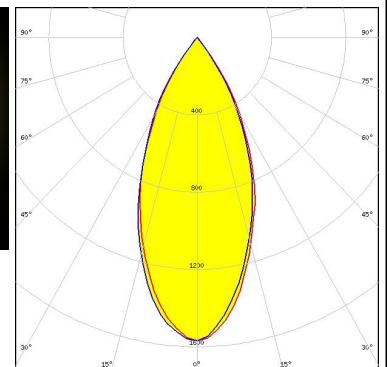
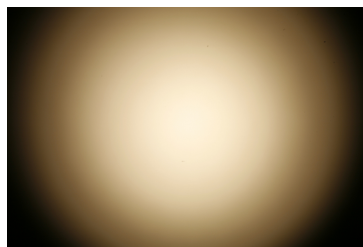

Light distribution files

OPTICAL RESULTS (MEASURED):



LED CXA/B 1816 & CXA/B 1820 & CXA 1850
FWHM / FWTM 46.0° / 75.0°
Efficiency 86 %
Peak intensity 1.4 cd/lm
LEDs/each optic 1
Light colour/type White
Required components:
 C13709_PF-SOCKET-VERO13-18
 Bender Wirth: 437 Typ L1

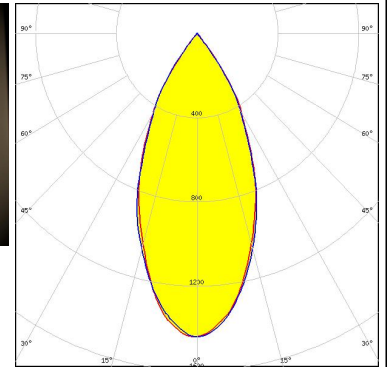
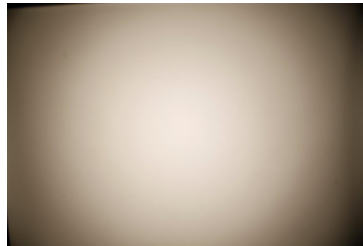

Light distribution files



LED LUXEON CoB 1202/1203
FWHM / FWTM 39.0° / 73.0°
Efficiency 88 %
Peak intensity 1.7 cd/lm
LEDs/each optic 1
Light colour/type White
Required components:
 C13709_PF-SOCKET-VERO13-18
 Bender Wirth: 438 Typ L1

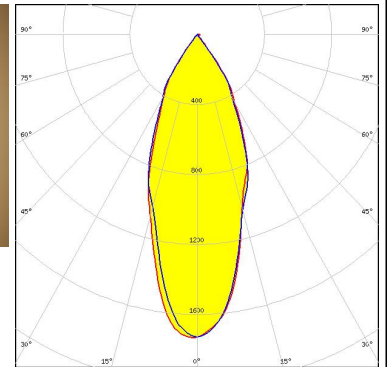
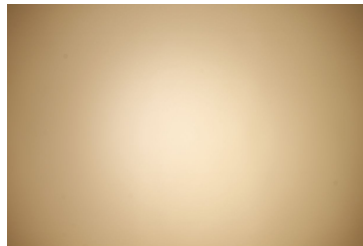

Light distribution files



LED COB J-Type
FWHM / FWTM 51.0° / 76.0°
Efficiency 86 %
Peak intensity 1.3 cd/lm
LEDs/each optic 1
Light colour/type White
Required components:
 C13709_PF-SOCKET-VERO13-18
 Bender Wirth: 463 Typ L2

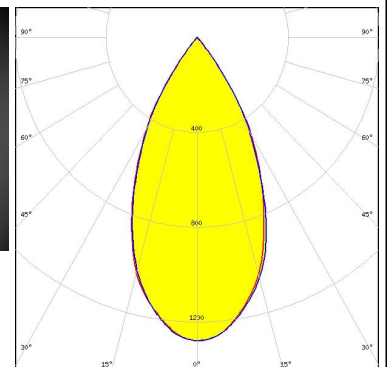
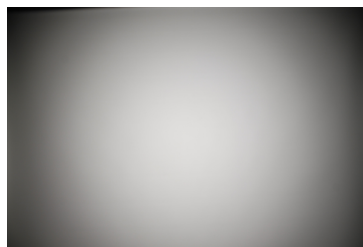

Light distribution files

OPTICAL RESULTS (MEASURED):



LED COB J-Type
FWHM / FWTM 55.0° / 78.0°
Efficiency 90 %
Peak intensity 1.2 cd/lm
LEDs/each optic 1
Light colour/type White
Required components:
 C14037_PF-NSX-SOCKET

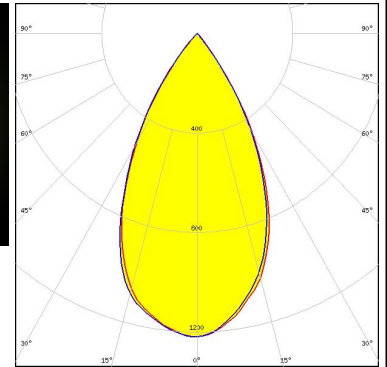

Light distribution files



LED COB L-Type (LES 11)
FWHM / FWTM 51.0° / 77.0°
Efficiency 90 %
Peak intensity 1.3 cd/lm
LEDs/each optic 1
Light colour/type White
Required components:
 C14037_PF-NSX-SOCKET

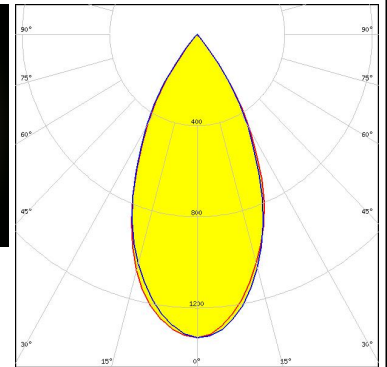

Light distribution files



LED COB L-Type (LES 11)
FWHM / FWTM 46.0° / 75.0°
Efficiency 87 %
Peak intensity 1.5 cd/lm
LEDs/each optic 1
Light colour/type White
Required components:
 C13709_PF-SOCKET-VERO13-18
 Bender Wirth: 438 Typ L1

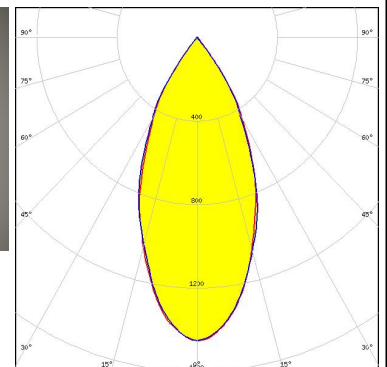

Light distribution files

OPTICAL RESULTS (MEASURED):



LED COB L-Type (LES 9)
FWHM / FWTM 47.0° / 76.0°
Efficiency 91 %
Peak intensity 1.5 cd/lm
LEDs/each optic 1
Light colour/type White
Required components:
C14037_PF-NSX-SOCKET

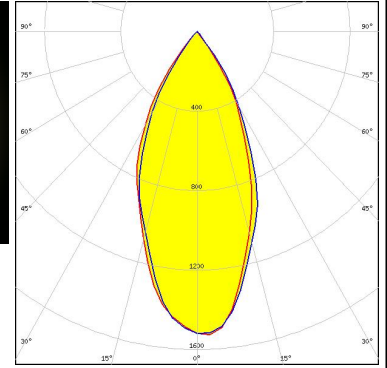

Light distribution files



LED COB L-Type (LES 9)
FWHM / FWTM 41.0° / 74.0°
Efficiency 89 %
Peak intensity 1.7 cd/lm
LEDs/each optic 1
Light colour/type White
Required components:
C13709_PF-SOCKET-VERO13-18
Bender Wirth: 438 Typ L1

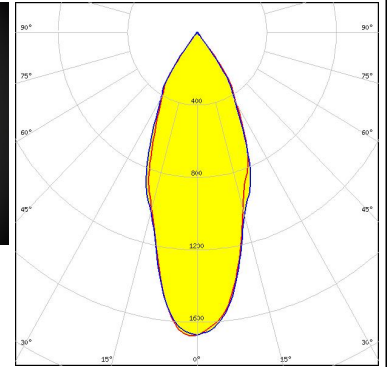

Light distribution files



LED Soleriq S13
FWHM / FWTM 47.0° / 75.0°
Efficiency 87 %
Peak intensity 1.4 cd/lm
LEDs/each optic 1
Light colour/type White
Required components:
C13709_PF-SOCKET-VERO13-18
Bender Wirth: 437 Typ L1

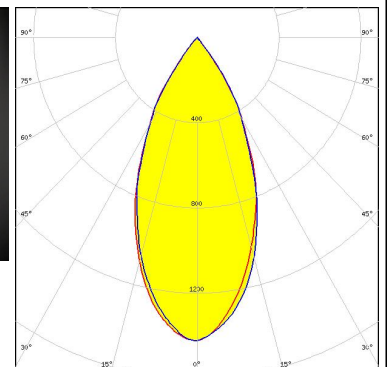
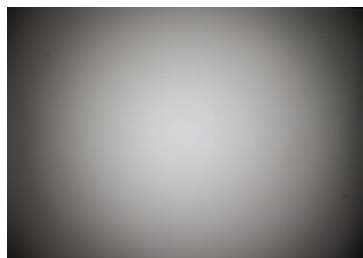

Light distribution files

OPTICAL RESULTS (MEASURED):

SAMSUNG

LED LC026B / 033B / 040B
 FWHM / FWTM 55.0° / 78.0°
 Efficiency 86 %
 Peak intensity 1.1 cd/lm
 LEDs/each optic 1
 Light colour/type White
 Required components:
 C13709_PF-SOCKET-VERO13-18
 Bender Wirth: 450 Typ L2

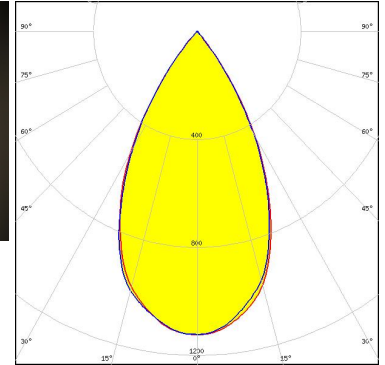

Light distribution files

XICATO

LED XTM - 19mm LES
 FWHM / FWTM 55.0° / 78.0°
 Efficiency 84 %
 Peak intensity 1.1 cd/lm
 LEDs/each optic 1
 Light colour/type White
 Required components:
 C14636_XTM-PF-ADAPTER

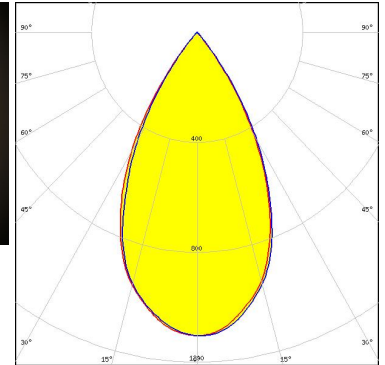
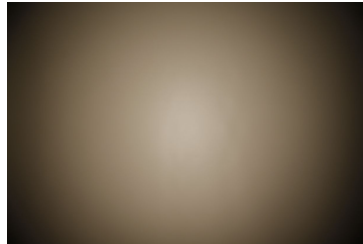

Light distribution files

XICATO

LED XTM - 9mm LES
 FWHM / FWTM 42.0° / 73.0°
 Efficiency 87 %
 Peak intensity 1.7 cd/lm
 LEDs/each optic 1
 Light colour/type White
 Required components:
 C14636_XTM-PF-ADAPTER

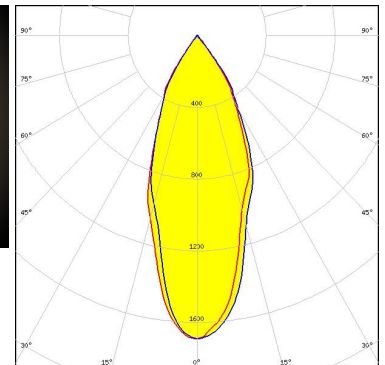
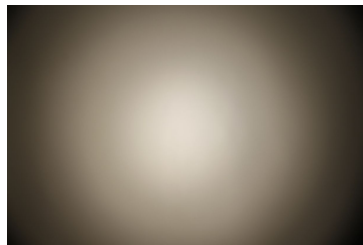

Light distribution files

OPTICAL RESULTS (SIMULATED):



LED VERO10
FWHM / FWTM 66.0°
Efficiency %
LEDs/each optic 1
Light colour/type White
Required components:

Light distribution files



LED VERO13
FWHM / FWTM 67.0°
Efficiency %
LEDs/each optic 1
Light colour/type White
Required components:

Light distribution files



LED VERO18
FWHM / FWTM 68.0°
Efficiency %
LEDs/each optic 1
Light colour/type White
Required components:

Light distribution files

OPTICAL RESULTS (SIMULATED):



LED CxM-14 (19x19)
FWHM / FWTM 50.0° / 76.0°
Efficiency 86 %
Peak intensity 1.3 cd/lm
LEDs/each optic 1
Light colour/type White

Required components:

C13709_PF-SOCKET-VERO13-18

Bender Wirth: 433 Typ L1

[Light distribution files](#)



LED CxM-9 (13.5x13.5)
FWHM / FWTM 43.0° / 74.0°
Efficiency 88 %
Peak intensity 1.6 cd/lm
LEDs/each optic 1
Light colour/type White

Required components:

C13709_PF-SOCKET-VERO13-18

Bender Wirth: 434 Typ L1

[Light distribution files](#)



LED Soleriq S15
FWHM / FWTM 73.0° / 88.0°
Efficiency 90 %
Peak intensity 0.8 cd/lm
LEDs/each optic 1
Light colour/type White

Required components:

C13709_PF-SOCKET-VERO13-18

Bender Wirth: 433 Typ L1

[Light distribution files](#)

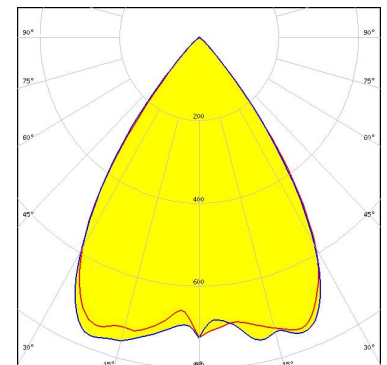

OPTICAL RESULTS (SIMULATED):

 SEOL SEMICONDUCTOR	
LED	ZC12/18
FWHM / FWTM	50.0° / 76.0°
Efficiency	86 %
Peak intensity	1.3 cd/lm
LEDs/each optic	1
Light colour/type	White
Required components: C13709_PF-SOCKET-VERO13-18	
Bender Wirth: 433 Typ L1	

 SEOL SEMICONDUCTOR	
LED	ZC4/6
FWHM / FWTM	43.0° / 74.0°
Efficiency	88 %
Peak intensity	1.6 cd/lm
LEDs/each optic	1
Light colour/type	White
Required components: C13709_PF-SOCKET-VERO13-18	
Bender Wirth: 434 Typ L1	

GENERAL INFORMATION:

NOTE: The typical beam angle will be changed by different color, chip size and chip position tolerance. The typical total beam angle is the full angle measured where the luminous intensity is half of the peak value.

Due to use of high power COB's with this product, special attention to proper thermal design is highly recommended. LEDiL has no liability for direct, indirect or consecutive damages arising from the LEDiL products being used outside of the recommended temperature range.

MATERIALS:

As part of our continuous research and improvement processes, and to ensure the best possible quality and availability of our products, LEDiL reserves the right to change material grades without notice.

PRODUCT DATA USER AGREEMENT AND DISCLAIMER:

The measured data in the provided downloadable LEDiL Product Datasheets and Mechanical 2D-Drawings is rounded and provided as reference for planning. LEDiL Oy's optical specifications have been verified by conducting performance testing of the products in accordance with the company's quality system. The reported data are averaged results of multiple measurements with typical variation. LEDiL Oy reserves the right to without prior notification make changes and improvements to its products.

LEDiL Oy assumes neither warranty, nor guarantee nor any other liability of any kind for the contents and correctness of the provided data. The provided data has been generated with highest diligence but the provided data may in reality not represent the complete possible variation range of all intrinsic parameters. Therefore, in certain cases a deviation from the provided data could occur.

LEDiL Oy reserves the right to undertake technical changes of its products without further notification which could lead to changes in the provided data. LEDiL Oy assumes no liability of any kind for the possible deviation from any provided data or any other damage resulting from the usage of the provided data.

The user agrees to this disclaimer and user agreement with the download or usage of the provided files.

LEDiL Oy

Joensuunkatu 13
FI-24240 SALO
Finland

LEDiL Inc.

228 West Page Street
Suite D
Sycamore IL 60178
USA

Ledil Optics Technology (Shenzhen) Co., Ltd.

405 , Block B
Casic Motor Building
Shenzhen 518057
P.R.CHINA

Local sales and technical support

[www.ledil.com/
where_to_buy](http://www.ledil.com/where_to_buy)

Shipping locations

Poznan, Poland
Hong Kong, China

Distribution Partners

[www.ledil.com/
where_to_buy](http://www.ledil.com/where_to_buy)