

MOSFET – Power, Single N-Channel

40 V, 2.4 mΩ, 136 A

NVTF5002N04C

Features

- Small Footprint (3.3 x 3.3 mm) for Compact Design
- Low R_{DS(on)} to Minimize Conduction Losses
- Low Capacitance to Minimize Driver Losses
- NVTF5002N04C – Wettable Flanks Product
- AEC-Q101 Qualified and PPAP Capable
- These Devices are Pb-Free and are RoHS Compliant

MAXIMUM RATINGS (T_J = 25°C unless otherwise noted)

Parameter	Symbol	Value	Unit
Drain-to-Source Voltage	V _{DSS}	40	V
Gate-to-Source Voltage	V _{GS}	±20	V
Continuous Drain Current R _{θJC} (Notes 1, 2, 3, 4)	Steady State	T _C = 25°C	I _D 136 A
		T _C = 100°C	77
Power Dissipation R _{θJC} (Notes 1, 2, 3)	Steady State	T _C = 25°C	P _D 85 W
		T _C = 100°C	27
Continuous Drain Current R _{θJA} (Notes 1, 3, 4)	Steady State	T _A = 25°C	I _D 27 A
		T _A = 100°C	19
Power Dissipation R _{θJA} (Notes 1, 3)	Steady State	T _A = 25°C	P _D 3.2 W
		T _A = 100°C	1.6
Pulsed Drain Current	T _A = 25°C, t _p = 10 μs	I _{DM} 676	A
Operating Junction and Storage Temperature Range	T _J , T _{stg}	-55 to +175	°C
Source Current (Body Diode)	I _S	70.4	A
Single Pulse Drain-to-Source Avalanche Energy (I _{L(pk)} = 10.2 A)	E _{AS}	268	mJ
Lead Temperature for Soldering Purposes (1/8" from case for 10 s)	T _L	260	°C

Stresses exceeding those listed in the Maximum Ratings table may damage the device. If any of these limits are exceeded, device functionality should not be assumed, damage may occur and reliability may be affected.

THERMAL RESISTANCE MAXIMUM RATINGS (Note 1)

Parameter	Symbol	Value	Unit
Junction-to-Case – Steady State (Note 3)	R _{θJC}	1.8	°C/W
Junction-to-Ambient – Steady State (Note 3)	R _{θJA}	46.5	

1. The entire application environment impacts the thermal resistance values shown, they are not constants and are only valid for the particular conditions noted.
2. Psi (Ψ) is used as required per JESD51-12 for packages in which substantially less than 100% of the heat flows to single case surface.
3. Surface-mounted on FR4 board using a 650 mm², 2 oz. Cu pad.
4. Continuous DC current rating. Maximum current for pulses as long as 1 second is higher but is dependent on pulse duration and duty cycle.

V _{(BR)DSS}	R _{DS(on)} MAX	I _D MAX
40 V	2.4 mΩ @ 10 V	136 A

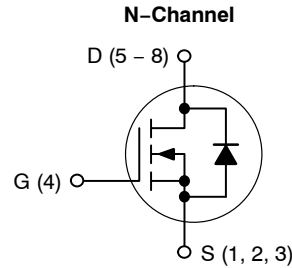

MARKING DIAGRAM

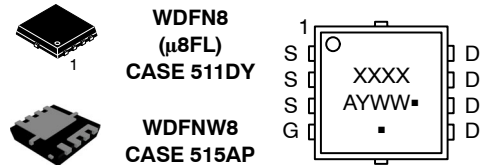

XXXX = Specific Device Code
 A = Assembly Location
 Y = Year
 WW = Work Week
 ■ = Pb-Free Package
 (Note: Microdot may be in either location)

ORDERING INFORMATION

See detailed ordering, marking and shipping information in the package dimensions section on page 5 of this data sheet.

NVTFS002N04C

ELECTRICAL CHARACTERISTICS (T_J = 25°C unless otherwise noted)

Parameter	Symbol	Test Condition	Min	Typ	Max	Unit
-----------	--------	----------------	-----	-----	-----	------

OFF CHARACTERISTICS

Drain-to-Source Breakdown Voltage	V _{(BR)DSS}	V _{GS} = 0 V, I _D = 250 μA	40			V
Zero Gate Voltage Drain Current	I _{DSS}	V _{GS} = 0 V, V _{DS} = 40 V		T _J = 25°C		10
				T _J = 125°C		250
Gate-to-Source Leakage Current	I _{GSS}	V _{DS} = 0 V, V _{GS} = 20 V			100	nA

ON CHARACTERISTICS (Note 5)

Gate Threshold Voltage	V _{GS(TH)}	V _{GS} = V _{DS} , I _D = 90 μA	2.5		3.5	V
Drain-to-Source On Resistance	R _{DS(on)}	V _{GS} = 10 V, I _D = 50 A		2.0	2.4	mΩ
Forward Transconductance	g _{FS}	V _{DS} = 15 V, I _D = 50 A		92		S

CHARGES AND CAPACITANCES

Input Capacitance	C _{iss}	V _{GS} = 0 V, f = 1.0 MHz, V _{DS} = 25 V		2250		pF
Output Capacitance	C _{oss}			1230		
Reverse Transfer Capacitance	C _{rss}			41		
Threshold Gate Charge	Q _{G(TH)}	V _{GS} = 10 V, V _{DS} = 20 V, I _D = 50 A		6.7		nC
Gate-to-Source Charge	Q _{GS}			11.4		
Gate-to-Drain Charge	Q _{GD}			5.7		
Total Gate Charge	Q _{G(TOT)}			34		

SWITCHING CHARACTERISTICS (Note 6)

Turn-On Delay Time	t _{d(on)}	V _{GS} = 10 V, V _{DS} = 32 V, I _D = 50 A		11		ns
Rise Time	t _r			77		
Turn-Off Delay Time	t _{d(off)}			23		
Fall Time	t _f			7		

DRAIN-SOURCE DIODE CHARACTERISTICS

Forward Diode Voltage	V _{SD}	V _{GS} = 0 V, I _S = 50 A		T _J = 25°C	0.84	1.2	V
				T _J = 125°C	0.72		
Reverse Recovery Time	t _{RR}	V _{GS} = 0 V, di/dt = 100 A/μs, I _S = 50 A		50		ns	
Charge Time	t _a			25			
Discharge Time	t _b			25			
Reverse Recovery Charge	Q _{RR}			50			nC

5. Pulse Test: Pulse Width ≤ 300 μs, Duty Cycle ≤ 2%.

6. Switching characteristics are independent of operating junction temperatures.

TYPICAL CHARACTERISTICS

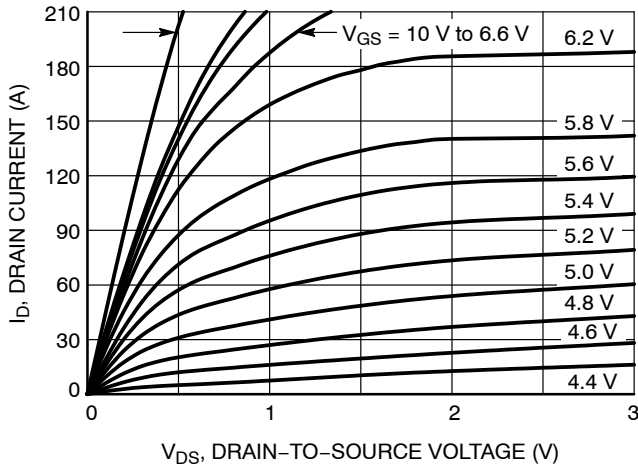

Figure 1. On-Region Characteristics

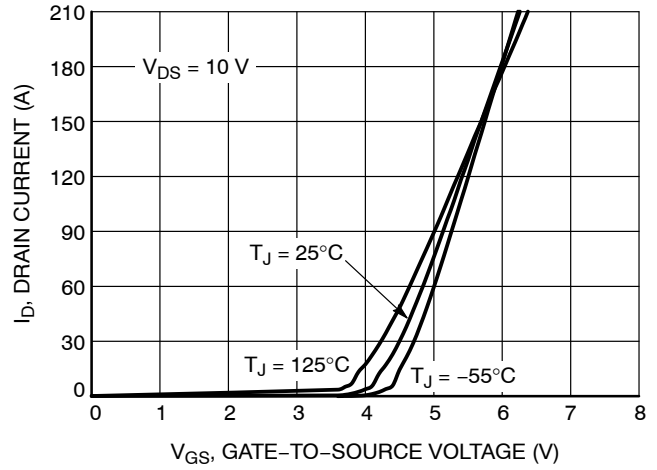

Figure 2. Transfer Characteristics

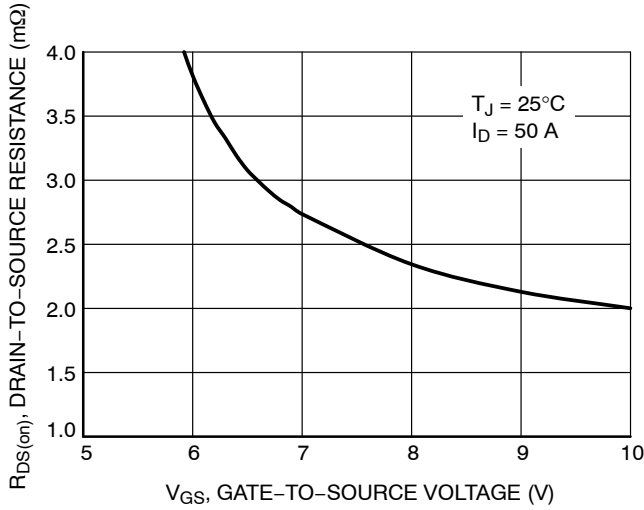

Figure 3. On-Resistance vs. Gate-to-Source Voltage

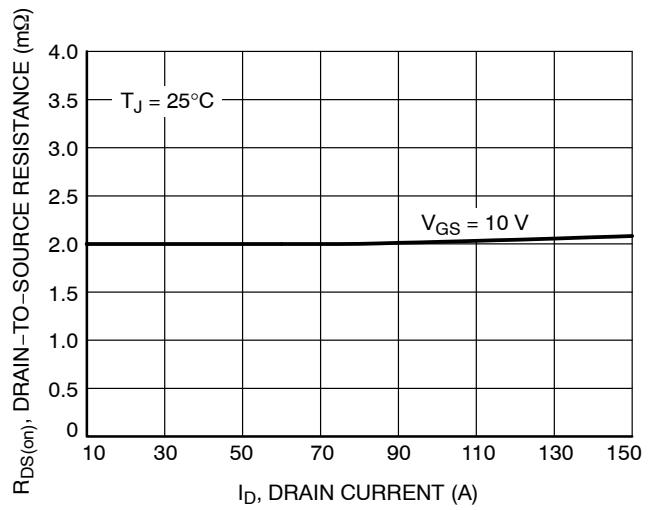

Figure 4. On-Resistance vs. Drain Current and Gate Voltage

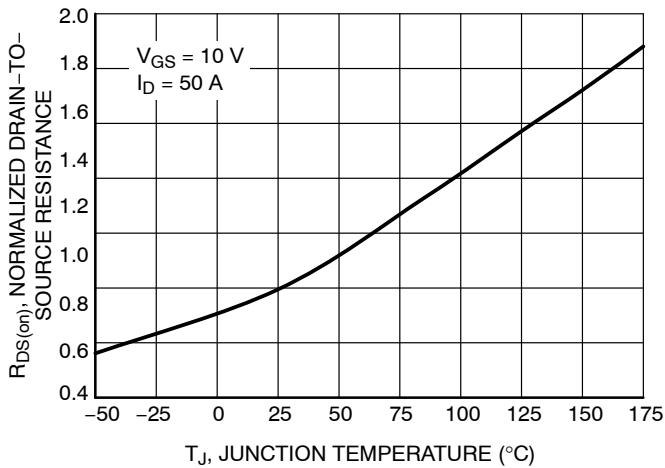

Figure 5. On-Resistance Variation with Temperature

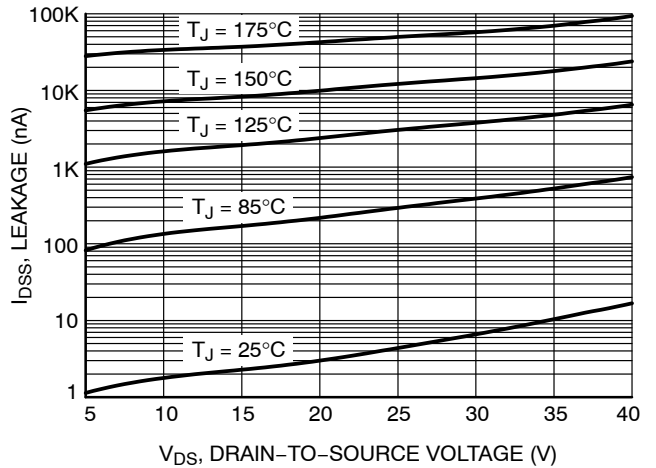

Figure 6. Drain-to-Source Leakage Current vs. Voltage

NVTFS002N04C

TYPICAL CHARACTERISTICS

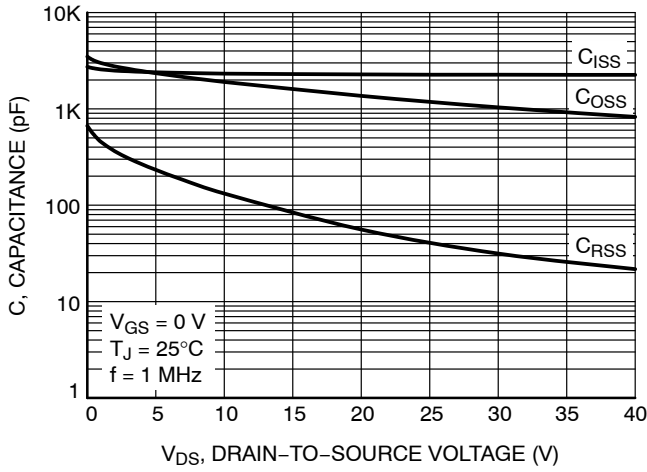

Figure 7. Capacitance Variation

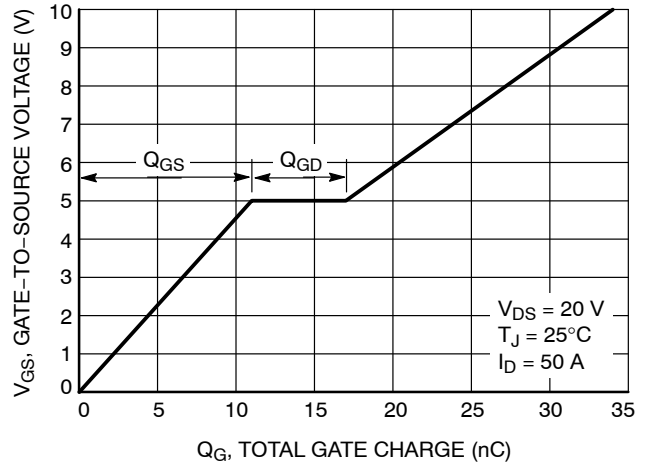

Figure 8. Gate-to-Source Voltage vs. Total Charge

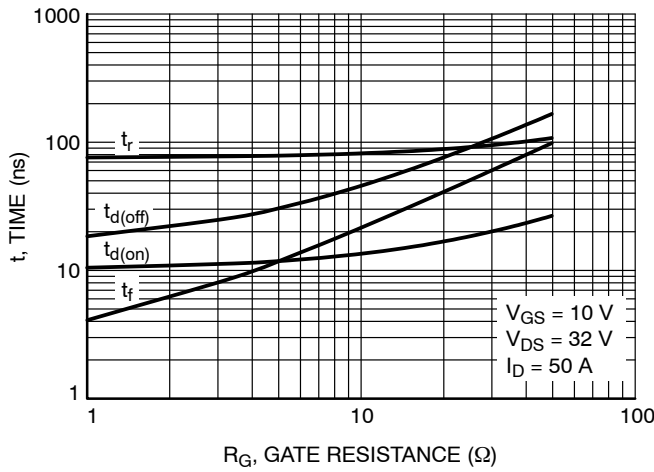

Figure 9. Resistive Switching Time Variation vs. Gate Resistance

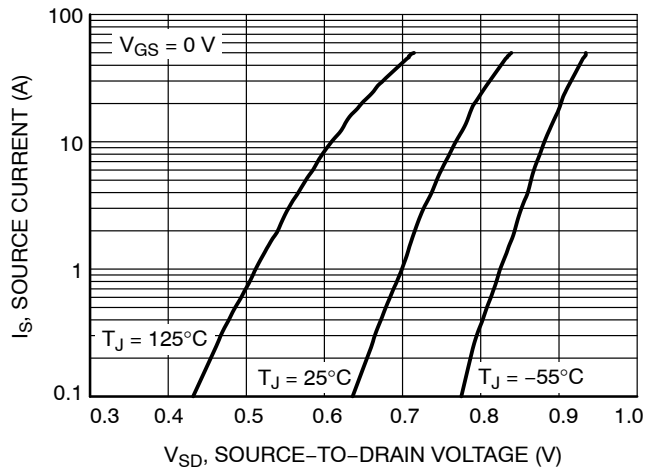

Figure 10. Diode Forward Voltage vs. Current

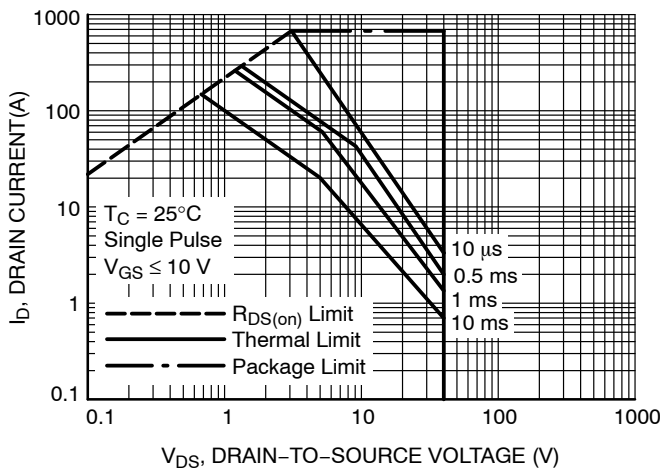

Figure 11. Maximum Rated Forward Biased Safe Operating Area

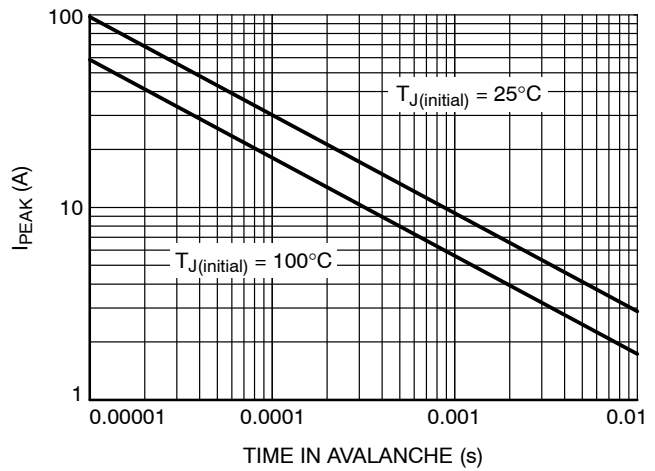

Figure 12. I_{PEAK} vs. Time in Avalanche

NVTFS002N04C

TYPICAL CHARACTERISTICS

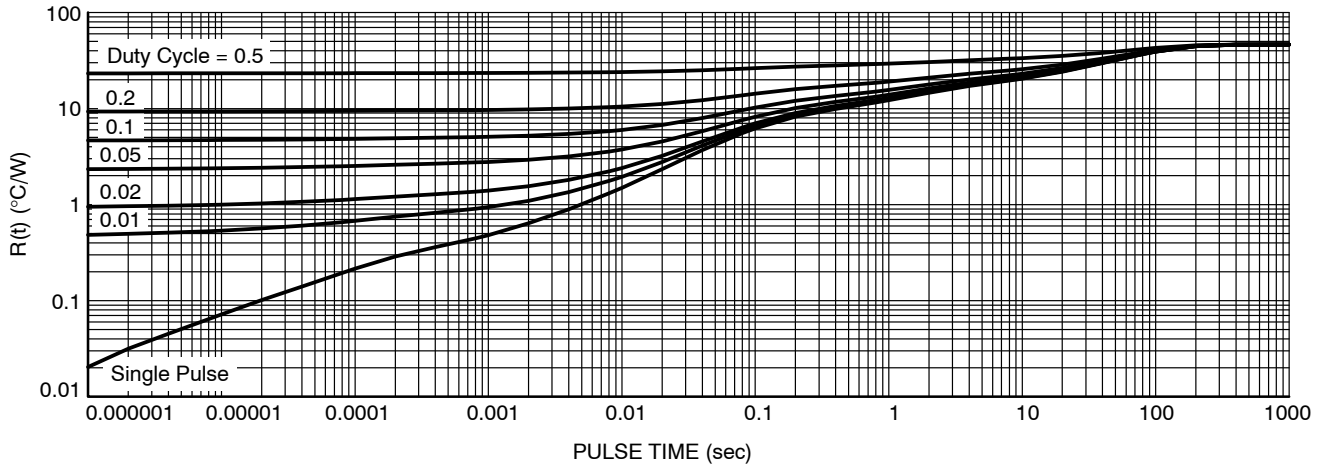

Figure 13. Thermal Characteristics

DEVICE ORDERING INFORMATION

Device	Marking	Package	Shipping [†]
NVTFS002N04CTAG	02NC	WDFN8 (Pb-Free)	1500 / Tape & Reel
NVTFWS002N04CTAG	02NW	WDFNW8 (Pb-Free, Wettable Flanks)	1500 / Tape & Reel

[†]For information on tape and reel specifications, including part orientation and tape sizes, please refer to our Tape and Reel Packaging Specifications Brochure, BRD8011/D.

MECHANICAL CASE OUTLINE PACKAGE DIMENSIONS



WDFN8 3.3x3.3, 0.65P
CASE 511DY
ISSUE A

DATE 21 AUG 2018

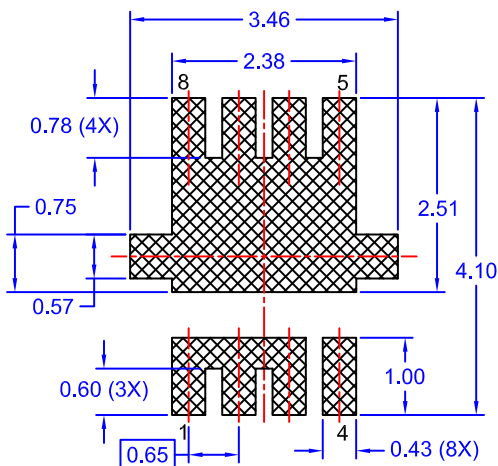
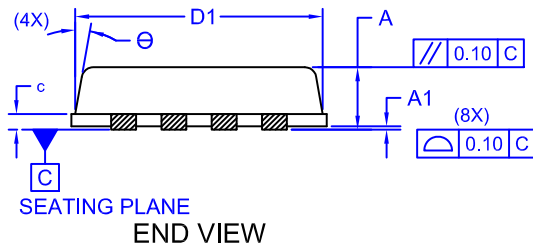
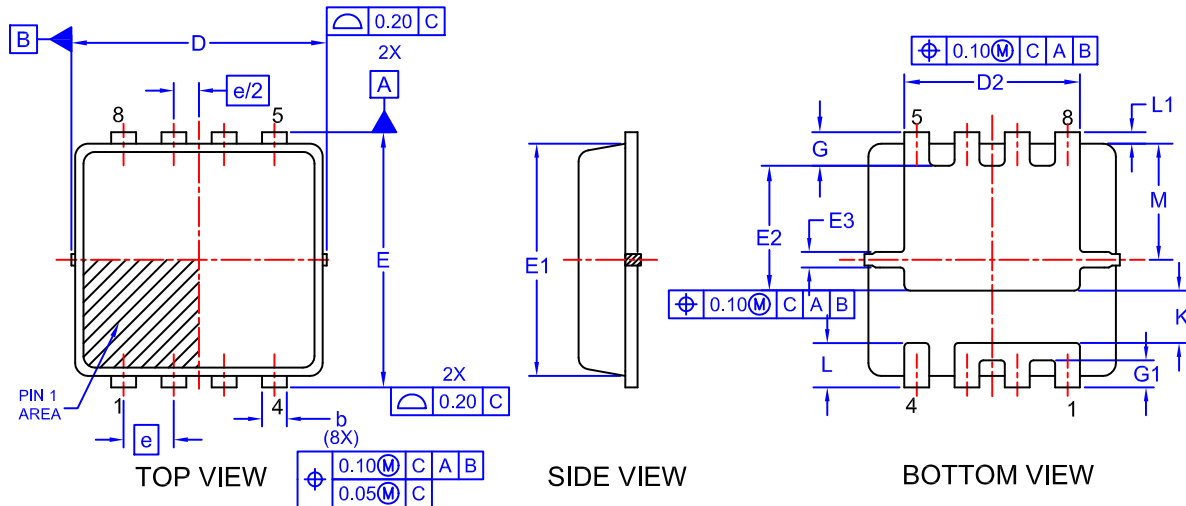

NOTES:

1. CONTROLLING DIMENSION: MILLIMETERS
2. DIMENSIONS D1 & E1 DO NOT INCLUDE MOLD FLASH PROTRUSIONS NOR GATE BURRS.

GENERIC MARKING DIAGRAM*

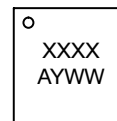

XXXX = Specific Device Code
A = Assembly Location
Y = Year Code
WW = Work Week Code

DIM	MILLIMETERS		
	MIN	NOM	MAX
A	0.70	0.75	0.80
A1	0.00	-	0.05
b	0.23	0.33	0.43
c	0.15	0.20	0.25
D	3.20	3.30	3.40
D1	2.95	3.13	3.30
E	3.20	3.30	3.40
E1	2.80	3.00	3.15
E2	1.40	1.60	1.80
E3	0.15	0.25	0.40
e	0.65 BSC		
G	0.30	0.43	0.55
G1	0.25	0.35	0.45
K	0.55	0.75	0.95
L	0.35	0.52	0.65
L1	0.06	0.15	0.30
M	1.35	1.50	1.60
θ	0	-	12

*This information is generic. Please refer to device data sheet for actual part marking. Pb-Free indicator, "G" or microdot "μ", may or may not be present. Some products may not follow the Generic Marking.

DOCUMENT NUMBER:	98AON90827G	Electronic versions are uncontrolled except when accessed directly from the Document Repository. Printed versions are uncontrolled except when stamped "CONTROLLED COPY" in red.
DESCRIPTION:	WDFN8 3.3x3.3, 0.65P	PAGE 1 OF 1

onsemi and ONSEMI are trademarks of Semiconductor Components Industries, LLC dba onsemi or its subsidiaries in the United States and/or other countries. onsemi reserves the right to make changes without further notice to any products herein. onsemi makes no warranty, representation or guarantee regarding the suitability of its products for any particular purpose, nor does onsemi assume any liability arising out of the application or use of any product or circuit, and specifically disclaims any and all liability, including without limitation special, consequential or incidental damages. onsemi does not convey any license under its patent rights nor the rights of others.

MECHANICAL CASE OUTLINE PACKAGE DIMENSIONS

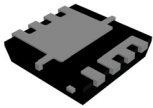

WDFNW8 3.30x3.30x0.75, 0.65P
CASE 515AP
ISSUE A

DATE 07 NOV 2023

NOTES:

1. DIMENSIONING AND TOLERANCING CONFORM TO ASME Y14.5-2018.
2. ALL DIMENSION ARE IN MILLIMETERS.
3. DIMENSION D1 AND E1 DO NOT INCLUDE MOLD FLASH, PROTRUSIONS, OR GATE BURRS.
4. FULL-CUT u8FL FUSED WF.

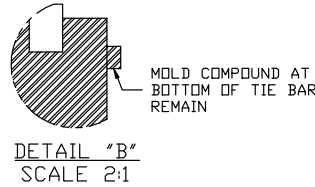
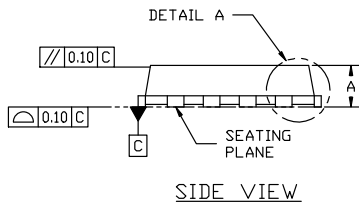
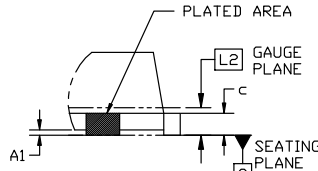
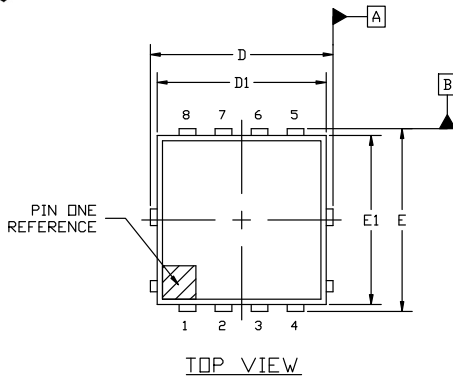

DIM	MILLIMETERS		
	MIN.	NDM.	MAX.
A	0.70	0.75	0.80
A1	0.00	----	0.05
b	0.23	0.33	0.43
c	0.15	0.20	0.25
D	3.20	3.30	3.40
D1	2.95	3.13	3.30
D2	1.98	2.20	2.40
E	3.20	3.30	3.40
E1	2.80	3.00	3.15
E2	1.40	1.60	1.80
E3	1.35	1.50	1.60
E4	0.15	0.25	0.40
e	0.65 BSC		
G	0.30	0.43	0.55
G1	0.25	0.35	0.45
K	0.55	0.75	0.95
L	0.35	0.52	0.65
L1	0.06	0.15	0.30
L2	0.25 BSC		

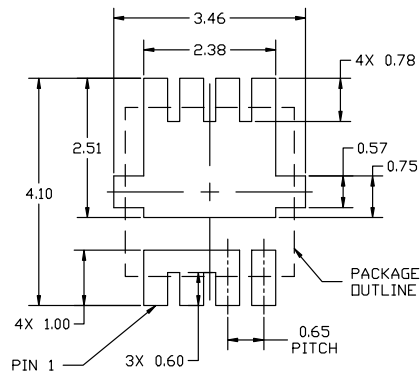
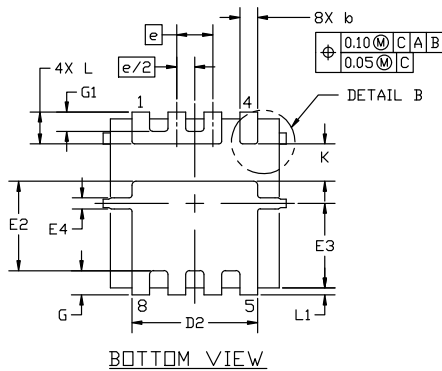

RECOMMENDED MOUNTING FOOTPRINT*

* FOR ADDITIONAL INFORMATION ON OUR Pb-FREE STRATEGY AND SOLDERING DETAILS, PLEASE DOWNLOAD THE ON SEMICONDUCTOR SOLDERING AND MOUNTING TECHNIQUES REFERENCE MANUAL, SOLDERM/D.

GENERIC MARKING DIAGRAM*

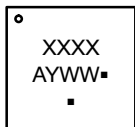

XXXX = Specific Device Code
A = Assembly Location
Y = Year
WW = Work Week
▪ = Pb-Free Package

*This information is generic. Please refer to device data sheet for actual part marking. Pb-Free indicator, "G" or microdot "▪", may or may not be present. Some products may not follow the Generic Marking.

(Note: Microdot may be in either location)

DOCUMENT NUMBER:	98AON24557H	Electronic versions are uncontrolled except when accessed directly from the Document Repository. Printed versions are uncontrolled except when stamped "CONTROLLED COPY" in red.
DESCRIPTION:	WDFNW8 3.30x3.30x0.75, 0.65P	PAGE 1 OF 1

onsemi and ONSEMI are trademarks of Semiconductor Components Industries, LLC dba onsemi or its subsidiaries in the United States and/or other countries. onsemi reserves the right to make changes without further notice to any products herein. onsemi makes no warranty, representation or guarantee regarding the suitability of its products for any particular purpose, nor does onsemi assume any liability arising out of the application or use of any product or circuit, and specifically disclaims any and all liability, including without limitation special, consequential or incidental damages. onsemi does not convey any license under its patent rights nor the rights of others.

onsemi, **Onsemi**, and other names, marks, and brands are registered and/or common law trademarks of Semiconductor Components Industries, LLC dba "**onsemi**" or its affiliates and/or subsidiaries in the United States and/or other countries. **onsemi** owns the rights to a number of patents, trademarks, copyrights, trade secrets, and other intellectual property. A listing of **onsemi**'s product/patent coverage may be accessed at www.onsemi.com/site/pdf/Patent-Marking.pdf. **onsemi** reserves the right to make changes at any time to any products or information herein, without notice. The information herein is provided "as-is" and **onsemi** makes no warranty, representation or guarantee regarding the accuracy of the information, product features, availability, functionality, or suitability of its products for any particular purpose, nor does **onsemi** assume any liability arising out of the application or use of any product or circuit, and specifically disclaims any and all liability, including without limitation special, consequential or incidental damages. Buyer is responsible for its products and applications using **onsemi** products, including compliance with all laws, regulations and safety requirements or standards, regardless of any support or applications information provided by **onsemi**. "Typical" parameters which may be provided in **onsemi** data sheets and/or specifications can and do vary in different applications and actual performance may vary over time. All operating parameters, including "Typicals" must be validated for each customer application by customer's technical experts. **onsemi** does not convey any license under any of its intellectual property rights nor the rights of others. **onsemi** products are not designed, intended, or authorized for use as a critical component in life support systems or any FDA Class 3 medical devices or medical devices with a same or similar classification in a foreign jurisdiction or any devices intended for implantation in the human body. Should Buyer purchase or use **onsemi** products for any such unintended or unauthorized application, Buyer shall indemnify and hold **onsemi** and its officers, employees, subsidiaries, affiliates, and distributors harmless against all claims, costs, damages, and expenses, and reasonable attorney fees arising out of, directly or indirectly, any claim of personal injury or death associated with such unintended or unauthorized use, even if such claim alleges that **onsemi** was negligent regarding the design or manufacture of the part. **onsemi** is an Equal Opportunity/Affirmative Action Employer. This literature is subject to all applicable copyright laws and is not for resale in any manner.

ADDITIONAL INFORMATION

TECHNICAL PUBLICATIONS:

Technical Library: www.onsemi.com/design/resources/technical-documentation
onsemi Website: www.onsemi.com

ONLINE SUPPORT: www.onsemi.com/support

For additional information, please contact your local Sales Representative at www.onsemi.com/support/sales