

LPF Series

Common Mode Noise Filter

HF **RoHS** **Pb**



Description

Littelfuse LPF Series is a common mode noise filter that covers the specification of the requirements for high-speed differential serial interfaces, corresponding to new high-speed data transmission specification, like C-PHY.

Features & Benefits

- Effective for suppressing common mode noise and almost no effect for high-speed differential data line
- Ultra-small size as low as 0.90 X 0.68 X 0.45 mm
- Ceramic based SMD component
- Non-polarized product
- Conforming to RoHS directive
- Ultra-small size
- High voltage

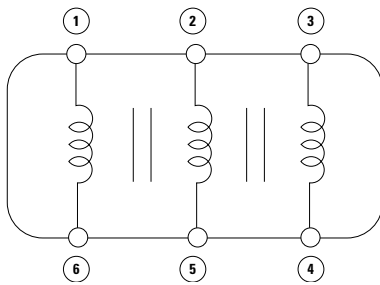
Functional Block Diagram



Applications

- Mobile phone and tablet
- Portable/wearable devices
- Other consumer devices

Electrical Specifications

Part Number	Common Mode Impedance (Ω) @ 100 Mhz	Max DC Resistance (Ω) ¹	Minimum Insulation Resistance (M Ω) @5 V	Max Rated Current (mA) ¹
LPF090703A250TG	25 (+/-25%)	5	10	80
LPF090703A350TG	35 (+/-25%)	8	10	70

Note:

1. Test condition 25 °C±2 °C
Operating Temperature: -40 °C ~ 85 °C

LPF Series

Common Mode Noise Filter

Frequency Response

LPF090703A250TG

Impedance Curves

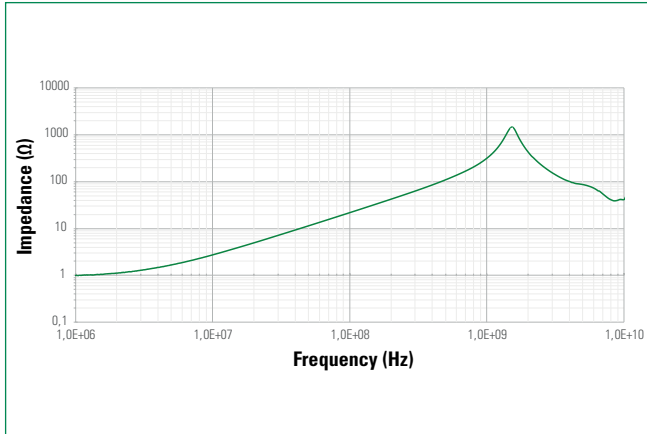

Transmission Characteristics (S-Parameter)

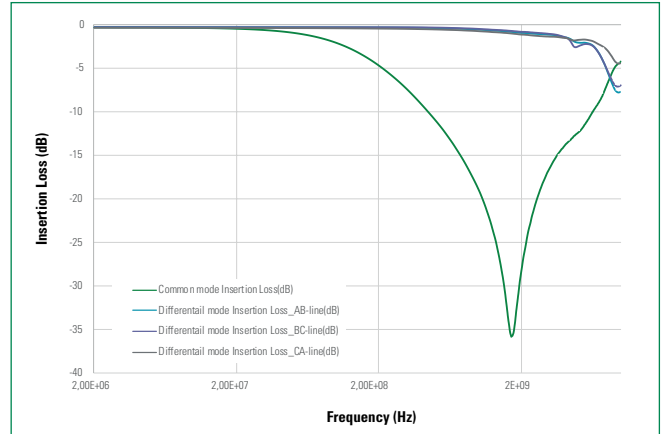

Differential Characteristic Impedance

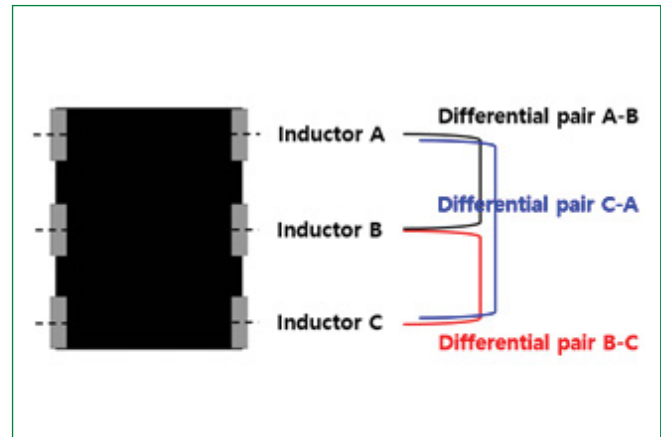
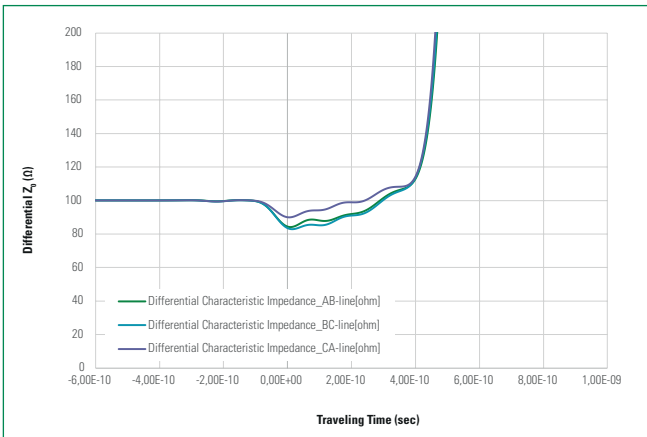

LPF Series

Common Mode Noise Filter

Frequency Response

LPF090703A350TG

Impedance Curves

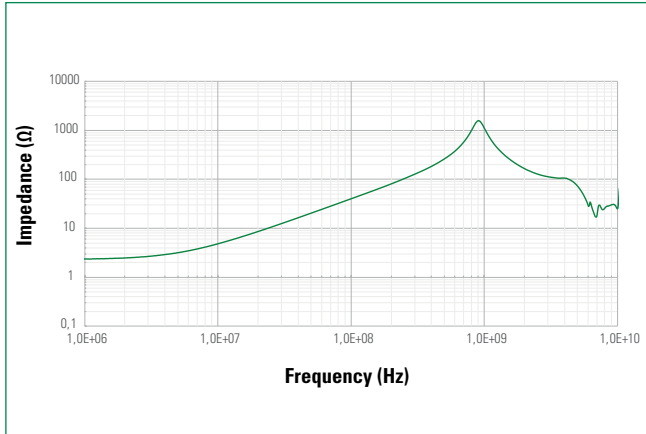

Transmission Characteristics (S-Parameter)

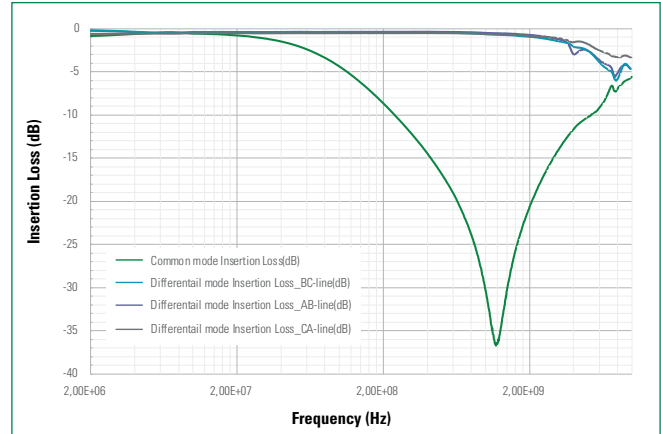

Differential Characteristic Impedance

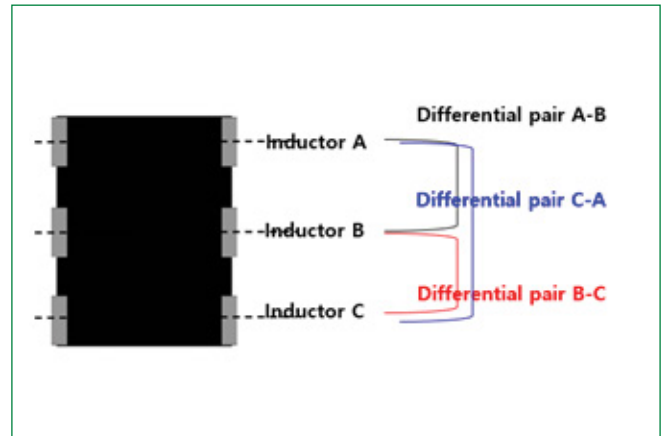
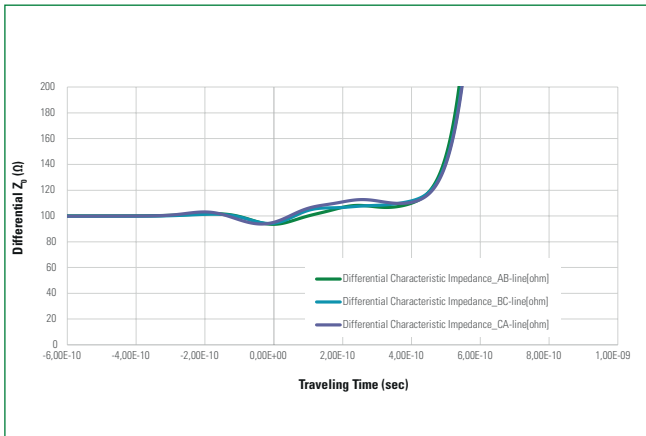

LPF Series

Common Mode Noise Filter

Dimension and Recommended Footprint

All dimensions in mm

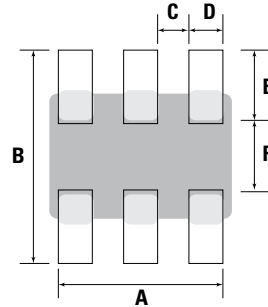
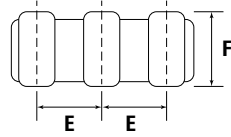
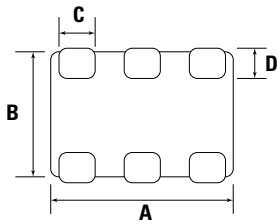

A	B	C	D	E	F
0.90	0.68	0.18	0.13	0.35	0.45

Tolerance +/- 0.05 mm

A	B	C	D	E	F
0.85	0.99	0.20	0.15	0.33	0.33

Tolerance +/- 0.05 mm

Tape and Reel Information

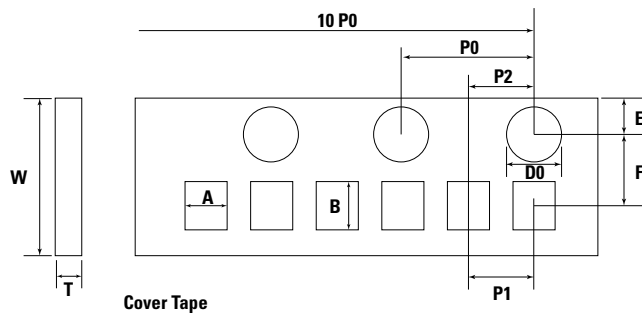
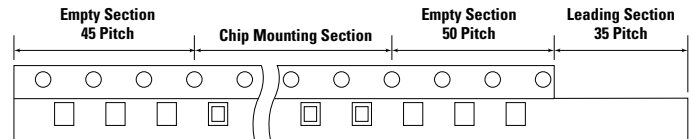
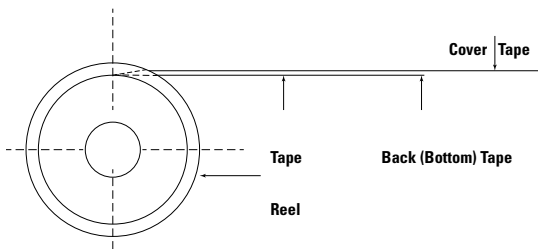

Symbol	A	B	E	F	D0	P1	P2	P0	10P0	W	T
Dimension	0.81	1.12	1.75	3.50	1.55	2.00	2.00	4.00	40.00	8.00	0.58
Tolerance	±0.03	±0.03	±0.05	±0.05	±0.03	±0.05	±0.05	±0.05	±0.10	±0.10	±0.04

Unit = mm

LPF Series

Common Mode Noise Filter

Recommended Land Pattern

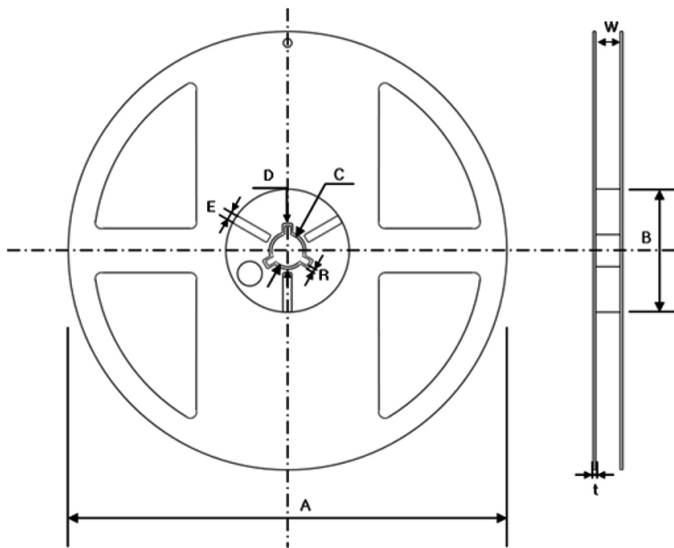

Notes:

1. Reel Materials : Polystyrene
2. Label
3. Taping
 - Standard Packing Quantity per Reel (Ø178)
 - Paper Tape: 10,000 pcs/reel

Unit = mm

Code	A	B	C	D	E	W	t	R
Dimension	Ø178±2	Min. Ø50	Ø13±0.5	Ø20±0.8	Ø3.0±0.5	10±1.5	1.3±0.2	1.0±0.2

Disclaimer Notice - Information furnished is believed to be accurate and reliable. However, users should independently evaluate the suitability of and test each product selected for their own applications. Littelfuse products are not designed for, and may not be used in, all applications. Read complete Disclaimer Notice at <http://www.littelfuse.com/disclaimer-electronics>.