

## LISA3-W-PIN

~35° wide beam with location pin installation

### SPECIFICATION:

Dimensions	Ø 9.9 mm
Height	7 mm
Fastening	pin
ROHS compliant	yes ⓘ

### MATERIALS:

Component	Type	Material	Colour	Finish
LISA3-W	Single lens	PMMA	clear	
LISA3-HLD-PIN	Holder	PC	black	

### ORDERING INFORMATION:

Component		Qty in box	MOQ	MPQ	Box weight (kg)
FP16560_LISA3-W-PIN	Single lens	2000	300	100	1.3
» Box size: 310 x 230 x 60 mm					



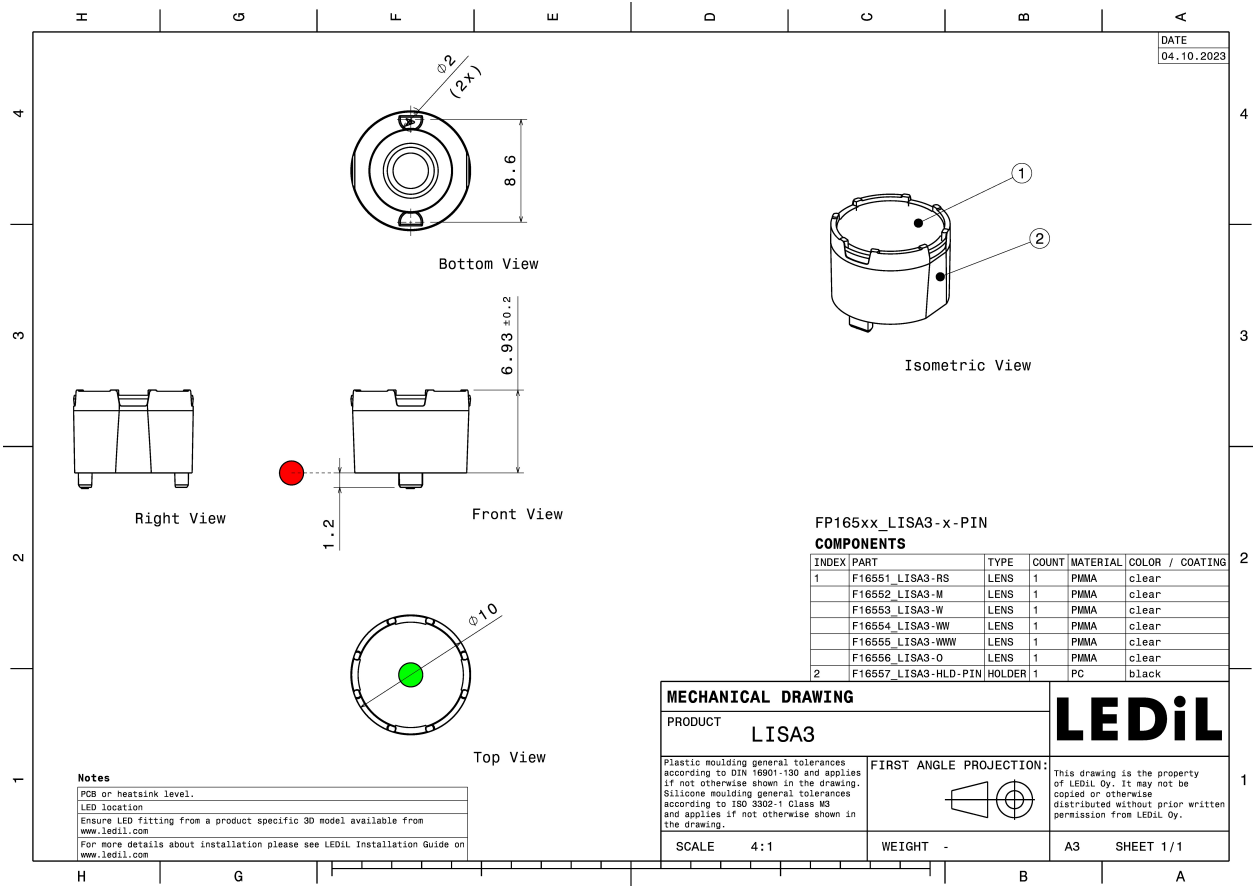

See also our general installation guide: [www.ledil.com/installation\\_guide](http://www.ledil.com/installation_guide)

#### OPTICAL RESULTS (MEASURED):



LED XD16  
 FWHM / FWTM 32.0° / 52.0°  
 Efficiency 77 %  
 Peak intensity 2.3 cd/lm  
 LEDs/each optic 1  
 Light colour White  
 Required components:

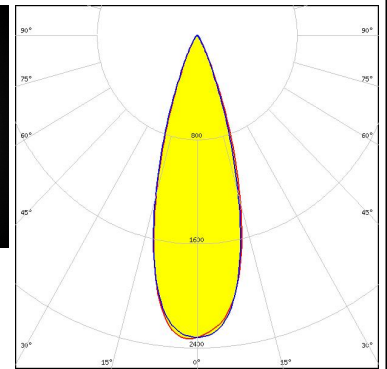
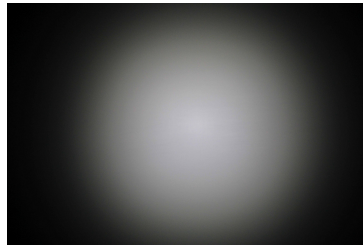

LED XP-E2  
 FWHM / FWTM 29.0° / 46.0°  
 Efficiency 86 %  
 Peak intensity 3.2 cd/lm  
 LEDs/each optic 1  
 Light colour White  
 Required components:

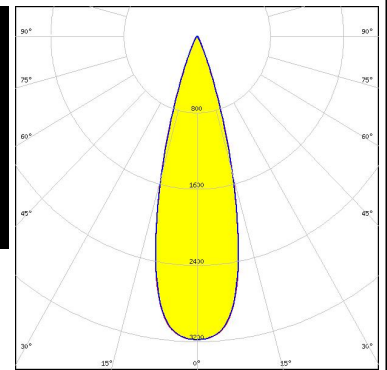
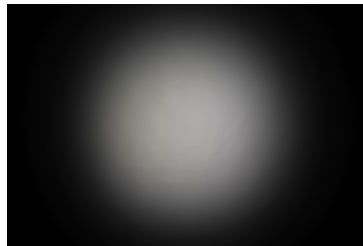

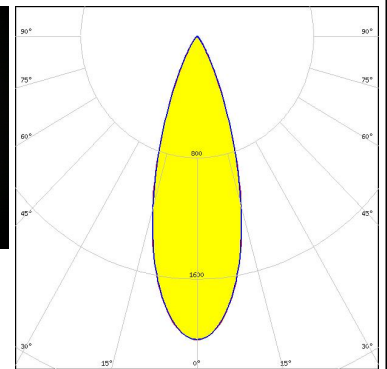
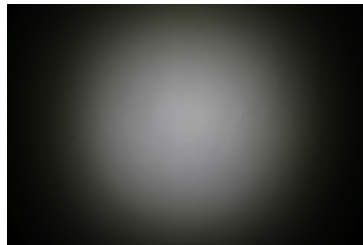

LED XP-G3  
 FWHM / FWTM 34.0° / 58.0°  
 Efficiency 78 %  
 Peak intensity 2 cd/lm  
 LEDs/each optic 1  
 Light colour White  
 Required components:

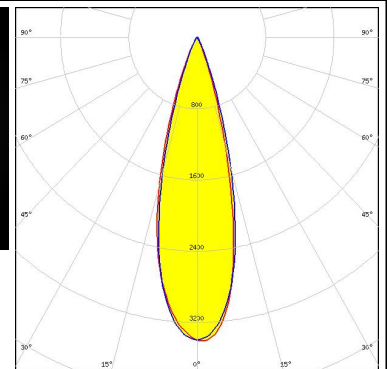
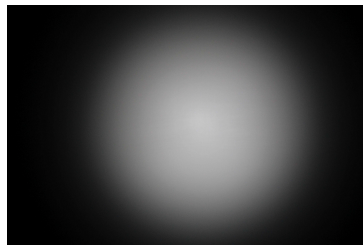

LED LUXEON CZ  
 FWHM / FWTM 29.0° / 47.0°  
 Efficiency 88 %  
 Peak intensity 3.4 cd/lm  
 LEDs/each optic 1  
 Light colour White  
 Required components:



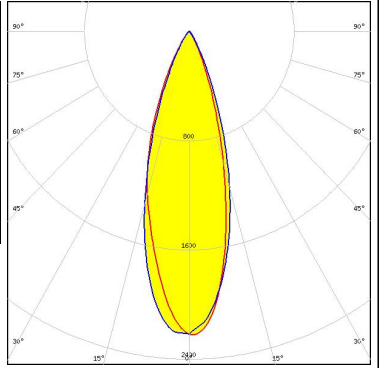

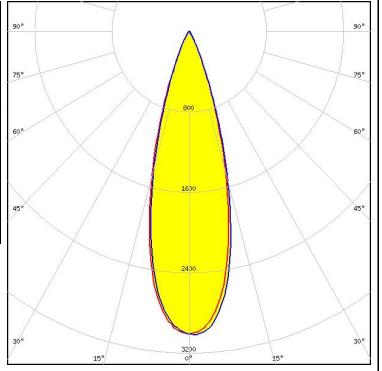
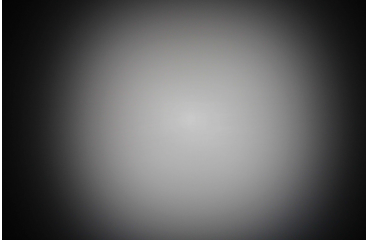
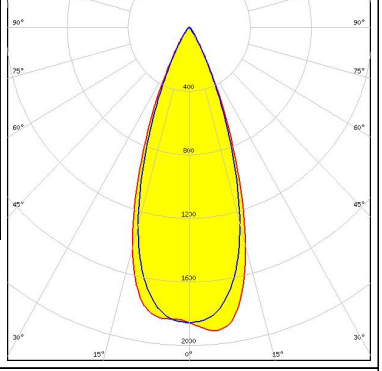
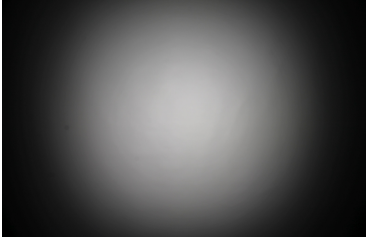
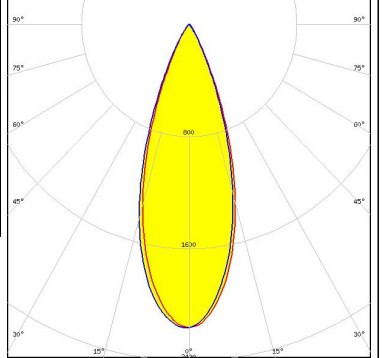



#### OPTICAL RESULTS (MEASURED):

<p><b>NICHIA</b></p> <p>LED NF2x757G</p> <p>FWHM / FWTM 32.0° / 57.0°</p> <p>Efficiency 79 %</p> <p>Peak intensity 2.2 cd/lm</p> <p>LEDs/each optic 1</p> <p>Light colour White</p> <p>Required components:</p>		
<p><b>OSRAM</b> Opto Semiconductors</p> <p>LED OSCONIQ C 2424</p> <p>FWHM / FWTM 30.0° / 50.0°</p> <p>Efficiency 88 %</p> <p>Peak intensity 3 cd/lm</p> <p>LEDs/each optic 1</p> <p>Light colour White</p> <p>Required components:</p>		
<p><b>OSRAM</b> Opto Semiconductors</p> <p>LED OSLON Square CSSRM2/CSSRM3</p> <p>FWHM / FWTM 39.0° / 60.0°</p> <p>Efficiency 88 %</p> <p>Peak intensity 1.9 cd/lm</p> <p>LEDs/each optic 1</p> <p>Light colour White</p> <p>Required components:</p>		
<p><b>SAMSUNG</b></p> <p>LED LH351C</p> <p>FWHM / FWTM 35.0° / 58.0°</p> <p>Efficiency 88 %</p> <p>Peak intensity 2.2 cd/lm</p> <p>LEDs/each optic 1</p> <p>Light colour White</p> <p>Required components:</p>		

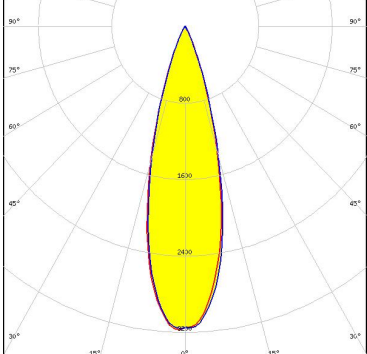
#### OPTICAL RESULTS (MEASURED):

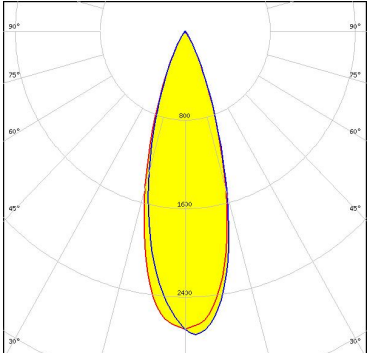

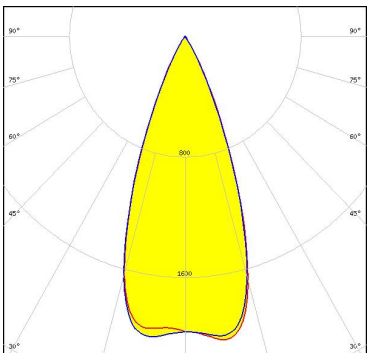
#### OPTICAL RESULTS (SIMULATED):

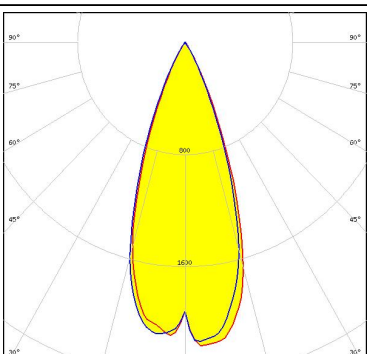
<p></p> <p>LED CSP 2323 (BXCP)</p> <p>FWHM / FWTM 28.0° / 47.0°</p> <p>Efficiency 81 %</p> <p>Peak intensity 3.2 cd/lm</p> <p>LEDs/each optic 1</p> <p>Light colour White</p> <p>Required components:</p>	
<p></p> <p>LED J Series 2835</p> <p>FWHM / FWTM 31.0° / 54.0°</p> <p>Efficiency 88 %</p> <p>Peak intensity 2.7 cd/lm</p> <p>LEDs/each optic 1</p> <p>Light colour White</p> <p>Required components:</p>	
<p></p> <p>LED XP-E</p> <p>FWHM / FWTM 41.0° / 59.0°</p> <p>Efficiency 92 %</p> <p>Peak intensity 2.1 cd/lm</p> <p>LEDs/each optic 1</p> <p>Light colour White</p> <p>Required components:</p>	
<p></p> <p>LED XP-G2</p> <p>FWHM / FWTM 39.0° / 58.0°</p> <p>Efficiency 90 %</p> <p>Peak intensity 2.2 cd/lm</p> <p>LEDs/each optic 1</p> <p>Light colour White</p> <p>Required components:</p>	

#### OPTICAL RESULTS (SIMULATED):



LED XP-G2 HE  
 FWHM / FWTM 48.0° / 72.0°  
 Efficiency 87 %  
 Peak intensity 1.4 cd/lm  
 LEDs/each optic 1  
 Light colour White  
 Required components:

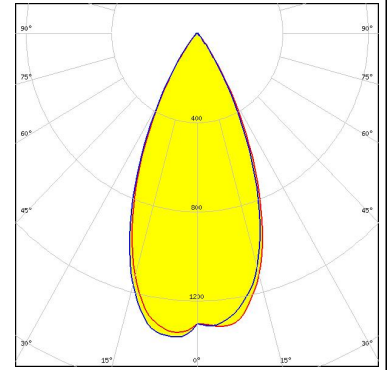

LED XT-E  
 FWHM / FWTM 30.0° / 49.0°  
 Efficiency 82 %  
 Peak intensity 2.9 cd/lm  
 LEDs/each optic 1  
 Light colour White  
 Required components:

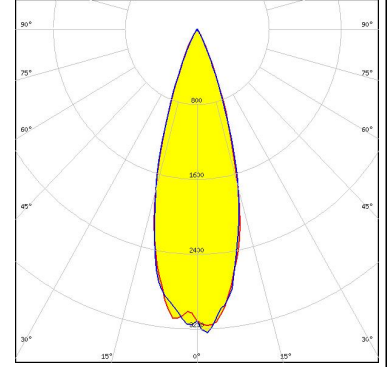

LED LUXEON 2835 Line  
 FWHM / FWTM 30.0° / 52.0°  
 Efficiency 89 %  
 Peak intensity 3.1 cd/lm  
 LEDs/each optic 1  
 Light colour White  
 Required components:

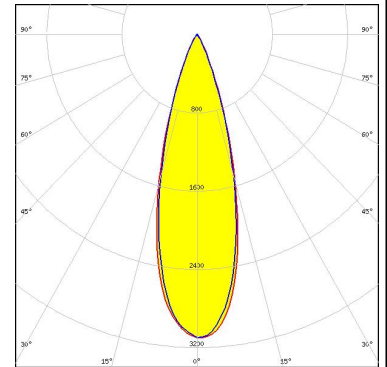

LED LUXEON 3030 2D (Round LES)  
 FWHM / FWTM 30.0° / 50.0°  
 Efficiency 85 %  
 Peak intensity 3.2 cd/lm  
 LEDs/each optic 1  
 Light colour White  
 Required components:

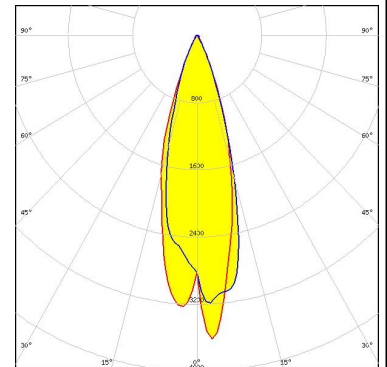

#### OPTICAL RESULTS (SIMULATED):

##### LUMILEDS

LED LUXEON HL2X  
 FWHM / FWTM 46.0° / 68.0°  
 Efficiency 89 %  
 Peak intensity 1.5 cd/lm  
 LEDs/each optic 1  
 Light colour White  
 Required components:

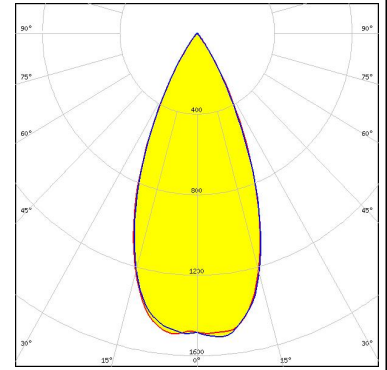

##### LUMILEDS

LED LUXEON TX  
 FWHM / FWTM 36.0° / 55.0°  
 Efficiency 87 %  
 Peak intensity 2.3 cd/lm  
 LEDs/each optic 1  
 Light colour White  
 Required components:

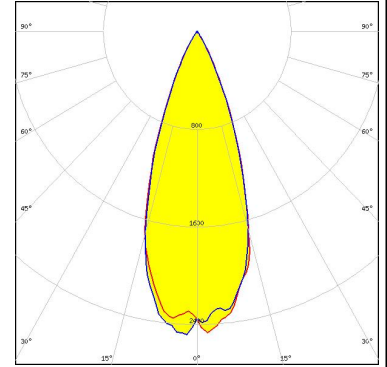

##### LUMILEDS

LED LUXEON V2  
 FWHM / FWTM 36.0° / 61.0°  
 Efficiency 90 %  
 Peak intensity 2.2 cd/lm  
 LEDs/each optic 1  
 Light colour White  
 Required components:

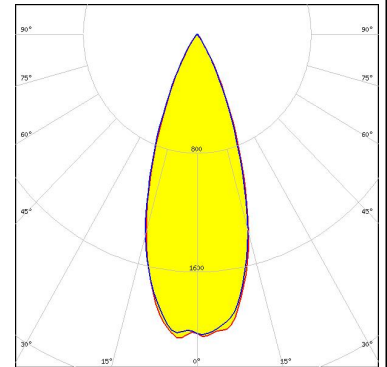

##### LUMILEDS

LED LUXEON Z  
 FWHM / FWTM 27.5° / 42.0°  
 Efficiency 88 %  
 Peak intensity 4.2 cd/lm  
 LEDs/each optic 1  
 Light colour White  
 Required components:

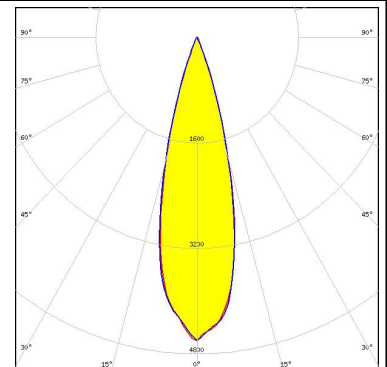



#### OPTICAL RESULTS (SIMULATED):

##### LUMILEDS

LED LUXEON Z ES  
 FWHM / FWTM 30.0° / 46.0°  
 Efficiency 89 %  
 Peak intensity 3.4 cd/lm  
 LEDs/each optic 1  
 Light colour White  
 Required components:

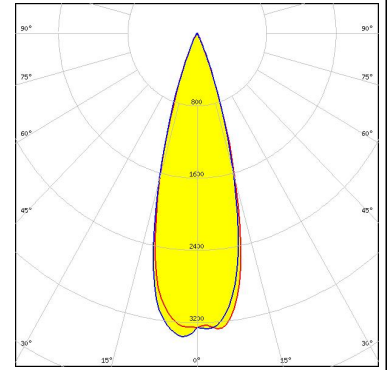

##### LUMINUS

LED SST-10-IR-B90  
 FWHM / FWTM 34.0° / 51.0°  
 Efficiency 87 %  
 Peak intensity 2.6 cd/lm  
 LEDs/each optic 1  
 Light colour IR  
 Required components:

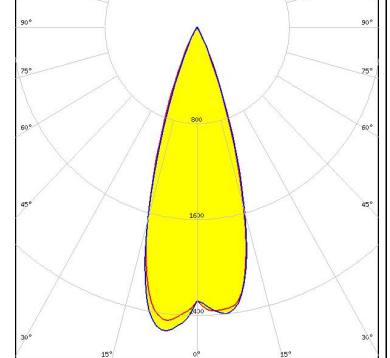
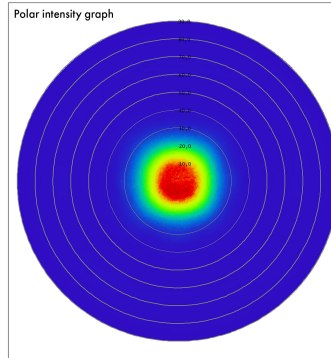

##### LUMINUS

LED SST-20  
 FWHM / FWTM 32.0° / 52.0°  
 Efficiency 87 %  
 Peak intensity 2.7 cd/lm  
 LEDs/each optic 1  
 Light colour White  
 Required components:

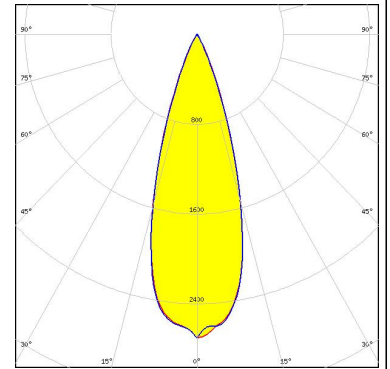

##### NICHIA

LED NCSU276C  
 FWHM / FWTM 41.0° / 57.0°  
 Efficiency 91 %  
 LEDs/each optic 1  
 Light colour UV-A  
 Required components:

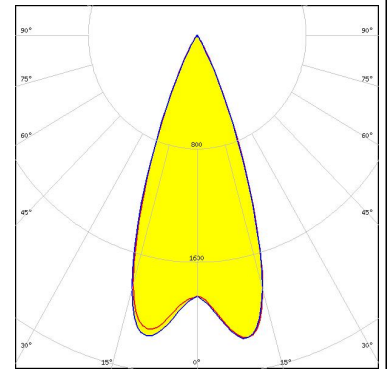

#### OPTICAL RESULTS (SIMULATED):

<p><b>NICHIA</b></p> <p>LED: NCSxx19B            FWHM / FWTM: 34.0° / 54.0°            Efficiency: 84 %            Peak intensity: 2.4 cd/lm            LEDs/each optic: 1            Light colour: White            Required components:</p>	
<p><b>NICHIA</b></p> <p>LED: NVSW219F            FWHM / FWTM: 46.0° / 68.0°            Efficiency: 88 %            Peak intensity: 1.5 cd/lm            LEDs/each optic: 1            Light colour: White            Required components:</p>	
<p><b>NICHIA</b></p> <p>LED: NVSxx19B/NVSxx19C            FWHM / FWTM: 38.9° / 62.5°            Efficiency: 83 %            Peak intensity: 1.8 cd/lm            LEDs/each optic: 1            Light colour: White            Required components:</p>	
<p><b>OSRAM</b>  <small>Opto Semiconductors</small></p> <p>LED: Duris S5 (2 chip)            FWHM / FWTM: 30.0° / 52.0°            Efficiency: 87 %            Peak intensity: 2.9 cd/lm            LEDs/each optic: 1            Light colour: White            Required components:</p>	

#### OPTICAL RESULTS (SIMULATED):

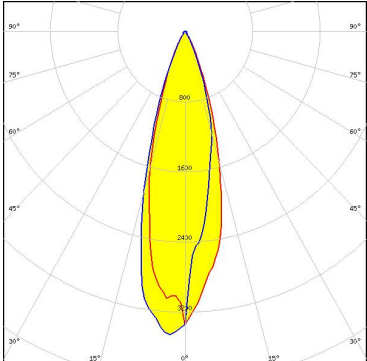
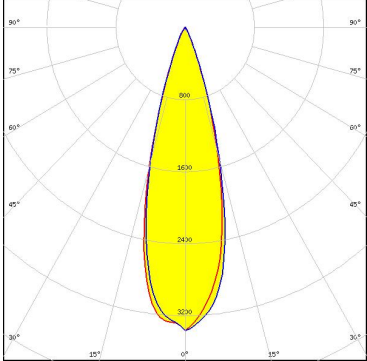
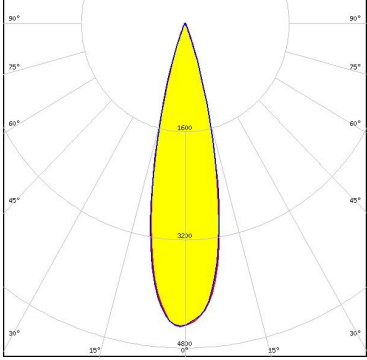
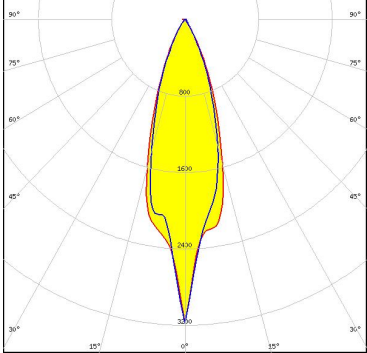
<p><b>OSRAM</b> Opto Semiconductors</p> <p>LED Duris S5 (Single chip)</p> <p>FWHM / FWTM 30.0° / 50.0°</p> <p>Efficiency 86 %</p> <p>Peak intensity 3.2 cd/lm</p> <p>LEDs/each optic 1</p> <p>Light colour White</p> <p>Required components:</p>	
<p><b>OSRAM</b> Opto Semiconductors</p> <p>LED OSCONIQ P 3030</p> <p>FWHM / FWTM 29.0° / 46.0°</p> <p>Efficiency 87 %</p> <p>Peak intensity 3.4 cd/lm</p> <p>LEDs/each optic 1</p> <p>Light colour White</p> <p>Required components:</p>	
<p><b>OSRAM</b> Opto Semiconductors</p> <p>LED OSLON Black</p> <p>FWHM / FWTM 25.0° / 40.0°</p> <p>Efficiency 88 %</p> <p>Peak intensity 4.5 cd/lm</p> <p>LEDs/each optic 1</p> <p>Light colour White</p> <p>Required components:</p>	
<p><b>OSRAM</b> Opto Semiconductors</p> <p>LED OSLON Square EC</p> <p>FWHM / FWTM 35.0° / 55.0°</p> <p>Efficiency 88 %</p> <p>Peak intensity 2.4 cd/lm</p> <p>LEDs/each optic 1</p> <p>Light colour White</p> <p>Required components:</p>	

#### OPTICAL RESULTS (SIMULATED):

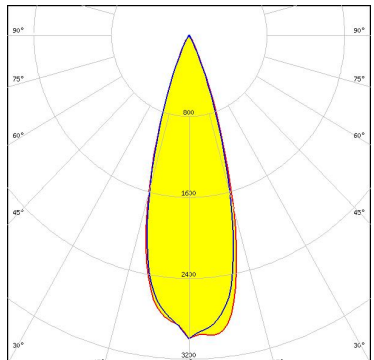
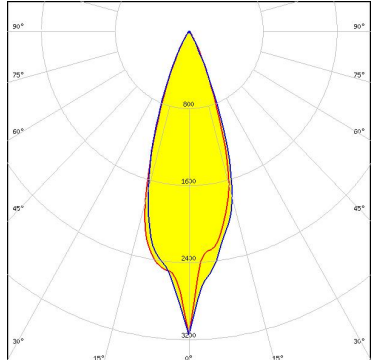
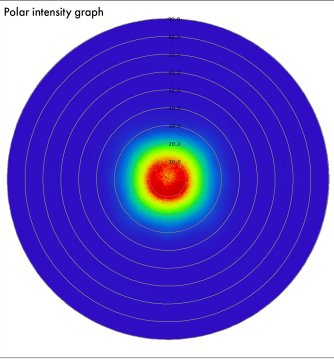
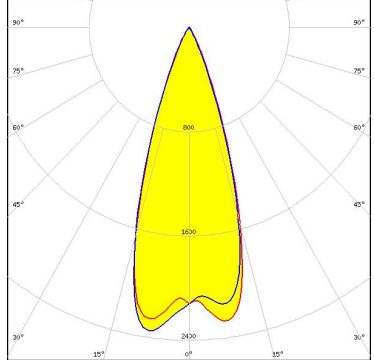
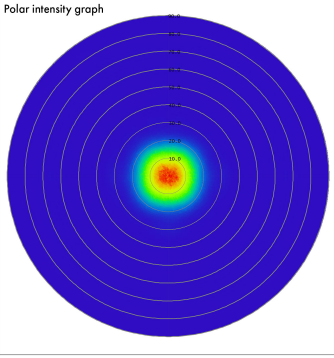
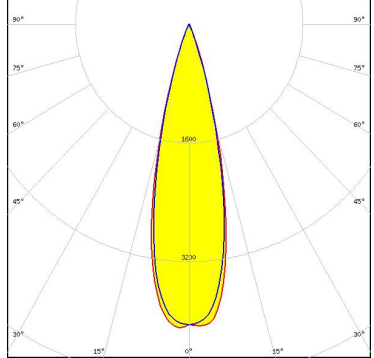
<p><b>OSRAM</b> Opto Semiconductors</p> <p>LED: OSLOM Square Flat</p> <p>FWHM / FWTM: 32.0° / 50.0°</p> <p>Efficiency: 89 %</p> <p>Peak intensity: 3 cd/lm</p> <p>LEDs/each optic: 1</p> <p>Light colour: White</p> <p>Required components:</p>		
<p><b>OSRAM</b> Opto Semiconductors</p> <p>LED: OSLOM SSL 150</p> <p>FWHM / FWTM: 35.0° / 52.0°</p> <p>Efficiency: 90 %</p> <p>Peak intensity: 2.6 cd/lm</p> <p>LEDs/each optic: 1</p> <p>Light colour: White</p> <p>Required components:</p>		
<p><b>OSRAM</b> Opto Semiconductors</p> <p>LED: OSLOM SSL 80</p> <p>FWHM / FWTM: 35.0° / 53.0°</p> <p>Efficiency: 87 %</p> <p>LEDs/each optic: 1</p> <p>Light colour: Far Red</p> <p>Required components:</p>	<p>Polar intensity graph</p> 	
<p><b>OSRAM</b> Opto Semiconductors</p> <p>LED: SFH 4715S</p> <p>FWHM / FWTM: 26.0° / 40.0°</p> <p>Efficiency: 87 %</p> <p>LEDs/each optic: 1</p> <p>Light colour: IR</p> <p>Required components:</p>	<p>Polar intensity graph</p> 	

#### OPTICAL RESULTS (SIMULATED):

#### OSRAM

Opto Semiconductors

LED SFH 4716S  
 FWHM / FWTM 31.0° / 47.0°  
 Efficiency 86 %  
 LEDs/each optic 1  
 Light colour IR  
 Required components:

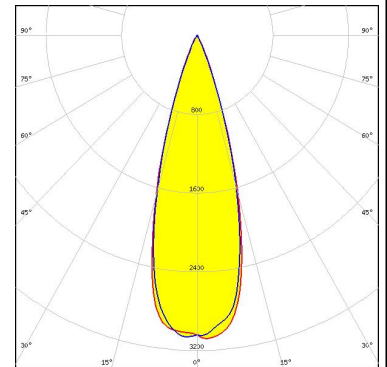
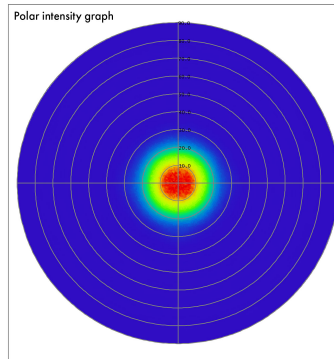

#### OSRAM

Opto Semiconductors

LED SYNIOS S2222  
 FWHM / FWTM 30.0° / 48.0°  
 Efficiency 97 %  
 Peak intensity 3.5 cd/lm  
 LEDs/each optic 1  
 Light colour White  
 Required components:

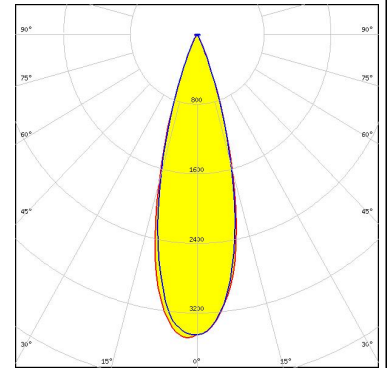

#### SAMSUNG

LED LH351D  
 FWHM / FWTM 41.0° / 73.0°  
 Efficiency 85 %  
 Peak intensity 1.5 cd/lm  
 LEDs/each optic 1  
 Light colour White  
 Required components:

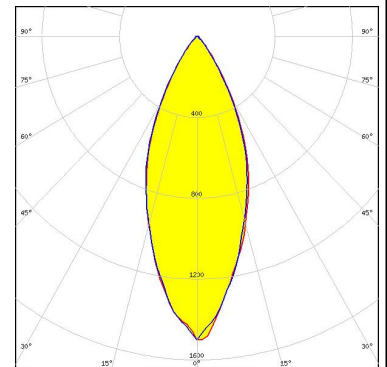

#### SAMSUNG

LED LM301A  
 FWHM / FWTM 29.0° / 48.0°  
 Efficiency 87 %  
 Peak intensity 3.5 cd/lm  
 LEDs/each optic 1  
 Light colour White  
 Required components:

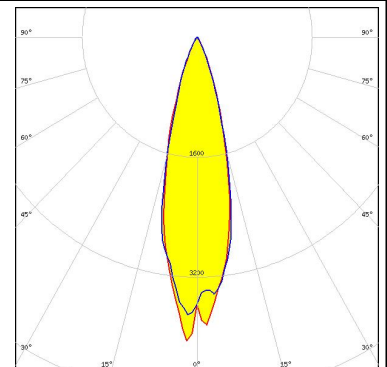

#### OPTICAL RESULTS (SIMULATED):

### SAMSUNG

LED LM302A  
 FWHM / FWTM 30.0° / 51.0°  
 Efficiency 87 %  
 Peak intensity 3.1 cd/lm  
 LEDs/each optic 1  
 Light colour White  
 Required components:

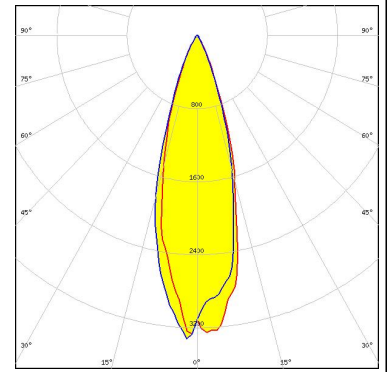

### STANLEY

LED FWR1108MS  
 FWHM / FWTM 35.0° / 51.0°  
 Efficiency 90 %  
 LEDs/each optic 1  
 Light colour IR  
 Required components:

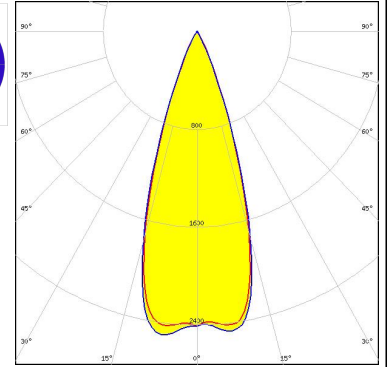
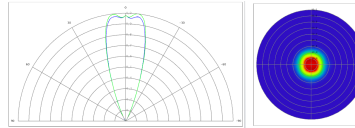

### STANLEY

LED MFN1108MS  
 FWHM / FWTM 33.0° / 47.0°  
 Efficiency 91 %  
 Peak intensity 3 cd/lm  
 LEDs/each optic 1  
 Light colour IR  
 Required components:

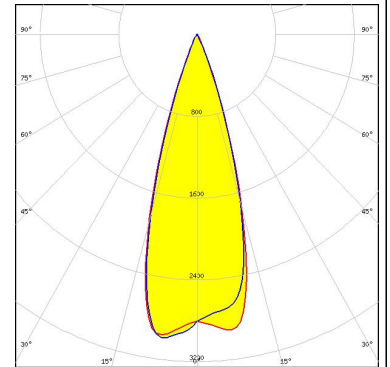

### STANLEY

LED MGN1108MS  
 FWHM / FWTM 33.0° / 47.0°  
 Efficiency 91 %  
 Peak intensity 3 cd/lm  
 LEDs/each optic 1  
 Light colour IR  
 Required components:

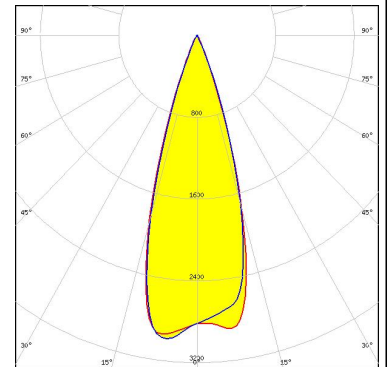

### OPTICAL RESULTS (SIMULATED):

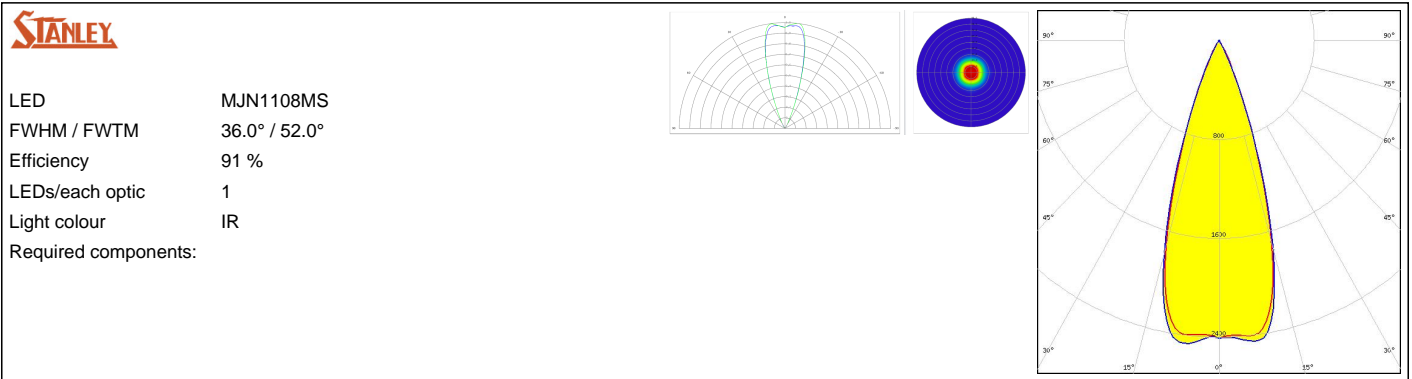

### GENERAL INFORMATION:

NOTE: The typical beam angle will be changed by different color, chip size and chip position tolerance. The typical total beam angle is the full angle measured where the luminous intensity is half of the peak value.

### MATERIALS:

As part of our continuous research and improvement processes, and to ensure the best possible quality and availability of our products, LEDiL reserves the right to change material grades without notice.

### PRODUCT DATA USER AGREEMENT AND DISCLAIMER:

The measured data in the provided downloadable LEDiL Product Datasheets and Mechanical 2D-Drawings is rounded and provided as reference for planning. LEDiL Oy's optical specifications have been verified by conducting performance testing of the products in accordance with the company's quality system. The reported data are averaged results of multiple measurements with typical variation. LEDiL Oy reserves the right to without prior notification make changes and improvements to its products.

LEDiL Oy assumes neither warranty, nor guarantee nor any other liability of any kind for the contents and correctness of the provided data. The provided data has been generated with highest diligence but the provided data may in reality not represent the complete possible variation range of all intrinsic parameters. Therefore, in certain cases a deviation from the provided data could occur.

LEDiL Oy reserves the right to undertake technical changes of its products without further notification which could lead to changes in the provided data. LEDiL Oy assumes no liability of any kind for the possible deviation from any provided data or any other damage resulting from the usage of the provided data.

The user agrees to this disclaimer and user agreement with the download or usage of the provided files.

#### LEDiL Oy

Joensuunkatu 13  
FI-24240 SALO  
Finland

#### LEDiL Inc.

228 West Page Street  
Suite D  
Sycamore IL 60178  
USA

#### Ledil Optics Technology (Shenzhen) Co., Ltd.

# 405 , Block B  
Casic Motor Building  
Shenzhen 518057  
P.R.CHINA

#### Local sales and technical support

[www.ledil.com/  
where\\_to\\_buy](http://www.ledil.com/where_to_buy)

#### Shipping locations

Salo, Finland  
Hong Kong, China

#### Distribution Partners

[www.ledil.com/  
where\\_to\\_buy](http://www.ledil.com/where_to_buy)