

ASMT-UxB5-Nxxxxx

Surface Mount LED Indicator

Overview

This Broadcom[®] family of SMT LEDs is packaged in the industry-standard PLCC-2 package. These SMT LEDs have high reliability performance and are designed to work under a wide range of environmental conditions. This high reliability feature makes them ideally suited to be used as interior signs application conditions.

These LEDs are compatible with reflow soldering process.

The wide viewing angle at 120° makes these LEDs ideally suited for panel, push button, office equipment, industrial equipment, and home appliances. The flat top emitting surface makes it easy for these LEDs to mate with light pipes. With the built-in reflector pushing up the intensity of the light output, these LEDs are also suitable to be used as LED pixels in interior electronic signs.

Features

- Industry-standard PLCC-2 package
- High reliability LED package
- High brightness using InGaN dice technologies
- Super wide viewing angle at 120°
- Available in 8 mm carrier tape on 7 inch reel
- Stable and consistent performance with minimum degradation with silicone encapsulation
- Compatible with IR soldering process
- JEDEC MSL3

Applications

- Electronic signs and signals
 - Interior full color sign
 - Variable message sign
- Office automations, home appliances, industrial equipment
 - Front panel backlighting
 - Push button backlighting
 - Display backlighting

CAUTION! This LED is ESD sensitive. Please observe appropriate precautions during handling and processing. Refer to Broadcom Application Note AN-1142 for additional details.

Package Drawing

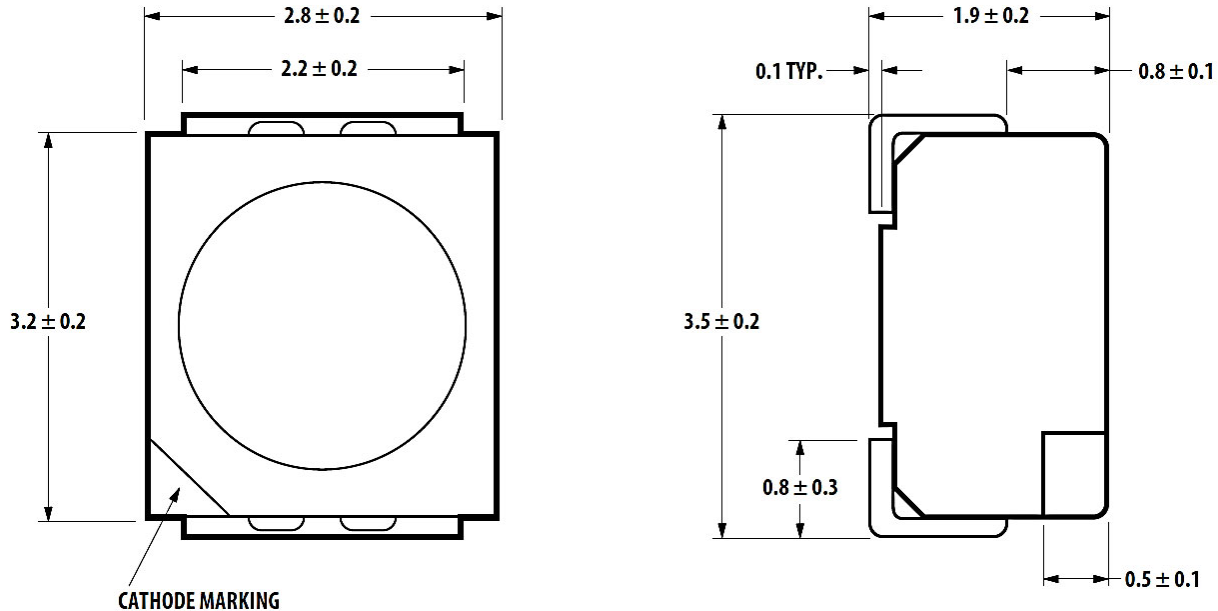

NOTE:

1. All dimensions in millimeters (mm).
2. Tolerance is ± 0.20 mm unless otherwise specified.
3. Encapsulation = silicone.
4. Terminal finish = silver plating.

Device Selection Guide ($T_J = 25^\circ\text{C}$, $I_F = 20$ mA)

Color	Part Number	Luminous Intensity, I_V (mcd) ^{a, b}		Test Current (mA)	Die Technology
		Min.	Max.		
Blue	ASMT-UBB5-NS7Q2	224.00	450.00	20	InGaN
Blue	ASMT-UBB5-NS7P2	224.00	450.00	20	InGaN
Blue	ASMT-UBB5-NS7Y2	224.00	450.00	20	InGaN
Blue	ASMT-UBB5-NS8Q2	224.00	560.00	20	InGaN
Blue	ASMT-UBB5-NT3Q2	285.00	560.00	20	InGaN
Blue	ASMT-UBB5-NT3P2	285.00	560.00	20	InGaN
Blue	ASMT-UBB5-NT3Y2	285.00	560.00	20	InGaN
Green	ASMT-UGB5-NW7Q2	1400.00	2850.00	20	InGaN
Green	ASMT-UGB5-NW7P2	1400.00	2850.00	20	InGaN
Green	ASMT-UGB5-NW7Y2	1400.00	2850.00	20	InGaN

a. The luminous intensity I_V is measured at the mechanical axis of the lamp package. The actual peak of the spatial radiation pattern might not be aligned with this axis.

b. Tolerance is $\pm 12\%$.

Absolute Maximum Ratings

Parameters	ASMT-UxB5-N	Unit
DC Forward Current ^{a, b}	30	mA
Peak Forward Current ^c	100	mA
Power Dissipation	114	mW
Reverse Voltage ^d	4	V
LED Junction Temperature	110	°C
Operating Temperature Range	-40 to +100	°C
Storage Temperature Range	-40 to +100	°C

- a. Derate linearly as shown in [Figure 4](#).
- b. Operation at current below 5 mA is not recommended.
- c. Duty factor = 10%, frequency = 1 kHz.
- d. Operation at reverse voltage is not recommended. Driving the LED in reverse direction is suitable for short-term application only.

Optical and Electrical Characteristics (T_J = 25°C, I_F = 20 mA)

Parameters	Min.	Typ.	Max.	Unit
Viewing Angle, 2θ _{1/2} ^a	—	120	—	°
Forward Voltage, V _F ^b	2.7	—	4.10	V
Reverse Voltage, V _R at I _R = 10 μA ^c	4	—	—	V
Thermal Resistance, R _{θJ-S} ^d	—	280	—	°C/W

- a. θ_{1/2} is the off-axis angle where the luminous intensity is half of the peak intensity.
- b. Forward voltage tolerance is ±0.1V.
- c. Indicates product final test condition only. Long-term reverse bias is not recommended.
- d. Thermal resistance from LED junction to solder pint.

Part Numbering System

A S M T - U X₁ B 5 - N X₂ X₃ X₄ X₅

Code	Description	Option	
X ₁	LED Color	B	Blue
		G	Green
X ₂	Minimum Intensity Bin	Refer to Intensity Bin Limits (CAT) table.	
X ₃	Intensity Bin Selection	0	Full Distribution
		2	2 half bins starting from X ₂ 1
		3	3 half bins starting from X ₂ 1
		4	4 half bins starting from X ₂ 1
		5	5 half bins starting from X ₂ 1
		6	2 half bins starting from X ₂ 2
		7	3 half bins starting from X ₂ 2
		8	4 half bins starting from X ₂ 2
		9	5 half bins starting from X ₂ 2
X ₄	Color Bin Selection	0	Full Distribution
		Z	A and B only
		Y	B and C only
		W	C and D only
		V	D and E only
		U	E and F only
		T	F and G only
		S	G and H only
		Q	A, B, and C only
		P	B, C, and D only
		N	C, D, and E only
		M	D, E, and F only
		L	E, F, and G only
K	F, G, and H only		
X ₅	Packaging Option	2	20 mA test current, Top mount, 7 inch reel size

Bin Information

Intensity Bin Limits (CAT)

Bin ID	Luminous Intensity, I _v (mcd)	
	Min.	Max.
S1	180.00	224.00
S2	224.00	285.00
T1	285.00	355.00
T2	355.00	450.00
U1	450.00	560.00
U2	560.00	715.00
V1	715.00	900.00
V2	900.00	1125.00
W1	1125.00	1400.00
W2	1400.00	1800.00
X1	1800.00	2240.00
X2	2240.00	2850.00

Tolerance = ±12%.

Figure 1: Spectral Power Distribution

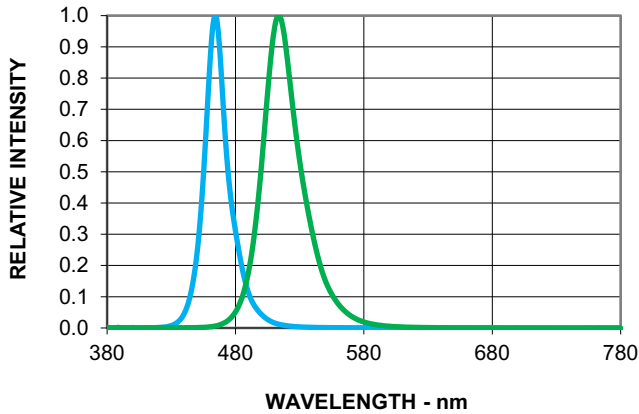

Color Bin Limits (BIN)

Blue	Dominant Wavelength, DW (nm)	
	Min.	Max.
A	460.0	465.0
B	465.0	470.0
C	470.0	475.0
D	475.0	480.0

Green	Dominant Wavelength, DW (nm)	
	Min.	Max.
A	515.0	520.0
B	520.0	525.0
C	525.0	530.0
D	530.0	535.0

Tolerance = ±1 nm.

Figure 2: Forward Current vs. Forward Voltage

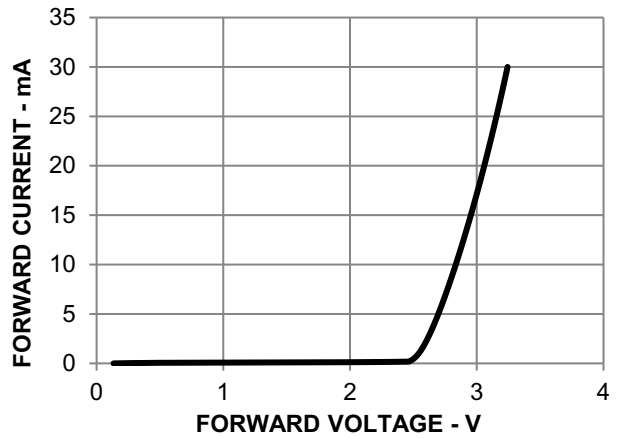

Figure 3: Relative Luminous Intensity vs. Mono Pulse Current

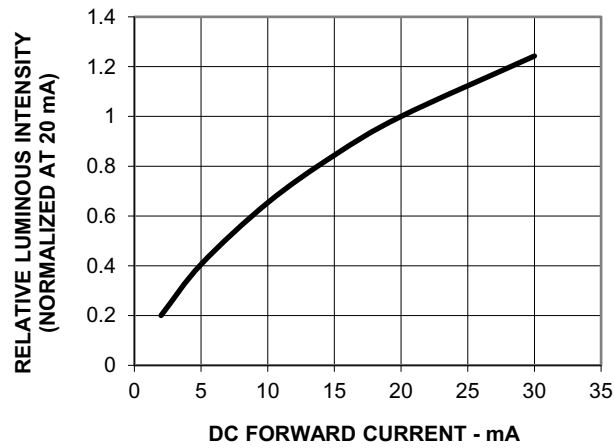

Figure 6: Radiation Pattern

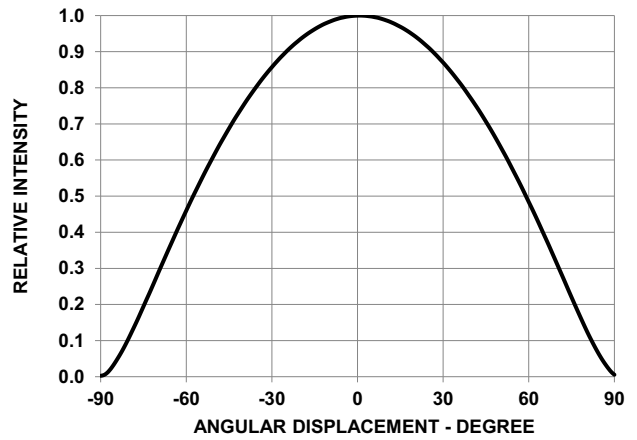

Figure 4: Maximum Forward Current vs. Ambient Temperature. Derated based on $T_{JMAX} = 110^{\circ}C$

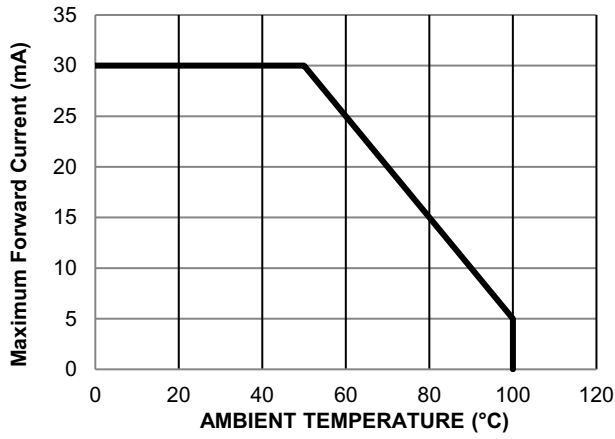
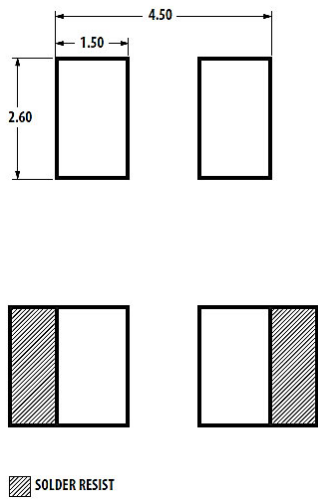

Figure 5: Recommended Soldering Land Pattern



Precautionary Notes

Soldering

- Do not perform reflow soldering more than twice. Observe necessary precautions of handling moisture-sensitive device as stated in the following section.
- Do not apply any pressure or force on the LED during reflow and after reflow when the LED is still hot.
- Use reflow soldering to solder the LED. Use hand soldering only for rework if unavoidable, but it must be strictly controlled to following conditions:
 - Soldering iron tip temperature = 315°C max.
 - Soldering duration = 3 sec max.
 - Number of cycles = 1 only.
 - Power of soldering iron = 50W max.
- Do not touch the LED package body with the soldering iron except for the soldering terminals, as it might cause damage to the LED.
- Confirm beforehand whether the functionality and performance of the LED is affected by soldering with hand soldering.

Figure 10: Recommended Lead-Free Reflow Soldering Profile

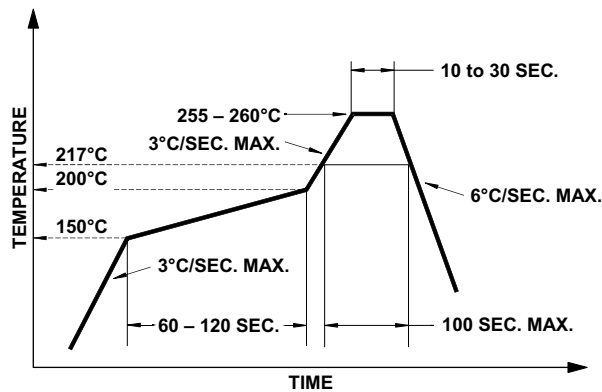
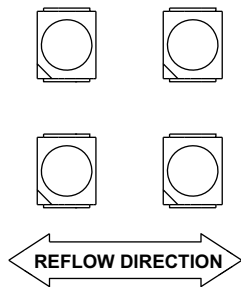

Figure 11: Recommended Board Reflow Direction



Handling Precautions

The encapsulation material of the LED is made of silicone for better product reliability. Compared to epoxy encapsulant, which is hard and brittle, silicone is softer and flexible. Observe special handling precautions during assembly of silicone encapsulated LED products. Failure to comply might lead to damage and premature failure of the LED. Refer to Broadcom Application Note AN5288, *Silicone Encapsulation for LED: Advantages and Handling Precautions*, for additional information.

- Do not poke sharp objects into the silicone encapsulant. Sharp objects, such as tweezers or syringes, might apply excessive force or even pierce through the silicone and induce failures to the LED die or wire bond.
- Do not touch the silicone encapsulant. Uncontrolled force acting on the silicone encapsulant might result in excessive stress on the wire bond. Hold the LED only by the body.
- Do not stack assembled PCBs together. Use an appropriate rack to hold the PCBs.
- Surface of silicone material attracts dust and dirt easier than epoxy due to its surface tackiness. To remove foreign particles on the surface of silicone, use a cotton bud with isopropyl alcohol (IPA). During cleaning, rub the surface gently without putting too much pressure on the silicone. Ultrasonic cleaning is not recommended.
- For automated pick and place, Broadcom has tested a nozzle size with OD 1.5 mm to work with this LED. However, due to the possibility of variations in other parameters such as pick and place machine maker/model, and other settings of the machine, verify that the selected nozzle will not cause damage to the LED.

Handling of Moisture-Sensitive Devices

This product has a Moisture Sensitive Level 3 rating per JEDEC J-STD-020. Refer to Broadcom Application Note AN5305, *Handling of Moisture Sensitive Surface Mount Devices*, for additional details and a review of proper handling procedures.

- Before use:
 - An unopened moisture barrier bag (MBB) can be stored at <40°C/90% RH for 12 months. If the actual shelf life has exceeded 12 months and the Humidity Indicator Card (HIC) indicates that baking is not required, then it is safe to reflow the LEDs per the original MSL rating.

- Do not open the MBB prior to assembly (for example, for IQC). If unavoidable, MBB must be properly resealed with fresh desiccant and HIC. The exposed duration must be taken in as floor life.
- Control after opening the MBB:
 - Read the HIC immediately upon opening of MBB.
 - Keep the LEDs at <30°/60%RH at all times, and complete all high temperature-related processes, including soldering, curing or rework within 168 hours.
- Control for unfinished reel:

Store unused LEDs in a sealed MBB with desiccant or a desiccator at <5% RH.
- Control of assembled boards:

If the PCB soldered with the LEDs is to be subjected to other high-temperature processes, store the PCB in a sealed MBB with desiccant or desiccator at <5% RH to ensure that all LEDs have not exceeded their floor life of 168 hours.
- Baking is required if:
 - The HIC indicator indicates a change in color for 10% and 5%, as stated on the HIC.
 - The LEDs are exposed to conditions of >30°C/60% RH at any time.
 - The LED's floor life exceeded 168 hours.

The recommended baking condition is: 60 ± 5°C for 20 hours.

Baking can only be done once.
- Storage:

The soldering terminals of these Broadcom LEDs are silver plated. If the LEDs are exposed in ambient environment for too long, the silver plating might be oxidized, thus affecting its solderability performance. As such, keep unused LEDs in a sealed MBB with desiccant or in a desiccator at <5% RH.

Application Precautions

- The drive current of the LED must not exceed the maximum allowable limit across temperature as stated in the data sheet. Constant current driving is recommended to ensure consistent performance.
- Circuit design must cater to the whole range of forward voltage (V_F) of the LEDs to ensure the intended drive current can always be achieved.
- The LED exhibits slightly different characteristics at different drive currents, which might result in a larger variation of performance (that is, intensity, wavelength,

and forward voltage). Set the application current as close as possible to the test current to minimize these variations.

- Do not use the LED in the vicinity of material with sulfur content or in environments of high gaseous sulfur compounds and corrosive elements. Examples of material that might contain sulfur are rubber gaskets, room-temperature vulcanizing (RTV) silicone rubber, rubber gloves, and so on. Prolonged exposure to such environments can affect the optical characteristics and product life.
- White LEDs must not be exposed to acidic environments and must not be used in the vicinity of any compound that might have acidic outgas, such as, but not limited to, acrylate adhesive. These environments have an adverse effect on LED performance.
- Avoid rapid change in ambient temperature, especially in high-humidity environments, because they cause condensation on the LED.
- If the LED is intended to be used in harsh or outdoor environment, protect the LED against damages caused by rain water, water, dust, oil, corrosive gases, external mechanical stresses, and so on.

Thermal Management

The optical, electrical, and reliability characteristics of the LED are affected by temperature. Keep the junction temperature (T_J) of the LED below the allowable limit at all times. T_J can be calculated as follows:

$$T_J = T_A + R_{\theta J-A} \times I_F \times V_{Fmax}$$

where:

T_A = ambient temperature (°C)

$R_{\theta J-A}$ = thermal resistance from LED junction to ambient (°C/W)

I_F = forward current (A)

V_{Fmax} = maximum forward voltage (V)

The complication of using this formula lies in T_A and $R_{\theta J-A}$. Actual T_A is sometimes subjective and hard to determine. $R_{\theta J-A}$ varies from system to system depending on design and is usually not known.

Another way of calculating T_J is by using the solder point temperature, T_S as follows:

$$T_J = T_S + R_{\theta J-S} \times I_F \times V_{Fmax}$$

where:

T_S = LED solder point temperature as shown in the following figure ($^{\circ}\text{C}$)

$R_{\theta J-S}$ = thermal resistance from junction to solder point ($^{\circ}\text{C}/\text{W}$)

I_F = forward current (A)

V_{Fmax} = maximum forward voltage (V)

Figure 12: Solder Point Temperature on PCB

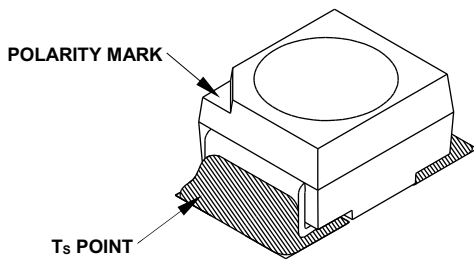

T_S can be easily measured by mounting a thermocouple on the soldering joint as shown in preceding figure, while $R_{\theta J-S}$ is provided in the data sheet. Verify the T_S of the LED in the final product to ensure that the LEDs are operating within all maximum ratings stated in the data sheet.

Eye Safety Precautions

LEDs can pose optical hazards when in operation. Do not look directly at operating LEDs because it might be harmful to the eyes. For safety reasons, use appropriate shielding or personal protective equipment.

Disclaimer

Broadcom's products and software are not specifically designed, manufactured, or authorized for sale as parts, components, or assemblies for the planning, construction, maintenance, or direct operation of a nuclear facility or for use in medical devices or applications. The customer is solely responsible, and waives all rights to make claims against Broadcom or its suppliers, for all loss, damage, expense, or liability in connection with such use.

Broadcom, the pulse logo, Connecting everything, Avago Technologies, Avago, and the A logo are among the trademarks of Broadcom and/or its affiliates in the United States, certain other countries, and/or the EU.

Copyright © 2019 Broadcom. All Rights Reserved.

The term "Broadcom" refers to Broadcom Inc. and/or its subsidiaries. For more information, please visit www.broadcom.com.

Broadcom reserves the right to make changes without further notice to any products or data herein to improve reliability, function, or design. Information furnished by Broadcom is believed to be accurate and reliable. However, Broadcom does not assume any liability arising out of the application or use of this information, nor the application or use of any product or circuit described herein, neither does it convey any license under its patent rights nor the rights of others.

