



**LEOPARD**  
IMAGING

# LI-IMX490-FPDLINKII-xxxH



**Address:**

910 Auburn Ct  
Fremont, CA 94538  
USA



**Phone:**

+1 (408)263-0988

**Fax:**

+1 (408)217-1960



**Sales:**

[sales@leopardimaging.com](mailto:sales@leopardimaging.com)

**Support:**

[support@leopardimaging.com](mailto:support@leopardimaging.com)

## INTRODUCTION

The LI-IMX490-FPDLINKIII-xxxH is equipped with Sony automotive sensor IMX490 and FPD-Link III serializer TI953 and is designed for automotive applications. This camera outputs RAW image data and supports HDR (High Dynamic Range) function.

## KEY FEATURES

Sensor	Sony Diagonal 10.36 mm (Type 1/1.55) CMOS Image Sensor IMX490
Optical Format	1/1.55"
Resolution	2897 (H) x 1877 (V) (active pixels)
Pixel Size	3.0 x 3.0 $\mu\text{m}$
Data Format	20-bit / 16-bit / 14-bit / 12-bit RAW
Color / Mono	Color sensor
Maximum Frame Rate	40 fps @ 2880 x 1860
HDR (High Dynamic Range)	Supported
LFM (LED Flicker Mitigation)	Supported
Lens	FOV H 30° / 40° / 65° / 90°
Serializer	TI953 FPD-Link III (DS90UB953-Q1)
Power Supply Range	TBD
Connector	FAKRA Z TYPE
IP Rating	FOV H 30°: IP69K FOV H 40° / 65° / 90°: IP67
Power Consumption	< 120 mA @ 12 VDC
Operating Temp	-40°C ~ +85°C
Storage Temp	-40°C ~ +125°C
Weight	~ 55 g
Part#	LI-IMX490-FPDLINKIII-xxxH

## APPLICATIONS

- Automotive ADAS
- Automotive Rear View or Backup

## IMAGE ORIENTATION

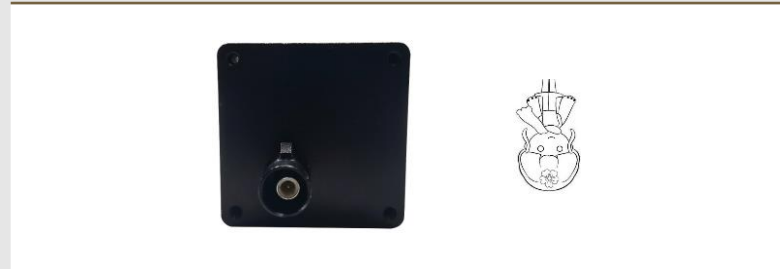

## CABLE CONNECTOR

- Housing Connector: FAKRA Z Type
- Cable Length: 3 meters
- Cable Part#: FAK-SMZSMZ-3M

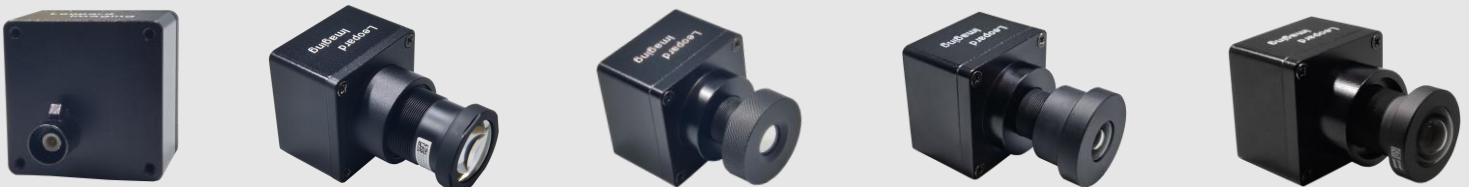

### DIMENSIONS: LI-IMX490-FPDLINKIII-030H

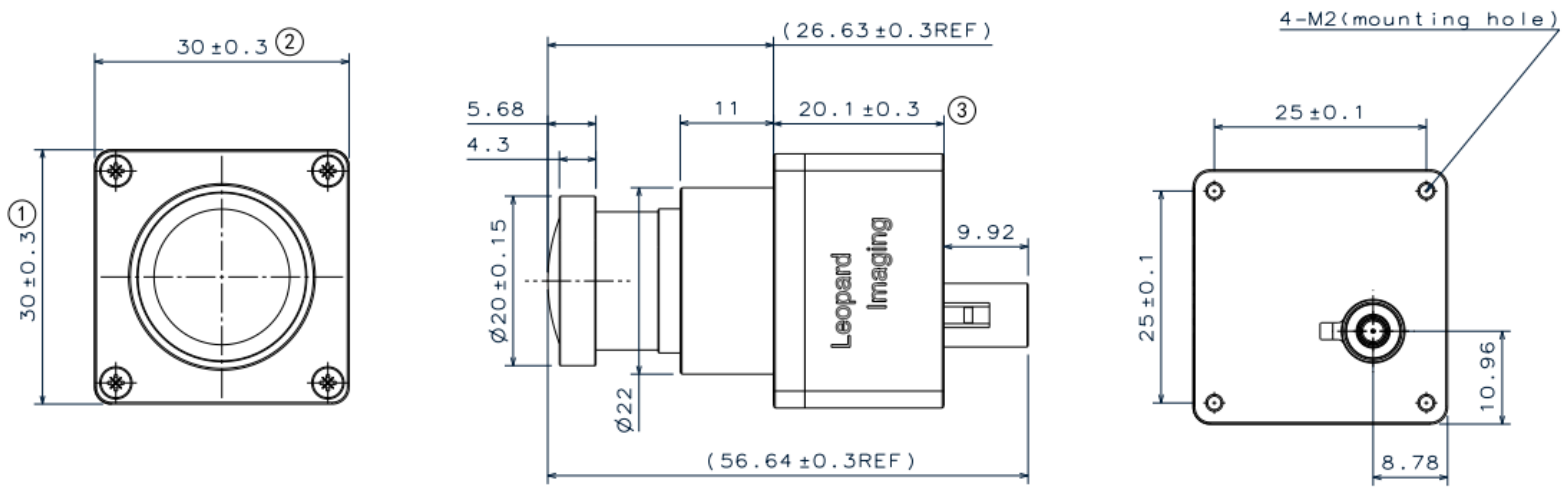

**NOTE:**

- $\otimes$  marked are important sizes.
- Tolerances for others unmarked are  $\pm 0.3$  mm.

Unit: mm

### DIMENSIONS: LI-IMX490-FPDLINKIII-040H

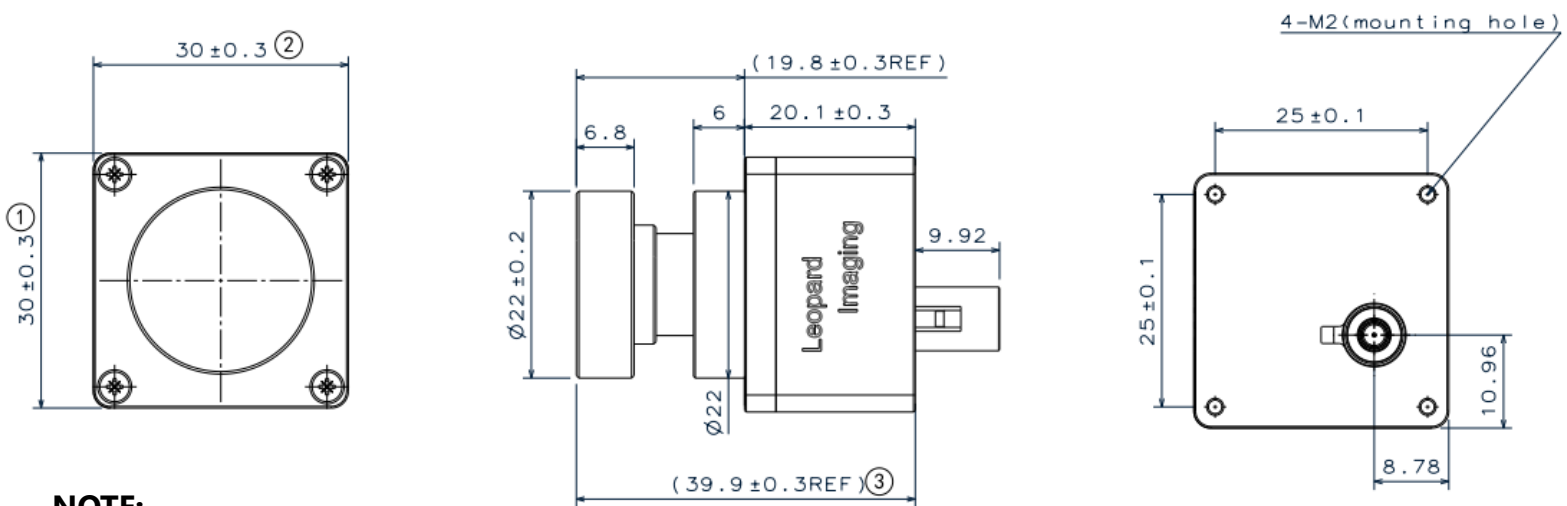

**NOTE:**

- $\otimes$  marked are important sizes.
- Tolerances for others unmarked are  $\pm 0.3$  mm.

Unit: mm

### DIMENSIONS: LI-IMX490-FPDLINKIII-065H

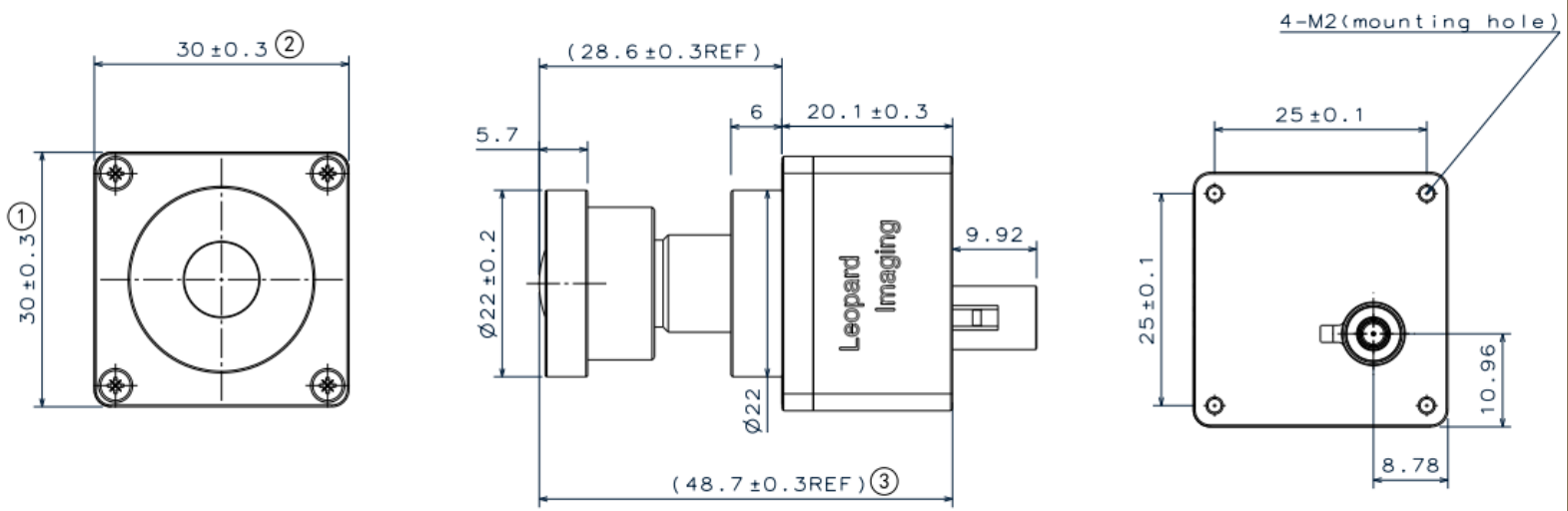

#### NOTE:

- $\otimes$  marked are important sizes.
- Tolerances for others unmarked are  $\pm 0.3$  mm.

Unit: mm

### DIMENSIONS: LI-IMX490-FPDLINKIII-090H

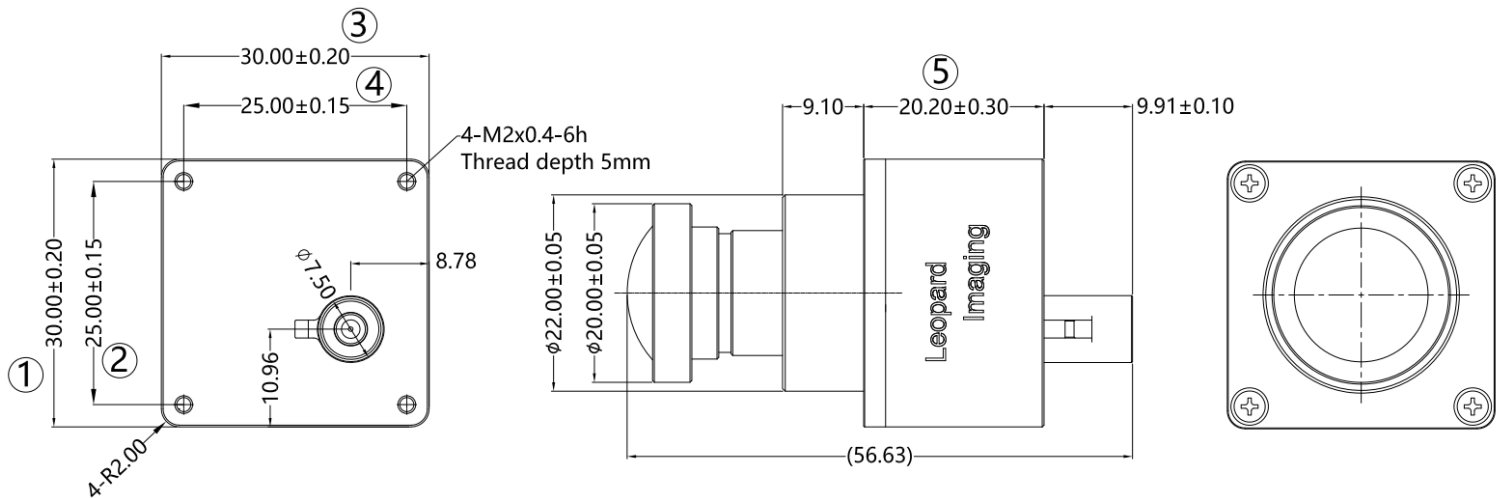

#### NOTE:

- $\otimes$  marked are important sizes.
- Tolerances for others unmarked are  $\pm 0.3$  mm.

Unit: mm

## LENS SPECIFICATIONS

xxxH refers to 030H (FOV H 30°), 040H (FOV H 40°), 065H (FOV H 65°), and 090H (FOV H 90°)

LI-IMX490-FPDLINKIII-030H	LI-IMX490-FPDLINKIII-040H
	
Lens EFL: 16.37 mm	Lens EFL: 11.9 mm
Aperture, F/#: 1.6	Aperture, F/#: 2.0
Field of View (FOV): 35.5° (D) / 30.0° (H) / 19.5° (V)	Field of View (FOV): 44.4° (D) / 38.0° (H) / 20.8° (V)
Mount: M17	Mount: M12

LI-IMX490-FPDLINKIII-065H	LI-IMX490-FPDLINKIII-090H
	
Lens EFL: 7.9 mm	Lens EFL: 5.39 mm
Aperture, F/#: 2.0	Aperture, F/#: 2.6
Field of View (FOV): 74.0° (D) / 65.0° (H) / 37.0° (V)	Field of View (FOV): 90° (H)
Mount: M12	Mount: M14

# PINOUT CONNECTIONS

(I2C: 0x1A 7-bit)

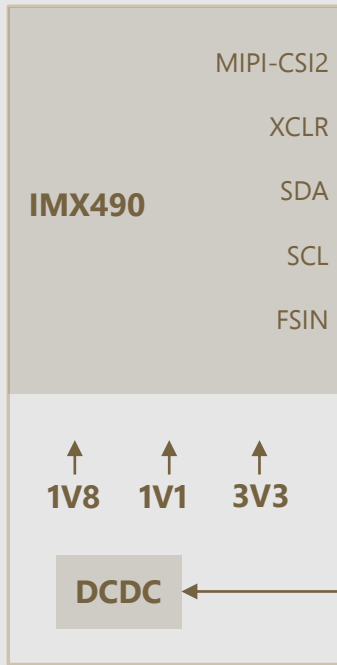

(I2C: 0x30 8-bit)

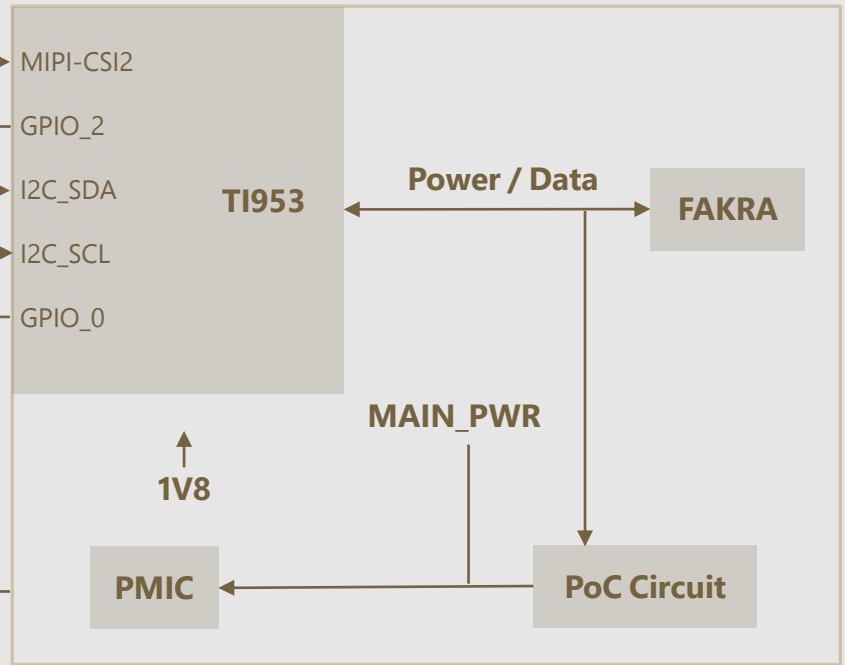

## USB3.0 CAMERA KIT

LI-FPDLINKIII-USB

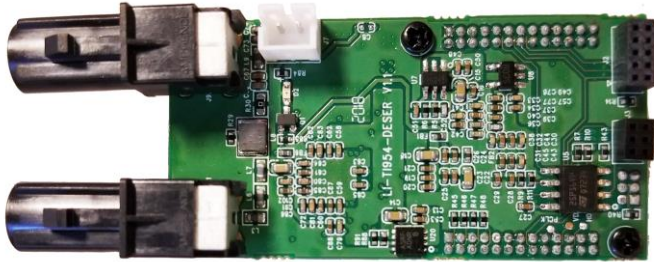

Top View



Bottom View

LI-IMX490-FPDLINKIII-xxxH can connect to LI-FPDLINKIII-USB as a USB 3.0 camera.

Part#: **LI-USB30-IMX490-FPDLINKIII-xxxH**

### SPECIFICATIONS

- USB 3.0 Super Speed support
- RAW data output without compression
- UVC compliant
- Allows customization
- 12 VDC power supply for camera
- Weight: ~ 86 g
- Single Coax Cable transmits up to 12 meters PoC (Power over Cable)
- Resolution: 2896 x 1876 @ 10 fps
- Power consumption: < 120 mA @ 12 VDC
- Compatible with Windows, Linux, and other operating systems that have UVC drivers

### BOM

#	Items	QTY
1	LI-IMX490-FPDLINKIII-xxxH	1
2	LI-FPDLINKIII-USB	1
3	3-Meter Fakra Cable	1
4	12 VDC Power Supply	1
5	USB3.0 Cable	1



### SDK SUPPORTED

- Camera Tool Source Code in C#
- Capture & Display
- Register Access Function
- Save file as BMP & RAW format

## ● REVISION HISTORY

Revision	Description	Release Date
1.0	First release.	20 Aug 2019
1.1	Added DSL492 lens and updated the resolution to full size.	26 Aug 2019
1.2	Added 030H lens.	02 Aug 2019
1.3	Changed CAR-53 lens to CAR-55.	02 Jun 2021
1.4	<ol style="list-style-type: none"><li>1. Replaced CAR-36 with CAR-56 and added CAR-56 dimensions.</li><li>2. Replaced system and power block diagram with pinout connections diagram.</li></ol>	16 Mar 2022
1.5	Updated 090H lens to DSL332A.	04 Jan 2023
1.6	Deleted HDR function on the USB30 page.	07 Apr 2023
1.7	Updated IP rating of 090H lens.	19 Jun 2023
1.8	Updated image direction.	27 Dec 2023
1.9	Deleted 120H lens.	22 Jan 2024

910 Auburn Ct, Fremont, CA 94538, USA

Phone: +1-408-263-0988

Fax: +1-408-217-1960

Email: [sales@leopardimaging.com](mailto:sales@leopardimaging.com)

Website: [www.leopardimaging.com](http://www.leopardimaging.com)

