

ST 2,5-QUATTRO/2P - Feed-through terminal block



3040038

<https://www.phoenixcontact.com/us/products/3040038>

Please be informed that the data shown in this PDF document is generated from our online catalog. Please find the complete data in the user documentation. Our general terms of use for downloads are valid.



Feed-through terminal block, nom. voltage: 500 V, nominal current: 24 A, number of connections: 4, connection method: Spring-cage/plug-in connection, 1st level connection right, Rated cross section: 2.5 mm², cross section: 0.08 mm² - 4 mm², 1st level connection left, mounting type: NS 35/7,5, NS 35/15, color: gray

Your advantages

- The plug-in ST-COMBI spring-cage terminal block series combines the system advantages of the ST standard terminal block series with those of the COMBI plug-in system
- Tested for railway applications

Commercial data

Item number	3040038
Packing unit	50 pc
Minimum order quantity	50 pc
Sales key	BE02
Product key	BE2141
Catalog page	Page 309 (C-1-2019)
GTIN	4017918832636
Weight per piece (including packing)	8.78 g
Weight per piece (excluding packing)	8.78 g
Customs tariff number	85369010
Country of origin	DE

ST 2,5-QUATTRO/2P - Feed-through terminal block



3040038

<https://www.phoenixcontact.com/us/products/3040038>

Technical data

Notes

General	The max. load current must not be exceeded by the total current of all connected conductors. Current and voltage are determined by the plug used.
---------	--

General

Note	The max. load current must not be exceeded by the total current of all connected conductors. With a free-hanging connection, an insulating foil has to be placed between the plug connection and electrically conductive surfaces.
------	---

Product properties

Product type	Plug-in terminal block
Product family	ST
Area of application	Railway industry Machine building Plant engineering
Number of connections	4
Number of rows	1
Potentials	1

Insulation characteristics

Overvoltage category	III
Degree of pollution	3

Electrical properties

Rated surge voltage	6 kV
Maximum power dissipation for nominal condition	0.77 W

Connection data

Number of connections per level	4
Nominal cross section	2.5 mm ²

1st level connection right

Stripping length	8 mm ... 10 mm
Internal cylindrical gage	A3
Connection in acc. with standard	IEC 61984
Conductor cross section rigid	0.08 mm ² ... 4 mm ²
Cross section AWG	28 ... 12 (converted acc. to IEC)
Conductor cross section flexible	0.08 mm ² ... 2.5 mm ²
Conductor cross section, flexible [AWG]	28 ... 14 (converted acc. to IEC)
Conductor cross-section flexible (ferrule without plastic sleeve)	0.14 mm ² ... 2.5 mm ²
Flexible conductor cross section (ferrule with plastic sleeve)	0.14 mm ² ... 2.5 mm ²

ST 2,5-QUATTRO/2P - Feed-through terminal block



3040038

<https://www.phoenixcontact.com/us/products/3040038>

2 conductors with the same cross section, flexible, with TWIN ferrule with plastic sleeve	0.5 mm ²
Nominal current	24 A (observe derating)
Maximum load current	24 A (with 4 mm ² conductor cross section)
Nominal voltage	500 V
Nominal cross section	2.5 mm ²

Dimensions

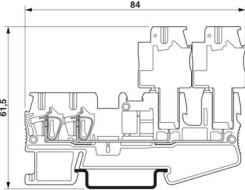
Dimensional drawing	
Width	5.2 mm
End cover width	2.2 mm
Height	81 mm
Depth on NS 35/7,5	36.5 mm
Depth on NS 35/15	44 mm

Material specifications

Color	gray
Flammability rating according to UL 94	V0
Insulating material group	I
Insulating material	PA
Static insulating material application in cold	-60 °C
Temperature index of insulation material (DIN EN 60216-1 (VDE 0304-21))	125 °C
Relative insulation material temperature index (Elec., UL 746 B)	130 °C
Fire protection for rail vehicles (DIN EN 45545-2) R22	HL 1 - HL 3
Fire protection for rail vehicles (DIN EN 45545-2) R23	HL 1 - HL 3
Fire protection for rail vehicles (DIN EN 45545-2) R24	HL 1 - HL 3
Fire protection for rail vehicles (DIN EN 45545-2) R26	HL 1 - HL 3
Calorimetric heat release NFPA 130 (ASTM E 1354)	27,5 MJ/kg
Surface flammability NFPA 130 (ASTM E 162)	passed
Specific optical density of smoke NFPA 130 (ASTM E 662)	passed
Smoke gas toxicity NFPA 130 (SMP 800C)	passed

Electrical tests

Surge voltage test

Test voltage setpoint	7.3 kV
Result	Test passed
Short-time withstand current 2.5 mm ²	0.3 kA
Result	Test passed

ST 2,5-QUATTRO/2P - Feed-through terminal block



3040038

<https://www.phoenixcontact.com/us/products/3040038>

Power-frequency withstand voltage

Test voltage setpoint	1.89 kV
Result	Test passed

Mechanical properties

Mechanical data

Open side panel	Yes
-----------------	-----

Mechanical tests

Attachment on the carrier

DIN rail/fixing support	NS 35
Test force setpoint	1 N
Result	Test passed

Environmental and real-life conditions

Needle-flame test

Time of exposure	30 s
Result	Test passed

Oscillation/broadband noise

Specification	DIN EN 50155 (VDE 0115-200):2022-06
Spectrum	Service life test category 1, class B, body mounted
Frequency	$f_1 = 5 \text{ Hz}$ to $f_2 = 150 \text{ Hz}$
ASD level	$0.964 \text{ (m/s}^2\text{)}^2\text{/Hz}$
Acceleration	0.58g
Test duration per axis	5 h
Test directions	X-, Y- and Z-axis
Result	Test passed

Shocks

Specification	DIN EN 50155 (VDE 0115-200):2008-03
Pulse shape	Half-sine
Acceleration	5g
Shock duration	30 ms
Number of shocks per direction	3
Test directions	X-, Y- and Z-axis (pos. and neg.)
Result	Test passed

Ambient conditions

Ambient temperature (operation)	-60 °C (max. operating temperature see derating curve)
Ambient temperature (storage/transport)	-25 °C ... 60 °C (for a short time, no longer than 24 h, -60°C to +70°C)
Ambient temperature (assembly)	-5 °C ... 70 °C
Ambient temperature (actuation)	-5 °C ... 70 °C

ST 2,5-QUATTRO/2P - Feed-through terminal block



3040038

<https://www.phoenixcontact.com/us/products/3040038>

Permissible humidity (operation)	20 % ... 90 %
Permissible humidity (storage/transport)	30 % ... 70 %

Standards and regulations

Connection in acc. with standard	IEC 61984
----------------------------------	-----------

Mounting

Mounting type	NS 35/7,5
	NS 35/15

ST 2,5-QUATTRO/2P - Feed-through terminal block



3040038

<https://www.phoenixcontact.com/us/products/3040038>

Drawings

Diagram

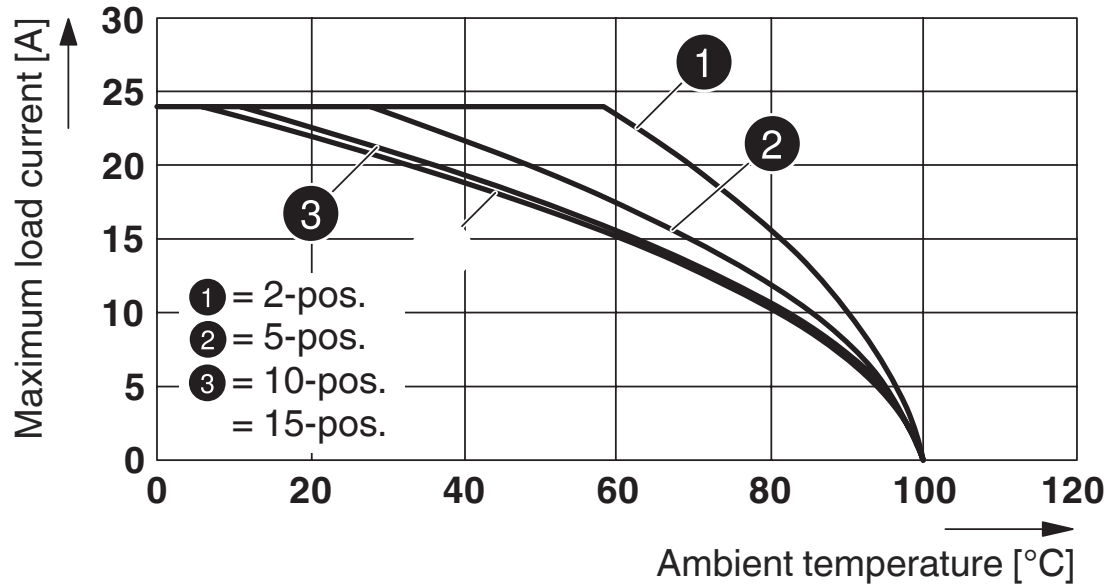

Applies to all male connector variants SP...

Circuit diagram

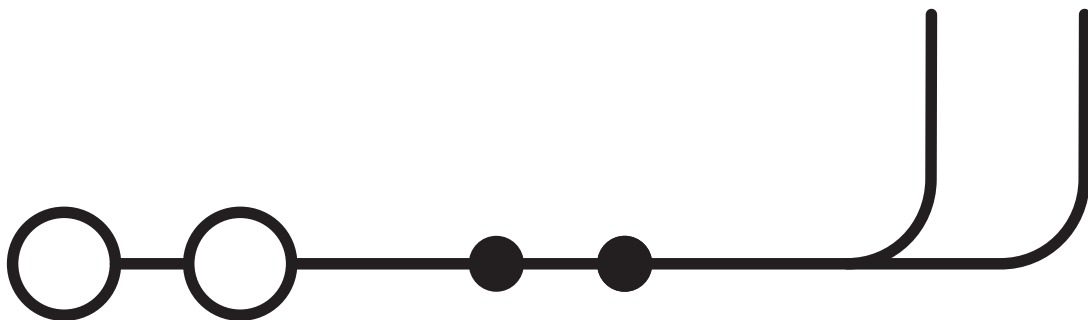

ST 2,5-QUATTRO/2P - Feed-through terminal block



3040038

<https://www.phoenixcontact.com/us/products/3040038>

Dimensional drawing

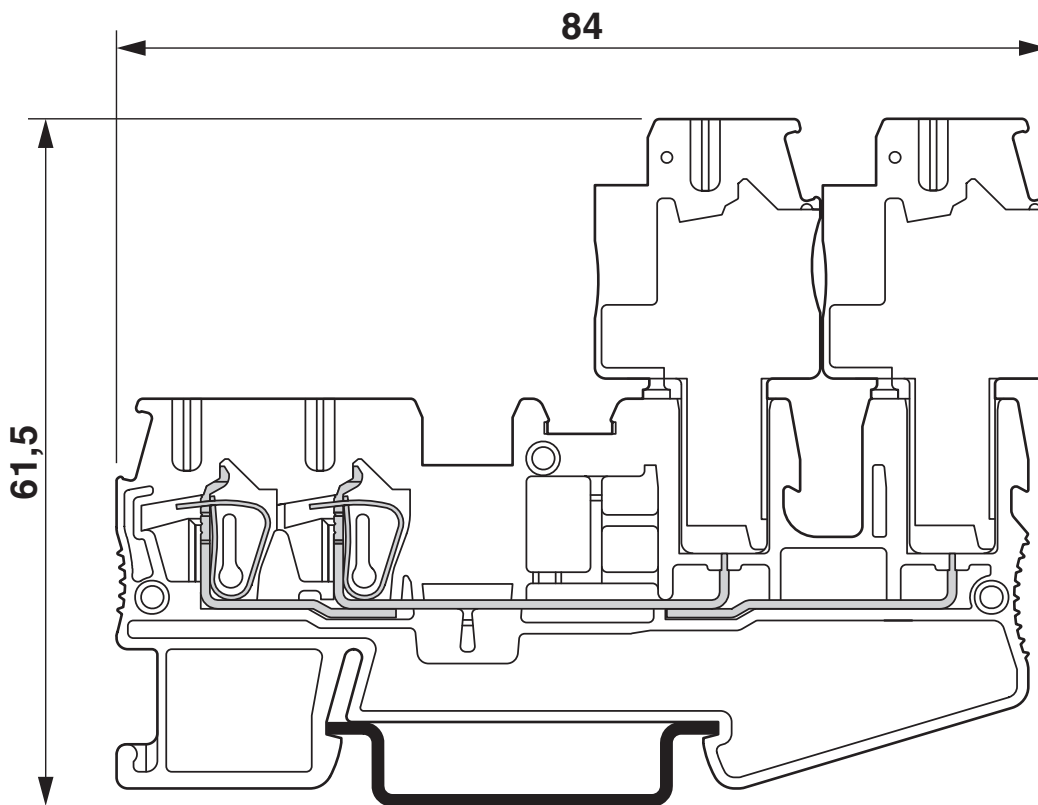

ST 2,5-QUATTRO/2P - Feed-through terminal block



3040038

<https://www.phoenixcontact.com/us/products/3040038>

Approvals

To download certificates, visit the product detail page: <https://www.phoenixcontact.com/us/products/3040038>

 CSA Approval ID: 13631				
	Nominal voltage U_N	Nominal current I_N	Cross section AWG	Cross section mm^2
Use group B	300 V	20 A	28 - 12	-
Use group C	300 V	20 A	28 - 12	-
Use group D	600 V	5 A	28 - 12	-

 IECEE CB Scheme Approval ID: DE1-62736/B1/B2				
--	--	--	--	--

 EAC Approval ID: RU C-DE.BL08.B.00644				
---	--	--	--	--

 cULus Recognized Approval ID: E60425				
	Nominal voltage U_N	Nominal current I_N	Cross section AWG	Cross section mm^2
Use group B	300 V	20 A	28 - 12	-
Use group C	300 V	20 A	28 - 12	-
Use group D	600 V	5 A	28 - 12	-
Use group F	500 V	20 A	28 - 12	-

 LR Approval ID: LR2042068TA				
---	--	--	--	--

 BV Approval ID: 27721/B0 BV				
---	--	--	--	--

 VDE Zeichengenehmigung Approval ID: 40019518				
--	--	--	--	--

ST 2,5-QUATTRO/2P - Feed-through terminal block



3040038

<https://www.phoenixcontact.com/us/products/3040038>

	Nominal voltage U_N	Nominal current I_N	Cross section AWG	Cross section mm^2
Only flexible conductors	500 V	-	-	0.2 - 2.5
Only rigid conductors	500 V	-	-	0.2 - 4

DNV

Approval ID: TAE00001CS

ST 2,5-QUATTRO/2P - Feed-through terminal block



3040038

<https://www.phoenixcontact.com/us/products/3040038>

Classifications

ECLASS

ECLASS-11.0	27141120
ECLASS-13.0	27250117

ETIM

ETIM 9.0	EC000897
----------	----------

UNSPSC

UNSPSC 21.0	39121400
-------------	----------

ST 2,5-QUATTRO/2P - Feed-through terminal block



3040038

<https://www.phoenixcontact.com/us/products/3040038>

Environmental product compliance

EU RoHS

Fulfills EU RoHS substance requirements	Yes, No exemptions
---	--------------------

China RoHS

Environment friendly use period (EFUP)	EFUP-E
	No hazardous substances above the limits

EU REACH SVHC

REACH candidate substance (CAS No.)	No substance above 0.1 wt%
-------------------------------------	----------------------------

ST 2,5-QUATTRO/2P - Feed-through terminal block



3040038

<https://www.phoenixcontact.com/us/products/3040038>

Accessories

i Note: Applying some accessories below might limit this product.

FBS 2-5 - Plug-in bridge

3030161

<https://www.phoenixcontact.com/us/products/3030161>



Plug-in bridge, pitch: 5.2 mm, number of positions: 2, length: 23 mm, color: red

i Max. current carrying capacity: 24 A

FBS 3-5 - Plug-in bridge

3030174

<https://www.phoenixcontact.com/us/products/3030174>



Plug-in bridge, pitch: 5.2 mm, number of positions: 3, length: 23 mm, color: red

i Max. current carrying capacity: 24 A

ST 2,5-QUATTRO/2P - Feed-through terminal block

3040038

<https://www.phoenixcontact.com/us/products/3040038>

FBS 4-5 - Plug-in bridge

3030187

<https://www.phoenixcontact.com/us/products/3030187>



Plug-in bridge, pitch: 5.2 mm, number of positions: 4, length: 23 mm, color: red

 Max. current carrying capacity: 24 A

FBS 5-5 - Plug-in bridge

3030190

<https://www.phoenixcontact.com/us/products/3030190>



Plug-in bridge, pitch: 5.2 mm, number of positions: 5, length: 23 mm, color: red

 Max. current carrying capacity: 24 A

ST 2,5-QUATTRO/2P - Feed-through terminal block



3040038

<https://www.phoenixcontact.com/us/products/3040038>

FBS 10-5 - Plug-in bridge

3030213

<https://www.phoenixcontact.com/us/products/3030213>



Plug-in bridge, pitch: 5.2 mm, number of positions: 10, length: 23 mm, color: red

 Max. current carrying capacity: 24 A

FBS 20-5 - Plug-in bridge

3030226

<https://www.phoenixcontact.com/us/products/3030226>



Plug-in bridge, pitch: 5.2 mm, number of positions: 20, color: red

 Max. current carrying capacity: 24 A

ST 2,5-QUATTRO/2P - Feed-through terminal block



3040038

<https://www.phoenixcontact.com/us/products/3040038>

FBS 50-5 - Plug-in bridge

3038930

<https://www.phoenixcontact.com/us/products/3038930>



Plug-in bridge, pitch: 5.2 mm, number of positions: 50, color: red

 Max. current carrying capacity: 24 A

FBS 2-5 BU - Plug-in bridge

3036877

<https://www.phoenixcontact.com/us/products/3036877>



Plug-in bridge, pitch: 5.2 mm, number of positions: 2, color: blue

 Max. current carrying capacity: 24 A

ST 2,5-QUATTRO/2P - Feed-through terminal block

3040038

<https://www.phoenixcontact.com/us/products/3040038>

FBS 3-5 BU - Plug-in bridge

3036880

<https://www.phoenixcontact.com/us/products/3036880>



Plug-in bridge, pitch: 5.2 mm, number of positions: 3, color: blue

 Max. current carrying capacity: 24 A

FBS 4-5 BU - Plug-in bridge

3036893

<https://www.phoenixcontact.com/us/products/3036893>



Plug-in bridge, pitch: 5.2 mm, number of positions: 4, color: blue

 Max. current carrying capacity: 24 A

ST 2,5-QUATTRO/2P - Feed-through terminal block

3040038

<https://www.phoenixcontact.com/us/products/3040038>

FBS 5-5 BU - Plug-in bridge

3036903

<https://www.phoenixcontact.com/us/products/3036903>



Plug-in bridge, pitch: 5.2 mm, number of positions: 5, color: blue

 Max. current carrying capacity: 24 A

FBS 10-5 BU - Plug-in bridge

3036916

<https://www.phoenixcontact.com/us/products/3036916>



Plug-in bridge, pitch: 5.2 mm, number of positions: 10, color: blue

 Max. current carrying capacity: 24 A

ST 2,5-QUATTRO/2P - Feed-through terminal block

3040038

<https://www.phoenixcontact.com/us/products/3040038>

FBS 20-5 BU - Plug-in bridge

3036929

<https://www.phoenixcontact.com/us/products/3036929>



Plug-in bridge, pitch: 5.2 mm, number of positions: 20, color: blue

 Max. current carrying capacity: 24 A

FBS 50-5 BU - Plug-in bridge

3032114

<https://www.phoenixcontact.com/us/products/3032114>



Plug-in bridge, pitch: 5.2 mm, number of positions: 50, color: blue

 Max. current carrying capacity: 24 A

ST 2,5-QUATTRO/2P - Feed-through terminal block

3040038

<https://www.phoenixcontact.com/us/products/3040038>

FBS 2-5 GY - Plug-in bridge

3038969

<https://www.phoenixcontact.com/us/products/3038969>



Plug-in bridge, pitch: 5.2 mm, number of positions: 2, color: gray

 Max. current carrying capacity: 24 A

FBS 3-5 GY - Plug-in bridge

3038972

<https://www.phoenixcontact.com/us/products/3038972>



Plug-in bridge, pitch: 5.2 mm, number of positions: 3, color: gray

 Max. current carrying capacity: 24 A

ST 2,5-QUATTRO/2P - Feed-through terminal block

3040038

<https://www.phoenixcontact.com/us/products/3040038>

FBS 4-5 GY - Plug-in bridge

3038985

<https://www.phoenixcontact.com/us/products/3038985>



Plug-in bridge, pitch: 5.2 mm, number of positions: 4, color: gray

 Max. current carrying capacity: 24 A

FBS 5-5 GY - Plug-in bridge

3038998

<https://www.phoenixcontact.com/us/products/3038998>



Plug-in bridge, pitch: 5.2 mm, number of positions: 5, color: gray

 Max. current carrying capacity: 24 A

ST 2,5-QUATTRO/2P - Feed-through terminal block

3040038

<https://www.phoenixcontact.com/us/products/3040038>

FBS 10-5 GY - Plug-in bridge

3039007

<https://www.phoenixcontact.com/us/products/3039007>



Plug-in bridge, pitch: 5.2 mm, number of positions: 10, color: gray

 Max. current carrying capacity: 24 A

FBS 20-5 GY - Plug-in bridge

3038671

<https://www.phoenixcontact.com/us/products/3038671>



Plug-in bridge, pitch: 5.2 mm, number of positions: 20, color: gray

 Max. current carrying capacity: 24 A

ST 2,5-QUATTRO/2P - Feed-through terminal block



3040038

<https://www.phoenixcontact.com/us/products/3040038>

FBS 50-5 GY - Plug-in bridge

3032127

<https://www.phoenixcontact.com/us/products/3032127>



Plug-in bridge, pitch: 5.2 mm, number of positions: 50, color: gray

 Max. current carrying capacity: 24 A

FBSR 2-5 - Plug-in bridge

3033702

<https://www.phoenixcontact.com/us/products/3033702>



Plug-in bridge, pitch: 5.2 mm, number of positions: 2, color: red

 Max. current carrying capacity: 17.5 A

ST 2,5-QUATTRO/2P - Feed-through terminal block

3040038

<https://www.phoenixcontact.com/us/products/3040038>

FBSR 3-5 - Plug-in bridge

3001591

<https://www.phoenixcontact.com/us/products/3001591>



Plug-in bridge, pitch: 5.2 mm, number of positions: 3, color: red

 Max. current carrying capacity: 17.5 A

FBSR 4-5 - Plug-in bridge

3001592

<https://www.phoenixcontact.com/us/products/3001592>



Plug-in bridge, pitch: 5.2 mm, number of positions: 4, color: red

 Max. current carrying capacity: 17.5 A

ST 2,5-QUATTRO/2P - Feed-through terminal block

3040038

<https://www.phoenixcontact.com/us/products/3040038>

FBSR 5-5 - Plug-in bridge

3001593

<https://www.phoenixcontact.com/us/products/3001593>



Plug-in bridge, pitch: 5.2 mm, number of positions: 5, color: red

 Max. current carrying capacity: 17.5 A

FBSR 10-5 - Plug-in bridge

3033710

<https://www.phoenixcontact.com/us/products/3033710>



Plug-in bridge, pitch: 5.2 mm, number of positions: 10, color: red

 Max. current carrying capacity: 17.5 A

ST 2,5-QUATTRO/2P - Feed-through terminal block



3040038

<https://www.phoenixcontact.com/us/products/3040038>

RB ST (2,5/4)-1,5/S - Reducing bridge

3214356

<https://www.phoenixcontact.com/us/products/3214356>



Reducing bridge, pitch: 6.7 mm, number of positions: 2, length: 23 mm, color: red

 Max. current carrying capacity: 24 A

RB ST 6-(2,5/4) - Reducing bridge

3030860

<https://www.phoenixcontact.com/us/products/3030860>



Reducing bridge, pitch: 9 mm, number of positions: 2, length: 30 mm, color: red

 Max. current carrying capacity: 35 A

ST 2,5-QUATTRO/2P - Feed-through terminal block

3040038

<https://www.phoenixcontact.com/us/products/3040038>

RB ST 10-(2,5/4) - Reducing bridge

3030873

<https://www.phoenixcontact.com/us/products/3030873>



Reducing bridge, pitch: 10 mm, number of positions: 2, length: 36 mm, color: red

 Max. current carrying capacity: 35 A

RB ST 16-(2,5/4) - Reducing bridge

3030886

<https://www.phoenixcontact.com/us/products/3030886>



Reducing bridge, pitch: 11 mm, number of positions: 2, length: 37 mm, color: red

 Max. current carrying capacity: 35 A

ST 2,5-QUATTRO/2P - Feed-through terminal block

3040038

<https://www.phoenixcontact.com/us/products/3040038>

RB ST 35-(2,5/4) - Reducing bridge

3030899

<https://www.phoenixcontact.com/us/products/3030899>



Reducing bridge, pitch: 11 mm, number of positions: 2, color: red

 Max. current carrying capacity: 35 A

RB ST (2,5/4)-1,5 - Reducing bridge

3038943

<https://www.phoenixcontact.com/us/products/3038943>



Reducing bridge, pitch: 7.1 mm, number of positions: 2, length: 23 mm, color: red

 Max. current carrying capacity: 24 A

ST 2,5-QUATTRO/2P - Feed-through terminal block



3040038

<https://www.phoenixcontact.com/us/products/3040038>

RB UT 6-ST(2,5/4) - Reducing bridge

3047264

<https://www.phoenixcontact.com/us/products/3047264>



Reducing bridge, pitch: 9.5 mm, number of positions: 2, length: 33 mm, color: red

 Max. current carrying capacity: 35 A

RB UT 35-ST(2,5/4) - Reducing bridge

3047280

<https://www.phoenixcontact.com/us/products/3047280>



Reducing bridge, pitch: 10.8 mm, number of positions: 2, color: red

 Max. current carrying capacity: 40 A

ST 2,5-QUATTRO/2P - Feed-through terminal block



3040038

<https://www.phoenixcontact.com/us/products/3040038>

RB UT 10-ST(2,5/4) - Reducing bridge

3047086

<https://www.phoenixcontact.com/us/products/3047086>



Reducing bridge, pitch: 10.2 mm, number of positions: 2, length: 33 mm, color: red

 Max. current carrying capacity: 40 A

RB UT 16-ST(2,5/4) - Reducing bridge

3047099

<https://www.phoenixcontact.com/us/products/3047099>



Reducing bridge, pitch: 11 mm, number of positions: 2, length: 41 mm, color: red

 Max. current carrying capacity: 40 A

ST 2,5-QUATTRO/2P - Feed-through terminal block



3040038

<https://www.phoenixcontact.com/us/products/3040038>

D-ST 2,5-QUATTRO/2P - End cover

3040083

<https://www.phoenixcontact.com/us/products/3040083>

End cover, depth: 36.5 mm, width: 2.2 mm, height: 81 mm, color: gray



ATP-ST QUATTRO - Partition plate

3030815

<https://www.phoenixcontact.com/us/products/3030815>

Partition plate, depth: 45 mm, width: 2 mm, height: 90.9 mm, color: gray



ST 2,5-QUATTRO/2P - Feed-through terminal block



3040038

<https://www.phoenixcontact.com/us/products/3040038>

PC - Coding star

3040588

<https://www.phoenixcontact.com/us/products/3040588>



Coding star, 4-section, depth: 6 mm, width: 3 mm, height: 3 mm, color: red

DS-ST 4/P - Cover segment

3043750

<https://www.phoenixcontact.com/us/products/3043750>



Cover segment, depth: 36.5 mm, height: 72 mm, color: gray

ST 2,5-QUATTRO/2P - Feed-through terminal block

3040038

<https://www.phoenixcontact.com/us/products/3040038>

WST 2,5 - Warning cover

3030941

<https://www.phoenixcontact.com/us/products/3030941>



Warning cover, 5-pos., for terminal width: 5.2 mm

CEC 2,5 - Filler plug

3062757

<https://www.phoenixcontact.com/us/products/3062757>

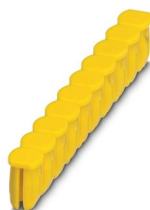

Cover for conductor shaft, 10-pos., for spring cage terminal blocks (ST) and terminal blocks with push-in technology (PT) with a width of 5.2 mm

ST 2,5-QUATTRO/2P - Feed-through terminal block

3040038

<https://www.phoenixcontact.com/us/products/3040038>



P-CO 2-5 R47K - Component connector

3032447

<https://www.phoenixcontact.com/us/products/3032447>



Component connector, with 47 kOhm resistance for wire-break monitoring, pitch: 5.2 mm, depth: 34.8 mm, width: 4.1 mm, height: 8.9 mm, number of positions: 2, color: black

LPO 2,5/E - Pick-off plug

3270516

<https://www.phoenixcontact.com/us/products/3270516>



Pick-off plug, nom. voltage: 800 V, nominal current: 24 A, number of positions: 1, connection method: Push-in connection, Rated cross section: 2.5 mm², cross section: 0.14 mm²- 4 mm², color: gray

ST 2,5-QUATTRO/2P - Feed-through terminal block



3040038

<https://www.phoenixcontact.com/us/products/3040038>

LPO 2,5 - Pick-off plug

3270517

<https://www.phoenixcontact.com/us/products/3270517>



Pick-off plug, nom. voltage: 800 V, nominal current: 24 A, number of positions: 1, connection method: Push-in connection, Rated cross section: 2.5 mm², cross section: 0.14 mm²- 4 mm², color: gray

LPS-5/E - Service connector

3270520

<https://www.phoenixcontact.com/us/products/3270520>



Service connector, nom. voltage: 800 V, nominal current: 24 A, number of positions: 1, connection method: Push-in connection, Rated cross section: 2.5 mm², cross section: 0.14 mm²- 4 mm², color: red

ST 2,5-QUATTRO/2P - Feed-through terminal block



3040038

<https://www.phoenixcontact.com/us/products/3040038>

LPS-5 - Service connector

3270521

<https://www.phoenixcontact.com/us/products/3270521>



Service connector, nom. voltage: 800 V, nominal current: 24 A, number of positions: 1, connection method: Push-in connection, Rated cross section: 2.5 mm², cross section: 0.14 mm²- 4 mm², color: red

NS 35/ 7,5 PERF 2000MM - DIN rail perforated

0801733

<https://www.phoenixcontact.com/us/products/0801733>



DIN rail perforated, Pack of 25 (50 m), acc. to EN 60715, material: Steel, galvanized, passivated with a thick layer, Standard profile, color: silver

ST 2,5-QUATTRO/2P - Feed-through terminal block

3040038

<https://www.phoenixcontact.com/us/products/3040038>



NS 35/ 7,5 UNPERF 2000MM - DIN rail, unperforated

0801681

<https://www.phoenixcontact.com/us/products/0801681>



DIN rail, unperforated, Pack of 25 (50 m), acc. to EN 60715, material: Steel, galvanized, passivated with a thick layer, Standard profile, color: silver

NS 35/ 7,5 WH PERF 2000MM - DIN rail perforated

1204119

<https://www.phoenixcontact.com/us/products/1204119>



DIN rail perforated, Pack of 25 (50 m), acc. to EN 60715, material: Steel, Galvanized, white passivated, Standard profile, color: silver

ST 2,5-QUATTRO/2P - Feed-through terminal block

3040038

<https://www.phoenixcontact.com/us/products/3040038>



NS 35/ 7,5 WH UNPERF 2000MM-VPE 10 - DIN rail, unperforated

1204122

<https://www.phoenixcontact.com/us/products/1204122>



DIN rail, unperforated, Pack of 10 (20 m), acc. to EN 60715, material: Steel, Galvanized, white passivated, Standard profile, color: silver

NS 35/ 7,5 AL UNPERF 2000MM - DIN rail, unperforated

0801704

<https://www.phoenixcontact.com/us/products/0801704>



DIN rail, unperforated, Pack of 25 (50 m), acc. to EN 60715, material: Aluminum, uncoated, Standard profile, color: silver

ST 2,5-QUATTRO/2P - Feed-through terminal block

3040038

<https://www.phoenixcontact.com/us/products/3040038>



NS 35/ 7,5 ZN PERF 2000MM - DIN rail perforated

1206421

<https://www.phoenixcontact.com/us/products/1206421>



DIN rail perforated, Pack of 25 (50 m), acc. to EN 60715, material: Steel, galvanized, Standard profile, color: silver

NS 35/ 7,5 ZN UNPERF 2000MM - DIN rail, unperforated

1206434

<https://www.phoenixcontact.com/us/products/1206434>



DIN rail, unperforated, Pack of 25 (50 m), acc. to EN 60715, material: Steel, galvanized, Standard profile, color: silver

ST 2,5-QUATTRO/2P - Feed-through terminal block

3040038

<https://www.phoenixcontact.com/us/products/3040038>



NS 35/ 7,5 CU UNPERF 2000MM-VPE 10 - DIN rail, unperforated

0801762

<https://www.phoenixcontact.com/us/products/0801762>



DIN rail, unperforated, Pack of 10 (20 m), acc. to EN 60715, material: Copper, uncoated, Standard profile, color: copper-colored

NS 35/ 7,5 CAP - End cap

1206560

<https://www.phoenixcontact.com/us/products/1206560>

DIN rail end piece, for DIN rail NS 35/7.5



ST 2,5-QUATTRO/2P - Feed-through terminal block



3040038

<https://www.phoenixcontact.com/us/products/3040038>

ZB 5 :UNBEDRUCKT - Zack marker strip

1050004

<https://www.phoenixcontact.com/us/products/1050004>



Zack marker strip, Strip, white, unlabeled, can be labeled with: PLOTMARK, CMS-P1-PLOTTER, mounting type: snapped, for terminal block width: 5.2 mm, lettering field size: 5.1 x 10.5 mm, Number of individual labels: 10

ZB 5 CUS - Zack marker strip

0824962

<https://www.phoenixcontact.com/us/products/0824962>



Zack marker strip, can be ordered: Strip, white, labeled according to customer specifications, mounting type: snap into tall marker groove, for terminal block width: 5.2 mm, lettering field size: 5.15 x 10.5 mm, Number of individual labels: 10

ST 2,5-QUATTRO/2P - Feed-through terminal block



3040038

<https://www.phoenixcontact.com/us/products/3040038>

ZB 5,LGS:FORTL.ZAHLEN - Zack marker strip

1050017

<https://www.phoenixcontact.com/us/products/1050017>



Zack marker strip, Strip, white, labeled, printed horizontally: consecutive numbers 1 ... 10, 11 ... 20, etc. up to 491 ... 500, mounting type: snapped, for terminal block width: 5.2 mm, lettering field size: 5.15 x 10.5 mm, Number of individual labels: 10

ZB 5,QR:FORTL.ZAHLEN - Zack marker strip

1050020

<https://www.phoenixcontact.com/us/products/1050020>



Zack marker strip, white, Printed vertically: consecutive numbers 1 ... 10, 11 ... 20, etc. up to 491 ... 500, mounting type: snapped, for terminal block width: 5.2 mm, lettering field size: 5.15 x 10.5 mm

ST 2,5-QUATTRO/2P - Feed-through terminal block



3040038

<https://www.phoenixcontact.com/us/products/3040038>

ZB 5,LGS:GLEICHE ZAHLEN - Zack marker strip

1050033

<https://www.phoenixcontact.com/us/products/1050033>



Zack marker strip, Strip, white, labeled, can be labeled with: CMS-P1-PLOTTER, printed horizontally: Identical numbers 1 or 2, etc. up to 100, mounting type: snapped, for terminal block width: 5.2 mm, lettering field size: 5.15 x 10.5 mm, Number of individual labels: 10

ZB 5,LGS:L1-N,PE - Zack marker strip

1050415

<https://www.phoenixcontact.com/us/products/1050415>



Zack marker strip, Strip, white, labeled, horizontal: L1, L2, L3, N, PE, L1, L2, L3, N, PE, mounting type: snapped, for terminal block width: 5.2 mm, lettering field size: 5.15 x 10.5 mm, Number of individual labels: 10

ST 2,5-QUATTRO/2P - Feed-through terminal block



3040038

<https://www.phoenixcontact.com/us/products/3040038>

UC-TM 5 - Marker for terminal blocks

0818108

<https://www.phoenixcontact.com/us/products/0818108>



Marker for terminal blocks, Sheet, white, unlabeled, can be labeled with: BLUEMARK ID COLOR, BLUEMARK ID, BLUEMARK CLED, PLOTMARK, CMS-P1-PLOTTER, mounting type: snapped, for terminal block width: 5.2 mm, lettering field size: 4.6 x 10.5 mm, Number of individual labels: 96

UC-TM 5 CUS - Marker for terminal blocks

0824581

<https://www.phoenixcontact.com/us/products/0824581>



Marker for terminal blocks, can be ordered: by sheet, white, labeled according to customer specifications, mounting type: snap into tall marker groove, for terminal block width: 5.2 mm, lettering field size: 10.5 x 4.6 mm, Number of individual labels: 96

ST 2,5-QUATTRO/2P - Feed-through terminal block



3040038

<https://www.phoenixcontact.com/us/products/3040038>

UCT-TM 5 - Marker for terminal blocks

0828734

<https://www.phoenixcontact.com/us/products/0828734>



Marker for terminal blocks, Sheet, white, unlabeled, can be labeled with: TOPMARK NEO, TOPMARK LASER, BLUEMARK ID COLOR, BLUEMARK ID, BLUEMARK CLED, THERMOMARK PRIME, THERMOMARK CARD 2.0, THERMOMARK CARD, mounting type: snapped, for terminal block width: 5.2 mm, lettering field size: 4.6 x 10.5 mm, Number of individual labels: 72

UCT-TM 5 CUS - Marker for terminal blocks

0829595

<https://www.phoenixcontact.com/us/products/0829595>



Marker for terminal blocks, can be ordered: by sheet, white, labeled according to customer specifications, mounting type: snap into tall marker groove, for terminal block width: 5.2 mm, lettering field size: 4.6 x 10.5 mm, Number of individual labels: 72

ST 2,5-QUATTRO/2P - Feed-through terminal block



3040038

<https://www.phoenixcontact.com/us/products/3040038>

GBS 5-25X12 - Group marker label for terminal marking

0810588

<https://www.phoenixcontact.com/us/products/0810588>



Group marker label, snaps onto terminal center for screw, spring-cage and quick connection terminal blocks, labeled with a 25 x 12 mm label or manually with the B-STIFT, in the foot part with ZB 5

GBS 5-25X5 - Group marker label for terminal marking

0829126

<https://www.phoenixcontact.com/us/products/0829126>



Group marking label, can be snapped into terminal center for screw, spring-cage, push-in, and fast connection terminal blocks, can be labeled with a 24 x 4 mm label or manually using B-STIFT, in the foot part with ZB 5

ST 2,5-QUATTRO/2P - Feed-through terminal block



3040038

<https://www.phoenixcontact.com/us/products/3040038>

STP 5-2-ZB - Marker carriers

3037643

<https://www.phoenixcontact.com/us/products/3037643>



Marker carriers, snaps into ST 2,5 spring-cage terminal blocks, can be marked with UC-TM 5, UC-TMF 5, UCT-TM 5, UCT-TMF 5, ZB 5, or ZBF 5, gray, unlabeled, mounting type: snapped

ZBF 5:UNBEDRUCKT - Zack Marker strip, flat

0808642

<https://www.phoenixcontact.com/us/products/0808642>



Zack Marker strip, flat, Strip, white, unlabeled, can be labeled with: PLOTMARK, CMS-P1-PLOTTER, mounting type: snapped, for terminal block width: 5 mm, lettering field size: 5.1 x 5.2 mm, Number of individual labels: 10

ST 2,5-QUATTRO/2P - Feed-through terminal block



3040038

<https://www.phoenixcontact.com/us/products/3040038>

ZBF 5 CUS - Zack Marker strip, flat

0825025

<https://www.phoenixcontact.com/us/products/0825025>



Zack Marker strip, flat, can be ordered: Strip, white, labeled according to customer specifications, mounting type: snap into flat marker groove, for terminal block width: 5 mm, lettering field size: 5.15 x 5.15 mm, Number of individual labels: 10

ZBF 5,LGS:FORTL.ZAHLEN - Zack Marker strip, flat

0808671

<https://www.phoenixcontact.com/us/products/0808671>



Zack Marker strip, flat, Strip, white, labeled, printed horizontally: consecutive numbers 1 ... 10, 11 ... 20, etc. up to 491 ... 500, mounting type: snapped, for terminal block width: 5 mm, lettering field size: 5.15 x 5.15 mm, Number of individual labels: 10

ST 2,5-QUATTRO/2P - Feed-through terminal block



3040038

<https://www.phoenixcontact.com/us/products/3040038>

ZBF 5,QR:FORTL.ZAHLEN - Zack Marker strip, flat

0808697

<https://www.phoenixcontact.com/us/products/0808697>



Zack Marker strip, flat, Strip, white, labeled, Printed vertically: consecutive numbers 1 ... 10, 11 ... 20, etc. up to 91 ... 100, mounting type: snapped, for terminal block width: 5 mm, lettering field size: 5.15 x 5.15 mm, Number of individual labels: 10

ZBF 5,LGS:GERADE ZAHLEN - Zack Marker strip, flat

0810821

<https://www.phoenixcontact.com/us/products/0810821>



Zack Marker strip, flat, Strip, white, labeled, printed horizontally: consecutive even numbers 2 ... 20, 22 ... 40, etc. up to 82 ... 100, mounting type: snapped, for terminal block width: 5 mm, lettering field size: 5.15 x 5.15 mm, Number of individual labels: 10

ST 2,5-QUATTRO/2P - Feed-through terminal block



3040038

<https://www.phoenixcontact.com/us/products/3040038>

ZBF 5,LGS:UNGERADE ZAHLEN - Zack Marker strip, flat

0810863

<https://www.phoenixcontact.com/us/products/0810863>



Zack Marker strip, flat, Strip, white, labeled, printed horizontally: Odd numbers 1 - 19, 21 - 39, etc. up to 81 - 99, mounting type: snapped, for terminal block width: 5 mm, lettering field size: 5.15 x 5.15 mm, Number of individual labels: 10

UC-TMF 5 - Marker for terminal blocks

0818153

<https://www.phoenixcontact.com/us/products/0818153>

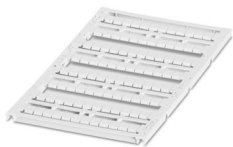

Marker for terminal blocks, Sheet, white, unlabeled, can be labeled with: BLUEMARK ID COLOR, BLUEMARK ID, BLUEMARK CLED, PLOTMARK, CMS-P1-PLOTTER, mounting type: snapped, for terminal block width: 5.2 mm, lettering field size: 4.6 x 5.1 mm, Number of individual labels: 96

ST 2,5-QUATTRO/2P - Feed-through terminal block



3040038

<https://www.phoenixcontact.com/us/products/3040038>

UC-TMF 5 CUS - Marker for terminal blocks

0824638

<https://www.phoenixcontact.com/us/products/0824638>



Marker for terminal blocks, can be ordered: by sheet, white, labeled according to customer specifications, mounting type: snap into flat marker groove, for terminal block width: 5.2 mm, lettering field size: 4.6 x 5.1 mm, Number of individual labels: 96

UCT-TMF 5 - Marker for terminal blocks

0828744

<https://www.phoenixcontact.com/us/products/0828744>



Marker for terminal blocks, Sheet, white, unlabeled, can be labeled with: TOPMARK NEO, TOPMARK LASER, BLUEMARK ID COLOR, BLUEMARK ID, BLUEMARK CLED, THERMOMARK PRIME, THERMOMARK CARD 2.0, THERMOMARK CARD, mounting type: snapped, for terminal block width: 5.2 mm, lettering field size: 4.4 x 4.7 mm, Number of individual labels: 72

ST 2,5-QUATTRO/2P - Feed-through terminal block

3040038

<https://www.phoenixcontact.com/us/products/3040038>



UCT-TMF 5 CUS - Marker for terminal blocks

0829658

<https://www.phoenixcontact.com/us/products/0829658>



Marker for terminal blocks, can be ordered: by sheet, white, labeled according to customer specifications, mounting type: snap into flat marker groove, for terminal block width: 5.2 mm, lettering field size: 4.4 x 4.7 mm, Number of individual labels: 72

MPS-MT - Test plug

0201744

<https://www.phoenixcontact.com/us/products/0201744>



Test plug, with solder connection up to 1 mm² conductor cross section, number of positions: 1, color: gray

ST 2,5-QUATTRO/2P - Feed-through terminal block



3040038

<https://www.phoenixcontact.com/us/products/3040038>

MPS-IH WH - Insulating sleeve

0201663

<https://www.phoenixcontact.com/us/products/0201663>

Insulating sleeve, color: white



MPS-IH RD - Insulating sleeve

0201676

<https://www.phoenixcontact.com/us/products/0201676>

Insulating sleeve, color: red



ST 2,5-QUATTRO/2P - Feed-through terminal block



3040038

<https://www.phoenixcontact.com/us/products/3040038>

MPS-IH BU - Insulating sleeve

0201689

<https://www.phoenixcontact.com/us/products/0201689>

Insulating sleeve, color: blue

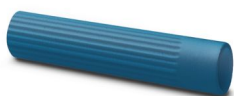

MPS-IH YE - Insulating sleeve

0201692

<https://www.phoenixcontact.com/us/products/0201692>

Insulating sleeve, color: yellow



ST 2,5-QUATTRO/2P - Feed-through terminal block



3040038

<https://www.phoenixcontact.com/us/products/3040038>

MPS-IH GN - Insulating sleeve

0201702

<https://www.phoenixcontact.com/us/products/0201702>

Insulating sleeve, color: green



MPS-IH GY - Insulating sleeve

0201728

<https://www.phoenixcontact.com/us/products/0201728>

Insulating sleeve, color: gray



ST 2,5-QUATTRO/2P - Feed-through terminal block

3040038

<https://www.phoenixcontact.com/us/products/3040038>



MPS-IH BK - Insulating sleeve

0201731

<https://www.phoenixcontact.com/us/products/0201731>

Insulating sleeve, color: black



ISH 2,5/0,2 - Insulating sleeve

3002843

<https://www.phoenixcontact.com/us/products/3002843>

Insulating sleeve, color: white



ST 2,5-QUATTRO/2P - Feed-through terminal block



3040038

<https://www.phoenixcontact.com/us/products/3040038>

ISH 2,5/0,5 - Insulating sleeve

3002856

<https://www.phoenixcontact.com/us/products/3002856>



Insulating sleeve, color: gray

ISH 2,5/1,0 - Insulating sleeve

3002869

<https://www.phoenixcontact.com/us/products/3002869>



Insulating sleeve, color: black

ST 2,5-QUATTRO/2P - Feed-through terminal block



3040038

<https://www.phoenixcontact.com/us/products/3040038>

PAI-4-FIX-5/6 BU - Test adapter

3035975

<https://www.phoenixcontact.com/us/products/3035975>



4 mm test adapter, for terminal blocks with 5.2 mm and 6.2 mm pitch

PAI-4-FIX-5/6 OG - Test adapter

3035974

<https://www.phoenixcontact.com/us/products/3035974>



4 mm test adapter, for terminal blocks with 5.2 mm and 6.2 mm pitch

ST 2,5-QUATTRO/2P - Feed-through terminal block



3040038

<https://www.phoenixcontact.com/us/products/3040038>

PAI-4-FIX-5/6 YE - Test adapter

3035977

<https://www.phoenixcontact.com/us/products/3035977>



4 mm test adapter, for terminal blocks with 5.2 mm and 6.2 mm pitch

PAI-4-FIX-5/6 RD - Test adapter

3035976

<https://www.phoenixcontact.com/us/products/3035976>



4 mm test adapter, for terminal blocks with 5.2 mm and 6.2 mm pitch

ST 2,5-QUATTRO/2P - Feed-through terminal block



3040038

<https://www.phoenixcontact.com/us/products/3040038>

PAI-4-FIX-5/6 GN - Test adapter

3035978

<https://www.phoenixcontact.com/us/products/3035978>



4 mm test adapter, for terminal blocks with 5.2 mm and 6.2 mm pitch

PAI-4-FIX-5/6 BK - Test adapter

3035980

<https://www.phoenixcontact.com/us/products/3035980>



4 mm test adapter, for terminal blocks with 5.2 mm and 6.2 mm pitch

ST 2,5-QUATTRO/2P - Feed-through terminal block



3040038

<https://www.phoenixcontact.com/us/products/3040038>

PAI-4-FIX-5/6 GY - Test adapter

3035982

<https://www.phoenixcontact.com/us/products/3035982>



4 mm test adapter, for terminal blocks with 5.2 mm and 6.2 mm pitch

PAI-4-FIX-5/6 VT - Test adapter

3035979

<https://www.phoenixcontact.com/us/products/3035979>



4 mm test adapter, for terminal blocks with 5.2 mm and 6.2 mm pitch

ST 2,5-QUATTRO/2P - Feed-through terminal block



3040038

<https://www.phoenixcontact.com/us/products/3040038>

PAI-4-FIX-5/6 BN - Test adapter

3035981

<https://www.phoenixcontact.com/us/products/3035981>



4 mm test adapter, for terminal blocks with 5.2 mm and 6.2 mm pitch

PAI-4-FIX-5/6 WH - Test adapter

3035983

<https://www.phoenixcontact.com/us/products/3035983>



4 mm test adapter, for terminal blocks with 5.2 mm and 6.2 mm pitch

ST 2,5-QUATTRO/2P - Feed-through terminal block



3040038

<https://www.phoenixcontact.com/us/products/3040038>

PS-5 - Test plug

3030983

<https://www.phoenixcontact.com/us/products/3030983>



Test plug, Modular test plug, number of positions: 1, color: red

DP PS-5 - Spacer plate

3036725

<https://www.phoenixcontact.com/us/products/3036725>



Spacer plate, depth: 29 mm, width: 5.2 mm, height: 22.4 mm, number of positions: 1, color: red

ST 2,5-QUATTRO/2P - Feed-through terminal block

3040038

<https://www.phoenixcontact.com/us/products/3040038>



PS-5/2,3MM RD - Test plug

3038723

<https://www.phoenixcontact.com/us/products/3038723>

Test plug, number of positions: 1, color: red



E/AL-NS 35 - End bracket

1201662

<https://www.phoenixcontact.com/us/products/1201662>

End clamp, for end support of UKH 50 to UKH 240, is pushed onto DIN rail NS 35 and fixed with 2 screws, width: 10 mm, color: aluminum



ST 2,5-QUATTRO/2P - Feed-through terminal block



3040038

<https://www.phoenixcontact.com/us/products/3040038>

SP 2,5/ 1 - Plug

3040258

<https://www.phoenixcontact.com/us/products/3040258>



Plug, nom. voltage: 500 V, nominal current: 24 A, number of positions: 1, connection method: Spring-cage connection, Rated cross section: 2.5 mm², cross section: 0.08 mm²- 4 mm², color: gray

SP 2,5/ 2 - Plug

3040261

<https://www.phoenixcontact.com/us/products/3040261>



Plug, nom. voltage: 500 V, nominal current: 24 A, number of positions: 2, connection method: Spring-cage connection, Rated cross section: 2.5 mm², cross section: 0.08 mm²- 4 mm², color: gray

ST 2,5-QUATTRO/2P - Feed-through terminal block



3040038

<https://www.phoenixcontact.com/us/products/3040038>

SP 2,5/ 3 - Plug

3040274

<https://www.phoenixcontact.com/us/products/3040274>



Plug, nom. voltage: 500 V, nominal current: 24 A, number of positions: 3, connection method: Spring-cage connection, Rated cross section: 2.5 mm², cross section: 0.08 mm²- 4 mm², color: gray

SP 2,5/ 4 - Plug

3040287

<https://www.phoenixcontact.com/us/products/3040287>



Plug, nom. voltage: 500 V, nominal current: 24 A, number of positions: 4, connection method: Spring-cage connection, Rated cross section: 2.5 mm², cross section: 0.08 mm²- 4 mm², color: gray

ST 2,5-QUATTRO/2P - Feed-through terminal block

3040038

<https://www.phoenixcontact.com/us/products/3040038>

SP 2,5/ 5 - Plug

3040290

<https://www.phoenixcontact.com/us/products/3040290>



Plug, nom. voltage: 500 V, nominal current: 24 A, number of positions: 5, connection method: Spring-cage connection, Rated cross section: 2.5 mm², cross section: 0.08 mm²- 4 mm², color: gray

SP 2,5/ 6 - Plug

3040300

<https://www.phoenixcontact.com/us/products/3040300>



Plug, nom. voltage: 500 V, nominal current: 24 A, number of positions: 6, connection method: Spring-cage connection, Rated cross section: 2.5 mm², cross section: 0.08 mm²- 4 mm², color: gray

ST 2,5-QUATTRO/2P - Feed-through terminal block



3040038

<https://www.phoenixcontact.com/us/products/3040038>

SP 2,5/ 7 - Plug

3040313

<https://www.phoenixcontact.com/us/products/3040313>



Plug, nom. voltage: 500 V, nominal current: 24 A, number of positions: 7, connection method: Spring-cage connection, Rated cross section: 2.5 mm², cross section: 0.08 mm²- 4 mm², color: gray

SP 2,5/ 8 - Plug

3040326

<https://www.phoenixcontact.com/us/products/3040326>



Plug, nom. voltage: 500 V, nominal current: 24 A, number of positions: 8, connection method: Spring-cage connection, Rated cross section: 2.5 mm², cross section: 0.08 mm²- 4 mm², color: gray

ST 2,5-QUATTRO/2P - Feed-through terminal block



3040038

<https://www.phoenixcontact.com/us/products/3040038>

SP 2,5/ 9 - Plug

3040339

<https://www.phoenixcontact.com/us/products/3040339>



Plug, nom. voltage: 500 V, nominal current: 24 A, number of positions: 9, connection method: Spring-cage connection, Rated cross section: 2.5 mm², cross section: 0.08 mm²- 4 mm², color: gray

SP 2,5/10 - Plug

3040342

<https://www.phoenixcontact.com/us/products/3040342>



Plug, nom. voltage: 500 V, nominal current: 24 A, number of positions: 10, connection method: Spring-cage connection, Rated cross section: 2.5 mm², cross section: 0.08 mm²- 4 mm², color: gray

ST 2,5-QUATTRO/2P - Feed-through terminal block



3040038

<https://www.phoenixcontact.com/us/products/3040038>

SP 2,5/11 - Plug

3040355

<https://www.phoenixcontact.com/us/products/3040355>



Plug, nom. voltage: 500 V, nominal current: 24 A, number of positions: 11, connection method: Spring-cage connection, Rated cross section: 2.5 mm², cross section: 0.08 mm²- 4 mm², color: gray

SP 2,5/12 - Plug

3040368

<https://www.phoenixcontact.com/us/products/3040368>



Plug, nom. voltage: 500 V, nominal current: 24 A, number of positions: 12, connection method: Spring-cage connection, Rated cross section: 2.5 mm², cross section: 0.08 mm²- 4 mm², color: gray

ST 2,5-QUATTRO/2P - Feed-through terminal block



3040038

<https://www.phoenixcontact.com/us/products/3040038>

SP 2,5/13 - Plug

3040371

<https://www.phoenixcontact.com/us/products/3040371>



Plug, nom. voltage: 500 V, nominal current: 24 A, number of positions: 13, connection method: Spring-cage connection, Rated cross section: 2.5 mm², cross section: 0.08 mm²- 4 mm², color: gray

SP 2,5/14 - Plug

3040384

<https://www.phoenixcontact.com/us/products/3040384>



Plug, nom. voltage: 500 V, nominal current: 24 A, number of positions: 14, connection method: Spring-cage connection, Rated cross section: 2.5 mm², cross section: 0.08 mm²- 4 mm², color: gray

ST 2,5-QUATTRO/2P - Feed-through terminal block



3040038

<https://www.phoenixcontact.com/us/products/3040038>

SP 2,5/15 - Plug

3040397

<https://www.phoenixcontact.com/us/products/3040397>



Plug, nom. voltage: 500 V, nominal current: 24 A, number of positions: 15, connection method: Spring-cage connection, Rated cross section: 2.5 mm², cross section: 0.08 mm²- 4 mm², color: gray

SP 2,5/ 1 BU - Plug

3040698

<https://www.phoenixcontact.com/us/products/3040698>



Plug, nom. voltage: 500 V, nominal current: 24 A, number of positions: 1, connection method: Spring-cage connection, Rated cross section: 2.5 mm², cross section: 0.08 mm²- 4 mm², color: blue

ST 2,5-QUATTRO/2P - Feed-through terminal block

3040038

<https://www.phoenixcontact.com/us/products/3040038>

SP 2,5/ 1 GNYE - Plug

3040708

<https://www.phoenixcontact.com/us/products/3040708>



Plug, nom. voltage: 500 V, nominal current: 24 A, number of positions: 1, connection method: Spring-cage connection, Rated cross section: 2.5 mm², cross section: 0.08 mm²- 4 mm², color: green-yellow

SPB 2,5/ 1 - Plug

3040106

<https://www.phoenixcontact.com/us/products/3040106>



Plug, nom. voltage: 500 V, nominal current: 24 A, number of positions: 1, connection method: Spring-cage connection, Rated cross section: 2.5 mm², cross section: 0.08 mm²- 4 mm², color: gray

ST 2,5-QUATTRO/2P - Feed-through terminal block

3040038

<https://www.phoenixcontact.com/us/products/3040038>

SPB 2,5/ 9 - Plug

3040180

<https://www.phoenixcontact.com/us/products/3040180>



Plug, nom. voltage: 500 V, nominal current: 24 A, number of positions: 9, connection method: Spring-cage connection, Rated cross section: 2.5 mm², cross section: 0.08 mm²- 4 mm², color: gray

SPB 2,5/11 - Plug

3040203

<https://www.phoenixcontact.com/us/products/3040203>



Plug, nom. voltage: 500 V, nominal current: 24 A, number of positions: 11, connection method: Spring-cage connection, Rated cross section: 2.5 mm², cross section: 0.08 mm²- 4 mm², color: gray

ST 2,5-QUATTRO/2P - Feed-through terminal block

3040038

<https://www.phoenixcontact.com/us/products/3040038>

SPB 2,5/13 - Plug

3040229

<https://www.phoenixcontact.com/us/products/3040229>



Plug, nom. voltage: 500 V, nominal current: 24 A, number of positions: 13, connection method: Spring-cage connection, Rated cross section: 2.5 mm², cross section: 0.08 mm²- 4 mm², color: gray

SPB 2,5/14 - Plug

3040232

<https://www.phoenixcontact.com/us/products/3040232>



Plug, nom. voltage: 500 V, nominal current: 24 A, number of positions: 14, connection method: Spring-cage connection, Rated cross section: 2.5 mm², cross section: 0.08 mm²- 4 mm², color: gray

ST 2,5-QUATTRO/2P - Feed-through terminal block

3040038

<https://www.phoenixcontact.com/us/products/3040038>

SPB 2,5/ 1 BU - Plug

3040724

<https://www.phoenixcontact.com/us/products/3040724>



Plug, nom. voltage: 500 V, nominal current: 24 A, number of positions: 1, connection method: Spring-cage connection, Rated cross section: 2.5 mm², cross section: 0.08 mm²- 4 mm², color: blue

SPB 2,5/ 1 GNYE - Plug

3040711

<https://www.phoenixcontact.com/us/products/3040711>



Plug, nom. voltage: 500 V, nominal current: 24 A, number of positions: 1, connection method: Spring-cage connection, Rated cross section: 2.5 mm², cross section: 0.08 mm²- 4 mm², color: green-yellow

ST 2,5-QUATTRO/2P - Feed-through terminal block



3040038

<https://www.phoenixcontact.com/us/products/3040038>

SPDB 2,5/ 1 - Plug

3040407

<https://www.phoenixcontact.com/us/products/3040407>



Plug, nom. voltage: 500 V, nominal current: 24 A, number of positions: 1, connection method: Spring-cage connection, Rated cross section: 2.5 mm², cross section: 0.08 mm²- 4 mm², color: gray

SPDB 2,5/ 9 - Plug

3040481

<https://www.phoenixcontact.com/us/products/3040481>



Plug, nom. voltage: 500 V, nominal current: 24 A, number of positions: 9, connection method: Spring-cage connection, Rated cross section: 2.5 mm², cross section: 0.08 mm²- 4 mm², color: gray

ST 2,5-QUATTRO/2P - Feed-through terminal block



3040038

<https://www.phoenixcontact.com/us/products/3040038>

SPDB 2,5/12 - Plug

3040517

<https://www.phoenixcontact.com/us/products/3040517>



Plug, nom. voltage: 500 V, nominal current: 24 A, number of positions: 12, connection method: Spring-cage connection, Rated cross section: 2.5 mm², cross section: 0.08 mm²- 4 mm², color: gray

SPDB 2,5/13 - Plug

3040520

<https://www.phoenixcontact.com/us/products/3040520>



Plug, nom. voltage: 500 V, nominal current: 24 A, number of positions: 13, connection method: Spring-cage connection, Rated cross section: 2.5 mm², cross section: 0.08 mm²- 4 mm², color: gray

ST 2,5-QUATTRO/2P - Feed-through terminal block



3040038

<https://www.phoenixcontact.com/us/products/3040038>

SPDB 2,5/14 - Plug

3040533

<https://www.phoenixcontact.com/us/products/3040533>



Plug, nom. voltage: 500 V, nominal current: 24 A, number of positions: 14, connection method: Spring-cage connection, Rated cross section: 2.5 mm², cross section: 0.08 mm²- 4 mm², color: gray

SPDB 2,5/ 1 BU - Plug

3040737

<https://www.phoenixcontact.com/us/products/3040737>



Plug, nom. voltage: 500 V, nominal current: 24 A, number of positions: 1, connection method: Spring-cage connection, Rated cross section: 2.5 mm², cross section: 0.08 mm²- 4 mm², color: blue

ST 2,5-QUATTRO/2P - Feed-through terminal block



3040038

<https://www.phoenixcontact.com/us/products/3040038>

SPDB 2,5/ 1 GNYE - Plug

3040740

<https://www.phoenixcontact.com/us/products/3040740>



Plug, nom. voltage: 500 V, nominal current: 24 A, number of positions: 1, connection method: Spring-cage connection, Rated cross section: 2.5 mm², cross section: 0.08 mm²- 4 mm², color: green-yellow

SP-H 2,5/ 1 - Plug

3210619

<https://www.phoenixcontact.com/us/products/3210619>



Plug, nom. voltage: 500 V, nominal current: 24 A, number of positions: 1, connection method: Spring-cage connection, Rated cross section: 2.5 mm², cross section: 0.08 mm²- 4 mm², color: gray

ST 2,5-QUATTRO/2P - Feed-through terminal block



3040038

<https://www.phoenixcontact.com/us/products/3040038>

SP-H 2,5/ 2 - Plug

3210622

<https://www.phoenixcontact.com/us/products/3210622>



Plug, nom. voltage: 500 V, nominal current: 24 A, number of positions: 2, connection method: Spring-cage connection, Rated cross section: 2.5 mm², cross section: 0.08 mm²- 4 mm², color: gray

SP-H 2,5/ 3 - Plug

3210635

<https://www.phoenixcontact.com/us/products/3210635>



Plug, nom. voltage: 500 V, nominal current: 24 A, number of positions: 3, connection method: Spring-cage connection, Rated cross section: 2.5 mm², cross section: 0.08 mm²- 4 mm², color: gray

ST 2,5-QUATTRO/2P - Feed-through terminal block

3040038

<https://www.phoenixcontact.com/us/products/3040038>

SP-H 2,5/ 4 - Plug

3210648

<https://www.phoenixcontact.com/us/products/3210648>



Plug, nom. voltage: 500 V, nominal current: 24 A, number of positions: 4, connection method: Spring-cage connection, Rated cross section: 2.5 mm², cross section: 0.08 mm²- 4 mm², color: gray

SP-H 2,5/ 5 - Plug

3210651

<https://www.phoenixcontact.com/us/products/3210651>



Plug, nom. voltage: 500 V, nominal current: 24 A, number of positions: 5, connection method: Spring-cage connection, Rated cross section: 2.5 mm², cross section: 0.08 mm²- 4 mm², color: gray

ST 2,5-QUATTRO/2P - Feed-through terminal block



3040038

<https://www.phoenixcontact.com/us/products/3040038>

SP-H 2,5/ 6 - Plug

3210664

<https://www.phoenixcontact.com/us/products/3210664>



Plug, nom. voltage: 500 V, nominal current: 24 A, number of positions: 6, connection method: Spring-cage connection, Rated cross section: 2.5 mm², cross section: 0.08 mm²- 4 mm², color: gray

SP-H 2,5/ 7 - Plug

3210677

<https://www.phoenixcontact.com/us/products/3210677>



Plug, nom. voltage: 500 V, nominal current: 24 A, number of positions: 7, connection method: Spring-cage connection, Rated cross section: 2.5 mm², cross section: 0.08 mm²- 4 mm², color: gray

ST 2,5-QUATTRO/2P - Feed-through terminal block

3040038

<https://www.phoenixcontact.com/us/products/3040038>

SP-H 2,5/ 8 - Plug

3210680

<https://www.phoenixcontact.com/us/products/3210680>



Plug, nom. voltage: 500 V, nominal current: 24 A, number of positions: 8, connection method: Spring-cage connection, Rated cross section: 2.5 mm², cross section: 0.08 mm²- 4 mm², color: gray

SP-H 2,5/ 9 - Plug

3210693

<https://www.phoenixcontact.com/us/products/3210693>



Plug, nom. voltage: 500 V, nominal current: 24 A, number of positions: 9, connection method: Spring-cage connection, Rated cross section: 2.5 mm², cross section: 0.08 mm²- 4 mm², color: gray

ST 2,5-QUATTRO/2P - Feed-through terminal block



3040038

<https://www.phoenixcontact.com/us/products/3040038>

SP-H 2,5/10 - Plug

3210703

<https://www.phoenixcontact.com/us/products/3210703>



Plug, nom. voltage: 500 V, nominal current: 24 A, number of positions: 10, connection method: Spring-cage connection, Rated cross section: 2.5 mm², cross section: 0.08 mm²- 4 mm², color: gray

SP-H 2,5/11 - Plug

3210716

<https://www.phoenixcontact.com/us/products/3210716>



Plug, nom. voltage: 500 V, nominal current: 24 A, number of positions: 11, connection method: Spring-cage connection, Rated cross section: 2.5 mm², cross section: 0.08 mm²- 4 mm², color: gray

ST 2,5-QUATTRO/2P - Feed-through terminal block



3040038

<https://www.phoenixcontact.com/us/products/3040038>

SP-H 2,5/12 - Plug

3210729

<https://www.phoenixcontact.com/us/products/3210729>



Plug, nom. voltage: 500 V, nominal current: 24 A, number of positions: 12, connection method: Spring-cage connection, Rated cross section: 2.5 mm², cross section: 0.08 mm²- 4 mm², color: gray

SP-H 2,5/13 - Plug

3210732

<https://www.phoenixcontact.com/us/products/3210732>



Plug, nom. voltage: 500 V, nominal current: 24 A, number of positions: 13, connection method: Spring-cage connection, Rated cross section: 2.5 mm², cross section: 0.08 mm²- 4 mm², color: gray

ST 2,5-QUATTRO/2P - Feed-through terminal block



3040038

<https://www.phoenixcontact.com/us/products/3040038>

SP-H 2,5/15 - Plug

3210758

<https://www.phoenixcontact.com/us/products/3210758>



Plug, nom. voltage: 500 V, nominal current: 24 A, number of positions: 15, connection method: Spring-cage connection, Rated cross section: 2.5 mm², cross section: 0.08 mm²- 4 mm², color: gray

SP-H 2,5/ 1 BU - Plug

3210761

<https://www.phoenixcontact.com/us/products/3210761>



Plug, nom. voltage: 500 V, nominal current: 24 A, number of positions: 1, connection method: Spring-cage connection, Rated cross section: 2.5 mm², cross section: 0.08 mm²- 4 mm², color: blue

ST 2,5-QUATTRO/2P - Feed-through terminal block



3040038

<https://www.phoenixcontact.com/us/products/3040038>

SP-H 2,5/ 1 GNYE - Plug

3210774

<https://www.phoenixcontact.com/us/products/3210774>



Plug, nom. voltage: 500 V, nominal current: 24 A, number of positions: 1, connection method: Spring-cage connection, Rated cross section: 2.5 mm², cross section: 0.08 mm²- 4 mm², color: green-yellow

SP-H 2,5/ 1-L - Plug

3210787

<https://www.phoenixcontact.com/us/products/3210787>



Plug, nom. voltage: 500 V, nominal current: 24 A, number of positions: 1, connection method: Spring-cage connection, Rated cross section: 2.5 mm², cross section: 0.08 mm²- 4 mm², color: gray

ST 2,5-QUATTRO/2P - Feed-through terminal block



3040038

<https://www.phoenixcontact.com/us/products/3040038>

SP-H 2,5/ 1-L BU - Plug

3210790

<https://www.phoenixcontact.com/us/products/3210790>



Plug, nom. voltage: 500 V, nominal current: 24 A, number of positions: 1, connection method: Spring-cage connection, Rated cross section: 2.5 mm², cross section: 0.08 mm²- 4 mm², color: blue

SP-H 2,5/ 1-L GNYE - Plug

3210800

<https://www.phoenixcontact.com/us/products/3210800>



Plug, nom. voltage: 500 V, nominal current: 24 A, number of positions: 1, connection method: Spring-cage connection, Rated cross section: 2.5 mm², cross section: 0.08 mm²- 4 mm², color: green-yellow

ST 2,5-QUATTRO/2P - Feed-through terminal block



3040038

<https://www.phoenixcontact.com/us/products/3040038>

SP-H 2,5/ 1-M - Plug

3210813

<https://www.phoenixcontact.com/us/products/3210813>



Plug, nom. voltage: 500 V, nominal current: 24 A, number of positions: 1, connection method: Spring-cage connection, Rated cross section: 2.5 mm², cross section: 0.08 mm²- 4 mm², color: gray

SP-H 2,5/ 1-M BU - Plug

3210826

<https://www.phoenixcontact.com/us/products/3210826>



Plug, nom. voltage: 500 V, nominal current: 24 A, number of positions: 1, connection method: Spring-cage connection, Rated cross section: 2.5 mm², cross section: 0.08 mm²- 4 mm², color: blue

ST 2,5-QUATTRO/2P - Feed-through terminal block



3040038

<https://www.phoenixcontact.com/us/products/3040038>

SP-H 2,5/ 1-M GNYE - Plug

3210839

<https://www.phoenixcontact.com/us/products/3210839>



Plug, nom. voltage: 500 V, nominal current: 24 A, number of positions: 1, connection method: Spring-cage connection, Rated cross section: 2.5 mm², cross section: 0.08 mm²- 4 mm², color: green-yellow

SP-H 2,5/ 1-R - Plug

3210842

<https://www.phoenixcontact.com/us/products/3210842>



Plug, nom. voltage: 500 V, nominal current: 24 A, number of positions: 1, connection method: Spring-cage connection, Rated cross section: 2.5 mm², cross section: 0.08 mm²- 4 mm², color: gray

ST 2,5-QUATTRO/2P - Feed-through terminal block



3040038

<https://www.phoenixcontact.com/us/products/3040038>

SP-H 2,5/ 1-R BU - Plug

3210855

<https://www.phoenixcontact.com/us/products/3210855>



Plug, nom. voltage: 500 V, nominal current: 24 A, number of positions: 1, connection method: Spring-cage connection, Rated cross section: 2.5 mm², cross section: 0.08 mm²- 4 mm², color: blue

SP-H 2,5/ 1-R GNYE - Plug

3210868

<https://www.phoenixcontact.com/us/products/3210868>



Plug, nom. voltage: 500 V, nominal current: 24 A, number of positions: 1, connection method: Spring-cage connection, Rated cross section: 2.5 mm², cross section: 0.08 mm²- 4 mm², color: green-yellow

ST 2,5-QUATTRO/2P - Feed-through terminal block

3040038

<https://www.phoenixcontact.com/us/products/3040038>

SPV 2,5/ 1 - Plug

3041710

<https://www.phoenixcontact.com/us/products/3041710>



Plug, nom. voltage: 500 V, nominal current: 24 A, number of positions: 1, connection method: Spring-cage connection, Rated cross section: 2.5 mm², cross section: 0.08 mm²- 4 mm², color: gray

SPV 2,5/ 6 - Plug

3041765

<https://www.phoenixcontact.com/us/products/3041765>



Plug, nom. voltage: 500 V, nominal current: 24 A, number of positions: 6, connection method: Spring-cage connection, Rated cross section: 2.5 mm², cross section: 0.08 mm²- 4 mm², color: gray

ST 2,5-QUATTRO/2P - Feed-through terminal block

3040038

<https://www.phoenixcontact.com/us/products/3040038>

SPV 2,5/ 9 - Plug

3041794

<https://www.phoenixcontact.com/us/products/3041794>



Plug, nom. voltage: 500 V, nominal current: 24 A, number of positions: 9, connection method: Spring-cage connection, Rated cross section: 2.5 mm², cross section: 0.08 mm²- 4 mm², color: gray

SPV 2,5/11 - Plug

3041817

<https://www.phoenixcontact.com/us/products/3041817>



Plug, nom. voltage: 500 V, nominal current: 24 A, number of positions: 11, connection method: Spring-cage connection, Rated cross section: 2.5 mm², cross section: 0.08 mm²- 4 mm², color: gray

ST 2,5-QUATTRO/2P - Feed-through terminal block

3040038

<https://www.phoenixcontact.com/us/products/3040038>

SPV 2,5/12 - Plug

3041820

<https://www.phoenixcontact.com/us/products/3041820>



Plug, nom. voltage: 500 V, nominal current: 24 A, number of positions: 12, connection method: Spring-cage connection, Rated cross section: 2.5 mm², cross section: 0.08 mm²- 4 mm², color: gray

SPV 2,5/13 - Plug

3041833

<https://www.phoenixcontact.com/us/products/3041833>



Plug, nom. voltage: 500 V, nominal current: 24 A, number of positions: 13, connection method: Spring-cage connection, Rated cross section: 2.5 mm², cross section: 0.08 mm²- 4 mm², color: gray

ST 2,5-QUATTRO/2P - Feed-through terminal block



3040038

<https://www.phoenixcontact.com/us/products/3040038>

SPV 2,5/14 - Plug

3041846

<https://www.phoenixcontact.com/us/products/3041846>



Plug, nom. voltage: 500 V, nominal current: 24 A, number of positions: 14, connection method: Spring-cage connection, Rated cross section: 2.5 mm², cross section: 0.08 mm²- 4 mm², color: gray

SPV 2,5/15 - Plug

3041859

<https://www.phoenixcontact.com/us/products/3041859>



Plug, nom. voltage: 500 V, nominal current: 24 A, number of positions: 15, connection method: Spring-cage connection, Rated cross section: 2.5 mm², cross section: 0.08 mm²- 4 mm², color: gray

ST 2,5-QUATTRO/2P - Feed-through terminal block

3040038

<https://www.phoenixcontact.com/us/products/3040038>

SPV 2,5/ 1 BU - Plug

3061017

<https://www.phoenixcontact.com/us/products/3061017>



Plug, nom. voltage: 500 V, nominal current: 24 A, number of positions: 1, connection method: Spring-cage connection, Rated cross section: 2.5 mm², cross section: 0.08 mm²- 4 mm², color: blue

SPV 2,5/ 1 GNYE - Plug

3061020

<https://www.phoenixcontact.com/us/products/3061020>



Plug, nom. voltage: 500 V, nominal current: 24 A, number of positions: 1, connection method: Spring-cage connection, Rated cross section: 2.5 mm², cross section: 0.08 mm²- 4 mm², color: green-yellow

ST 2,5-QUATTRO/2P - Feed-through terminal block

3040038

<https://www.phoenixcontact.com/us/products/3040038>

SPV 2,5/ 1-L - Plug

3041024

<https://www.phoenixcontact.com/us/products/3041024>



Plug, nom. voltage: 500 V, nominal current: 24 A, number of positions: 1, connection method: Spring-cage connection, Rated cross section: 2.5 mm², cross section: 0.08 mm²- 4 mm², color: gray

SPV 2,5/ 1-L BU - Plug

3041037

<https://www.phoenixcontact.com/us/products/3041037>



Plug, nom. voltage: 500 V, nominal current: 24 A, number of positions: 1, connection method: Spring-cage connection, Rated cross section: 2.5 mm², cross section: 0.08 mm²- 4 mm², color: blue

ST 2,5-QUATTRO/2P - Feed-through terminal block



3040038

<https://www.phoenixcontact.com/us/products/3040038>

SPV 2,5/ 1-L GNYE - Plug

3041040

<https://www.phoenixcontact.com/us/products/3041040>



Plug, nom. voltage: 500 V, nominal current: 24 A, number of positions: 1, connection method: Spring-cage connection, Rated cross section: 2.5 mm², cross section: 0.08 mm²- 4 mm², color: green-yellow

SPV 2,5/ 1-M - Plug

3041053

<https://www.phoenixcontact.com/us/products/3041053>



Plug, nom. voltage: 500 V, nominal current: 24 A, number of positions: 1, connection method: Spring-cage connection, Rated cross section: 2.5 mm², cross section: 0.08 mm²- 4 mm², color: gray

ST 2,5-QUATTRO/2P - Feed-through terminal block

3040038

<https://www.phoenixcontact.com/us/products/3040038>

SPV 2,5/ 1-M BU - Plug

3041066

<https://www.phoenixcontact.com/us/products/3041066>



Plug, nom. voltage: 500 V, nominal current: 24 A, number of positions: 1, connection method: Spring-cage connection, Rated cross section: 2.5 mm², cross section: 0.08 mm²- 4 mm², color: blue

SPV 2,5/ 1-M GNYE - Plug

3041079

<https://www.phoenixcontact.com/us/products/3041079>



Plug, nom. voltage: 500 V, nominal current: 24 A, number of positions: 1, connection method: Spring-cage connection, Rated cross section: 2.5 mm², cross section: 0.08 mm²- 4 mm², color: green-yellow

ST 2,5-QUATTRO/2P - Feed-through terminal block

3040038

<https://www.phoenixcontact.com/us/products/3040038>

SPV 2,5/ 1-R - Plug

3041082

<https://www.phoenixcontact.com/us/products/3041082>



Plug, nom. voltage: 500 V, nominal current: 24 A, number of positions: 1, connection method: Spring-cage connection, Rated cross section: 2.5 mm², cross section: 0.08 mm²- 4 mm², color: gray

SPV 2,5/ 1-R BU - Plug

3041095

<https://www.phoenixcontact.com/us/products/3041095>



Plug, nom. voltage: 500 V, nominal current: 24 A, number of positions: 1, connection method: Spring-cage connection, Rated cross section: 2.5 mm², cross section: 0.08 mm²- 4 mm², color: blue

ST 2,5-QUATTRO/2P - Feed-through terminal block



3040038

<https://www.phoenixcontact.com/us/products/3040038>

SPV 2,5/ 1-R GNYE - Plug

3041105

<https://www.phoenixcontact.com/us/products/3041105>



Plug, nom. voltage: 500 V, nominal current: 24 A, number of positions: 1, connection method: Spring-cage connection, Rated cross section: 2.5 mm², cross section: 0.08 mm²- 4 mm², color: green-yellow

SZF 1-0,6X3,5 - Screwdriver

1204517

<https://www.phoenixcontact.com/us/products/1204517>



Actuation tool, for ST terminal blocks, also suitable for use as a bladed screwdriver, size: 0.6 x 3.5 x 100 mm, 2-component grip, with non-slip grip

ST 2,5-QUATTRO/2P - Feed-through terminal block

3040038

<https://www.phoenixcontact.com/us/products/3040038>



ST-BW - Actuation tool

1207608

<https://www.phoenixcontact.com/us/products/1207608>

Actuation tool, for all 2.5 mm² - 4.0 mm² spring-cages



Phoenix Contact 2024 © - all rights reserved

<https://www.phoenixcontact.com>

Phoenix Contact USA
586 Fulling Mill Road
Middletown, PA 17057, United States
(+717) 944-1300
info@phoenixcon.com