

165172 ✓ ACTIVE



PIDG

TE Internal #: 165172

Crimp Wire Pins, Tabs & Ferrules, Wire Pin, Mating Pin Diameter 1.78 mm [.07 in], 16 - 14 AWG Wire Size, 1 - 2.8 mm² Wire Size, PIDG

[View on TE.com >](#)

Terminals & Splices > Crimp Wire Pins, Tabs & Ferrules > PIDG Formed Wire Pins

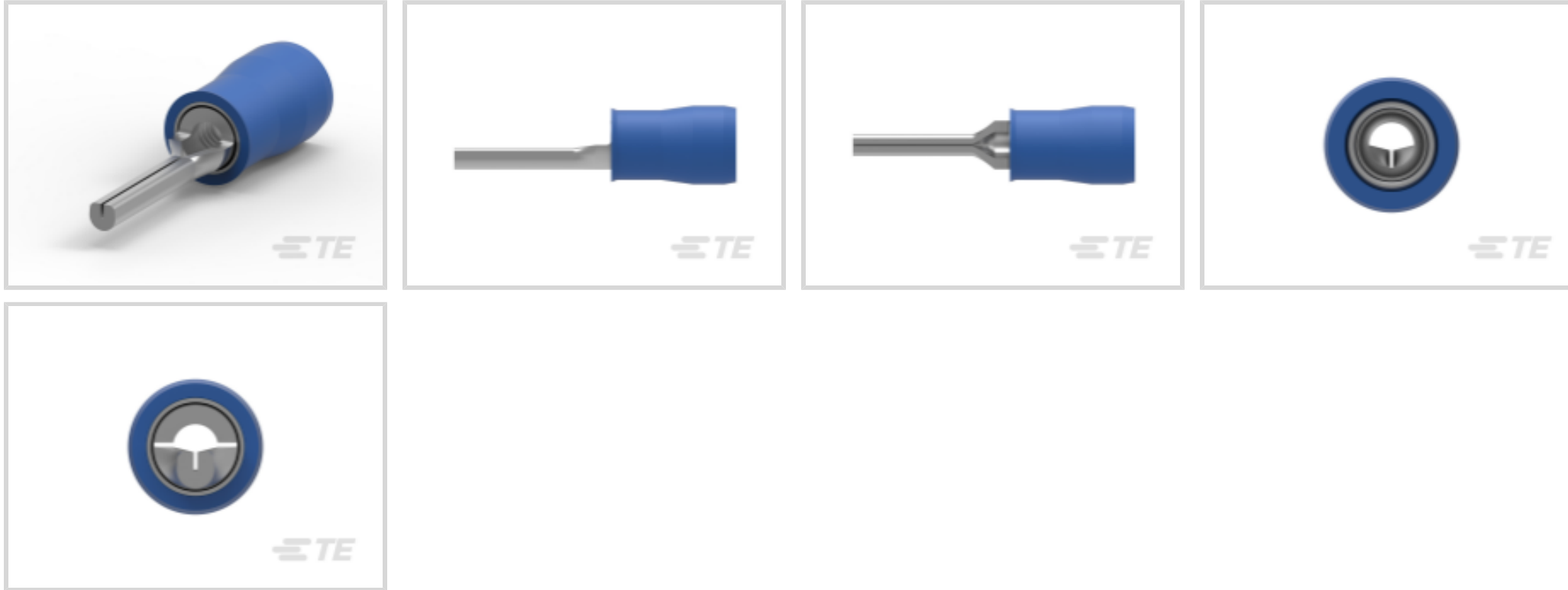

Crimp Wire Terminal Type: **Wire Pin**

Mating Pin Diameter: **1.78 mm [.07 in]**

Compatible Insulation Diameter Range: **4.3 mm [.169 in]**

Wire Size: **1 - 2.8 mm²**

[All PIDG Formed Wire Pins \(6\)](#)

Features

Product Type Features

Sealable	No
Compatible With Discrete Wire Type	Stranded
Wire Insulation Support Retention Type	Insulation Support

Configuration Features

Compatible With Wire & Cable Type	Discrete Wire
-----------------------------------	---------------

Body Features

Sleeve Material	Copper
Insulation Material	Nylon
Primary Product Color	Blue

Contact Features

Contact Mating Area Length	9.9 mm[.39 in]
Contact Fabrication	Stamped & Formed
Crimp Wire Terminal Type	Wire Pin
Mating Pin Diameter	1.78 mm[.07 in]



Barrel Type	Closed
Terminal Plating Material	Tin
Contact Shape & Form	Round
Terminal Orientation	Straight

Mechanical Attachment

Wire Insulation Support	With
-------------------------	------

Dimensions

DIN Wire Size	1 - 2.5 mm ²
Compatible Insulation Diameter Range	4.3 mm[.169 in]
Wire Size	2050 - 5180 CMA
Barrel Inside Diameter	4.4 mm[.173 in]
Terminal Material Thickness	.79 mm[.031 in]
Overall Product Length	23.6 mm[.93 in]

Usage Conditions

Insulation Option	Partially Insulated
Operating Temperature Range	105 °C[221 °F]

Packaging Features

Packaging Quantity	1000
Packaging Method	Loose Piece

Product Compliance

[For compliance documentation, visit the product page on TE.com>](#)

EU RoHS Directive 2011/65/EU	Compliant
EU ELV Directive 2000/53/EC	Compliant
China RoHS 2 Directive MIIT Order No 32, 2016	No Restricted Materials Above Threshold
EU REACH Regulation (EC) No. 1907/2006	Current ECHA Candidate List: JAN 2024 (240) Candidate List Declared Against: JAN 2024 (240) Does not contain REACH SVHC
Halogen Content	Low Halogen - Br, Cl, F, I < 900 ppm per homogenous material. Also BFR/CFR/PVC Free
Solder Process Capability	Not applicable for solder process capability

Product Compliance Disclaimer

This information is provided based on reasonable inquiry of our suppliers and represents our current actual knowledge based on the information they provided. This information is subject to change. The part numbers that TE has identified as EU RoHS compliant have a maximum concentration of 0.1% by weight in homogenous materials for lead, hexavalent chromium, mercury, PBB, PBDE, DBP, BBP, DEHP, DIBP, and 0.01% for cadmium, or qualify for an exemption to these limits as defined in the Annexes of Directive 2011/65/EU (RoHS2). Finished electrical and electronic equipment products will be CE marked as required by Directive 2011/65/EU. Components may not be CE marked. Additionally, the part numbers that TE has identified as EU ELV compliant have a maximum concentration of 0.1% by weight in homogenous materials for lead, hexavalent chromium, and mercury, and 0.01% for cadmium, or qualify for an exemption to these limits as defined in the Annexes of Directive 2000/53/EC (ELV). Regarding the REACH Regulation, the information TE provides on SVHC in articles for this part number is based on the latest European Chemicals Agency (ECHA) 'Guidance on requirements for substances in articles' posted at this URL: <https://echa.europa.eu/guidance-documents/guidance-on-reach>

Compatible Parts



TE Part # 58433-3
PRO CR ASSY, RBY IS9252



TE Part # 47387
DAHT PG PIDG 20-14 ASSY



TE Part # 58423-1
DIE, RBY IS9252



TE Part # 47387-7
DAHT PG PIDG 16-12 ASSY



TE Part # 696274-2
TERM, WIRE PIN, PIDG, 16-14, T&R



TE Part # 525691
DAHT PG PIDG 16-14 ASSY



TE Part # 539691-2
ERGO DIE R.B.Y



TE Part # 1-1377174-4
SMP 0-0165172-0



TE Part # 2063030-1
SDE DIESET, RBY, UL



TE Part # 169400
CERTI-LOK FRAME W/O DIES

TE Part # 2392022-2
BLUE BATTERY DAHT KIT 220V (47387-7)

TE Part # 2392022-1
BLUE BATTERY DAHT KIT 110V (47387-7)



Also in the Series | PIDG

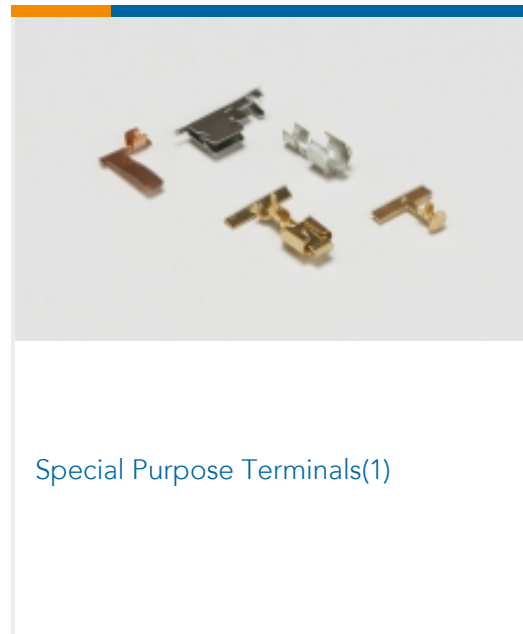
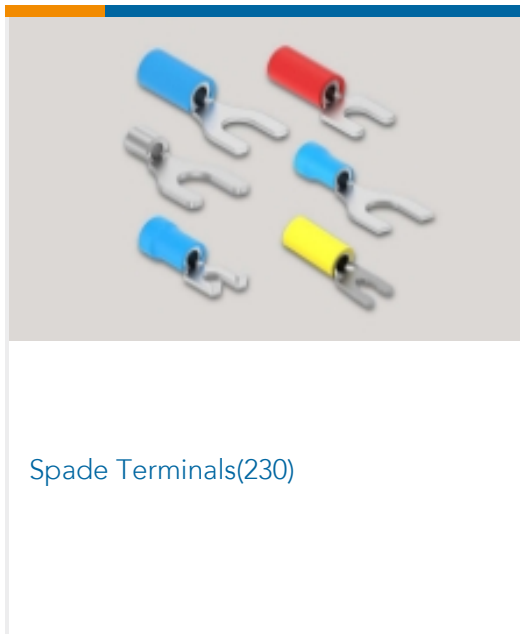
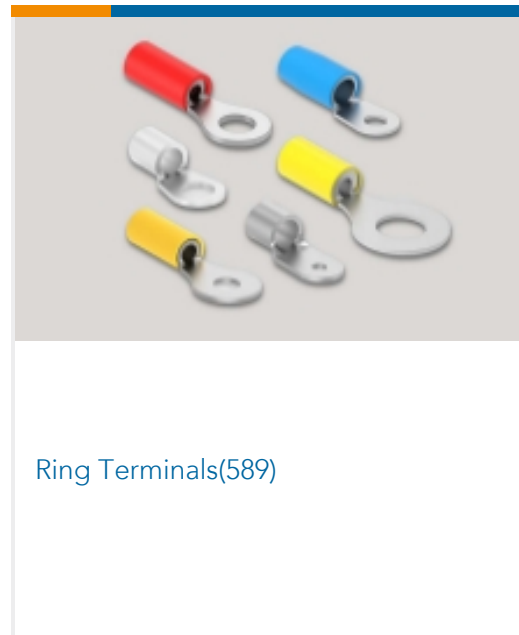
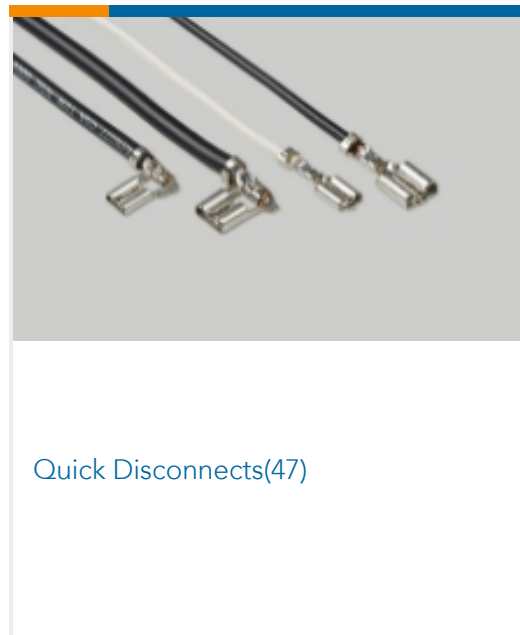
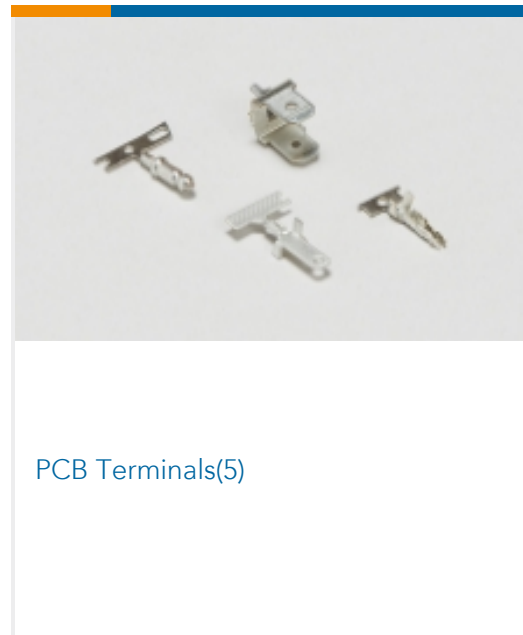
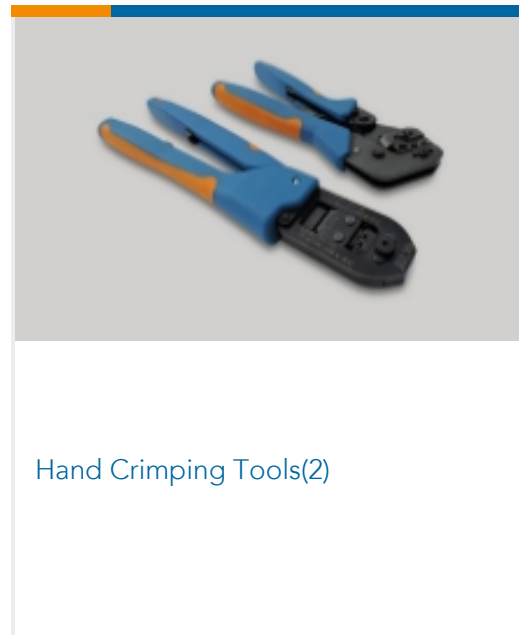
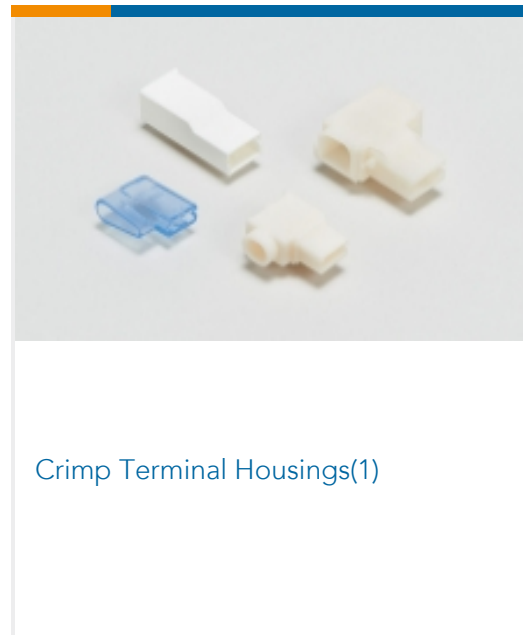
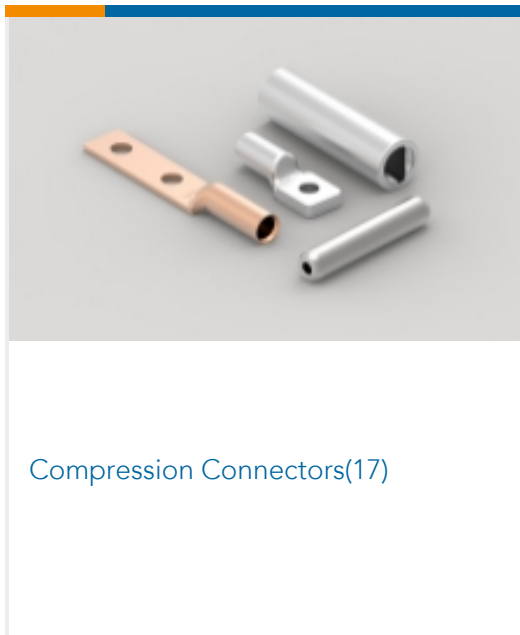

Customers Also Bought



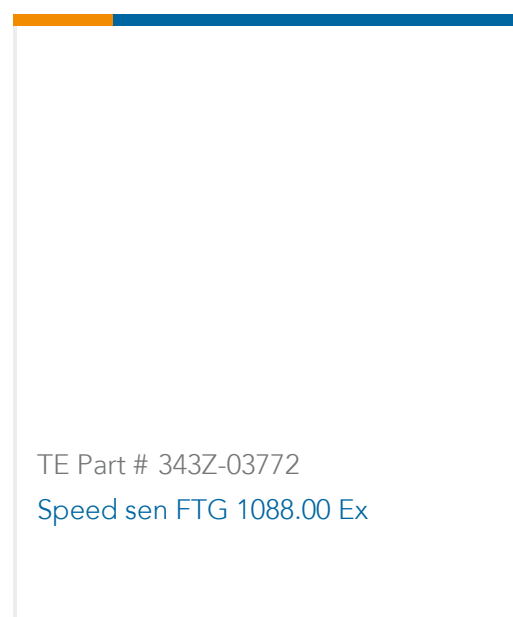
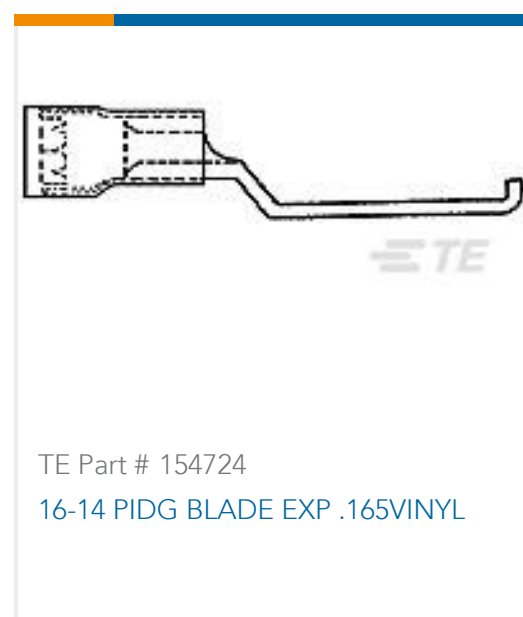

Documents

Product Drawings

PIDG WIRE PIN

English

CAD Files

3D PDF

3D

Customer View Model

[ENG_CVM_CVM_165172_P.2d_dxf.zip](#)

English

Customer View Model

[ENG_CVM_CVM_165172_P.3d_igs.zip](#)

English

Customer View Model

[ENG_CVM_CVM_165172_P.3d_stp.zip](#)

English

3D PDF

English

Customer View Model

[ENG_CVM_165172_J.2d_dxf.zip](#)

English

Customer View Model

[ENG_CVM_165172_J.3d_igs.zip](#)

English

Customer View Model

[ENG_CVM_165172_J.3d_stp.zip](#)

English

By downloading the CAD file I accept and agree to the [Terms and Conditions](#) of use.

Datasheets & Catalog Pages

PIDG TERMINALS & SPLICES Quick Reference Guide

English

Instruction Sheets

Instruction Sheet (U.S.)

English



[Agency Approvals](#)

[UL Report](#)

English