

符合"DLK环境管理物质技术标准"

符合"IEC协会标准"

工程变更通知单 ECN(DCN) NO.	版本 REV	日期 DATE	说明 DESCRIPTION	改变 CHANGE	承认 APPRO.
KSECN15012	B	20150428	1.增加DSB4PD-15LS1YN32料号 2.增加黑色料号 Δ B*2	王永辉	严成旺
KSECN16067	C	20160912	后盖增加逃料 Δ *1	万小龙	王永辉
KSECN19023	D	20190521	依实物将 3.45 ± 0.15 mm改为 $3.30^{+0.15}_{-0.15}$ mm Δ *1	王永辉	严成旺

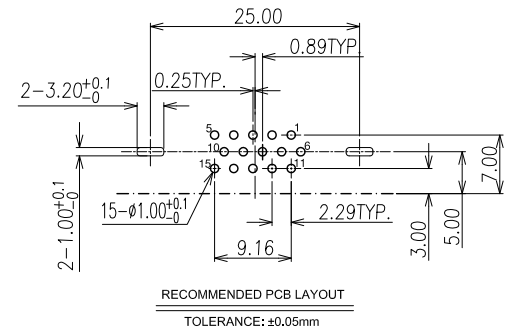
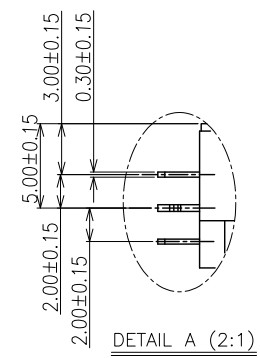
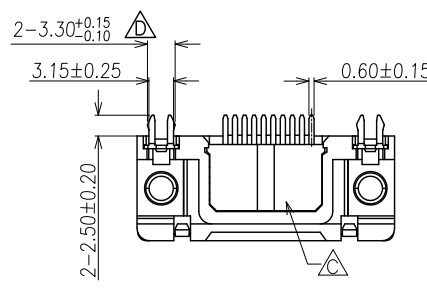
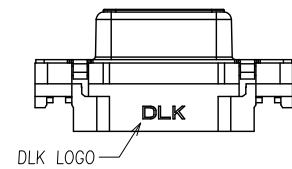
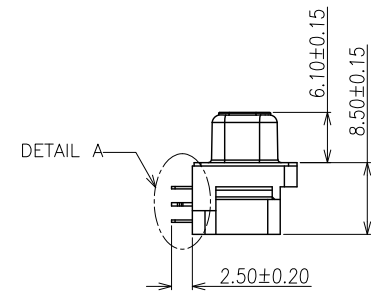
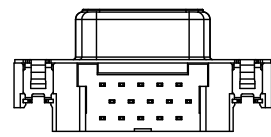
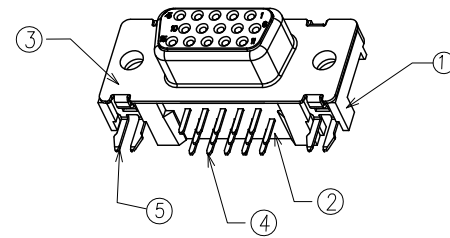
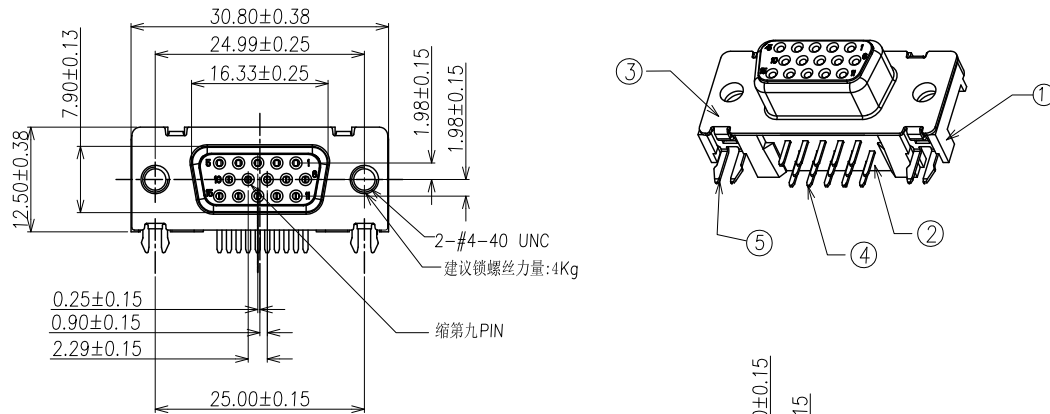

NOTE:

- MATERIAL:
 - Housing/Cover: PBT UL94v-0, color: Blue
 - Contact: Copper alloy
 - Shell: Ferro alloy
 - Rivet Insert:Ferro alloy
- PLATING:
 - Contact: 1u" Au plated on contact Area, 100u" Min. Matte Tin plated on solder tail, 50u" Min.Nickel underplated
 - Shell: Nickel plated overall
- MECHANICAL:
 - Insertion force:2.0~5.0kgf.
 - Withdrawal force:1.0Kgf Min.
 - Durability:500 cycles Min.
- ELECTRICAL:
 - Current Rating:1.0A
 - Voltage Rating:36V
 - Dielectric strength:500V AC FOR 1 minute
 - Insulation Resistance:1000MΩ Min.
 - Contact Resistance:30mΩ Max
 - Operating Temperature:-55°c to +105°c
- PACKING: Tray

NO.	ITEM	Q'TY	DESCRIPTION	FINISH
5	RIVET INSERT	2	FERROALLOY	Tin PLATED
4	Contact	15	COPPER ALLOY	Au And Tin plated
3	Shell	1	FERROALLOY	Ni PLATED
2	Cover	1	PBT	UL94V-0,BLUE/Black
1	Housing	1	PBT	UL94V-0,BLUE/Black

GENERAL TOLERANCE UNLESS OTHERWISE NOTED		德力康电子科技有限公司 DELIKANG ELECTRONICS TECHNOLOGY CO.,LTD			
Angle	±5'	C 名称 TITLE: D-SUB R/A 12.5H CONN			
X.	±0.35	FILE NAME:		C-DSB4P-00-00	料号 PART NO: 84P15L01320
.X	±0.25	DRAWING		王永辉	CHECKED
.XX	±0.15			APPROVED	严成旺
.XXX	±0.10	UNIT:		mm	SCALE
A4				1:1	SHEET: 1 of 1