

Cylindrical Inductive Long-Distance Proximity Sensors



PRD Series (IO-Link) PRODUCT MANUAL

For your safety, read and follow the considerations written in the instruction manual, other manuals and Autonics website.

The specifications, dimensions, etc. are subject to change without notice for product improvement. Some models may be discontinued without notice.

Features

- Reduced installation work by identifying object IDs
- Malfunction and damage prevention through status monitoring
- Shortest time recovery through abnormal detection
- Mode indicator for check status
 - IO-Link mode
 - : Communication indicator (flashing green), operation indicator (orange), abnormal detect indicator (cross-flashing green, orange)
 - SIO mode
 - : Operation indicator (orange), stable indicator (green), abnormal detect indicator (cross-flashing green, orange)
- IP67 Protection rating (IEC standard)

Safety Considerations

- Observe all 'Safety Considerations' for safe and proper operation to avoid hazards.
- ⚠ symbol indicates caution due to special circumstances in which hazards may occur.

⚠ Warning Failure to follow instructions may result in serious injury or death.

- 01. Fail-safe device must be installed when using the unit with machinery that may cause serious injury or substantial economic loss. (e.g. nuclear power control, medical equipment, ships, vehicles, railways, aircraft, combustion apparatus, safety equipment, crime/disaster prevention devices, etc.)**
Failure to follow this instruction may result in personal injury, economic loss or fire.
- 02. Do not use the unit in the place where flammable/explosive/corrosive gas, high humidity, direct sunlight, radiant heat, vibration, impact or salinity may be present.**
Failure to follow this instruction may result in explosion or fire.
- 03. Do not disassemble or modify the unit.**
Failure to follow this instruction may result in fire.
- 04. Do not connect, repair, or inspect the unit while connected to a power source.**
Failure to follow this instruction may result in fire.
- 05. Check 'Connections' before wiring.**
Failure to follow this instruction may result in fire.

⚠ Caution Failure to follow instructions may result in injury or product damage.

- 01. Use the unit within the rated specifications.**
Failure to follow this instruction may result in fire or product damage.
- 02. Use a dry cloth to clean the unit, and do not use water or organic solvent.**
Failure to follow this instruction may result in fire.
- 03. Do not supply power without load.**
Failure to follow this instruction may result in fire or product damage.

Cautions during Use

- Follow instructions in 'Cautions during Use'.
Otherwise, it may cause unexpected accidents.
- 12 - 24 VDC= power supply should be insulated and limited voltage/current or Class 2, SELV power supply device.
- Use the product, after 0.8 sec of supplying power.
- Wire as short as possible and keep away from high voltage lines or power lines, to prevent surge and inductive noise.
Do not use near the equipment which generates strong magnetic force or high frequency noise (transceiver, etc.).
In case installing the product near the equipment which generates strong surge (motor, welding machine, etc.), use diode or varistor to remove surge.
- This unit may be used in the following environments.
 - Indoors (UL Type 1 Enclosure)
 - Altitude max. 2,000 m
 - Pollution degree 3
 - Installation category II

Cautions for Installation

- Install the unit correctly with the usage environment, location, and the designated specifications.
- Do NOT impacts with a hard object or excessive bending of the wire lead-out. It may cause damage the water resistance.
- Do NOT pull the \varnothing 3.5 mm cable with a tensile strength of 25 N, the \varnothing 4 mm cable with a tensile strength of 30 N or over and the \varnothing 5 mm cable with a tensile strength of 50 N or over. It may result in fire due to the broken wire.
- When extending wire, use AWG 22 cable or over within 200 m.
In case of IO-Link mode, the cable length between the unit and the IO-Link Master should be under 20 m.
- Factory default is push-pull N.O. mode in SIO mode.
If logical connection (OR, AND) between sensors is required, set the output mode to NPN or PNP.

Ordering Information

This is only for reference, the actual product does not support all combinations.
For selecting the specified model, follow the Autonics website.

PRD ① ② - ③ ④ - ⑤ - ⑥

① Connection

No mark: Cable type
W: Cable connector type
CM: Connector type

② DIA. of sensing side

Number: DIA. of sensing side (unit: mm)

③ Sensing distance

Number: Sensing distance (unit: mm)

④ Power supply

D: 12 - 24 VDC=

⑤ Cable

No mark: Standard type
V: Oil resistant cable type

⑥ Communication

IL2: IO-Link COM2

Product Components

- Product × 1
- Nut × 2
- Instruction manual × 1
- Washer × 1

Sold Separately

- M12 Connector cable: C□DH4-□(-□)
- Spatter protection cover: P90-M□
- Fixing bracket: P90-R□

Communication Interface

■ IO-Link

Version	Ver. 1.1
Class	Class A
Baud rate	COM 2 (38.4 kbps)
Min. cycle time	2.3 ms
Data length	PD: 2 byte, OD: 1 byte (M-sequence: TYPE_2_2)
Vendor ID	899 (0x383)

Software

Download the installation file and the manuals from the Autonics website.

■ atIOLink

atIOLink with purposes for setting, diagnosis, and maintenance of IO-Link device via IODD file is provided as the Port and Device Configuration Tool (PDCT).

- IODD (IO Device Description)

This file contains information such as manufacturer information, process data, diagnostic data, and parameter setting of a sensor using IO-Link communication. By uploading the IODD file to PDCT Software, you can check the setting and communication data according to the user interface.
Download the IODD file from the Autonics website.

Circuits

① Brown	② White	③ Blue	④ Black
+L	I/Q ⁰¹⁾	L-	C/Q

01) The I/Q terminal is the inverted output of the C/Q terminal.
In case of IO-Link mode, I/Q terminal output turns OFF.

■ IO-Link mode

- The control output mode can be switched through parameter setting.

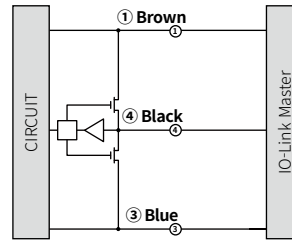

■ SIO mode

- The control output mode can be selected through load connection.
- Factory default
: Output type - Push-pull / Output mode - N.O.

• In case of NPN connection

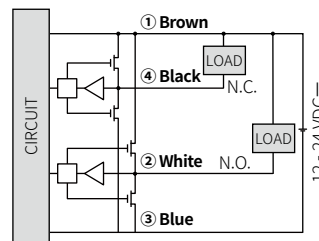

• In case of PNP connection

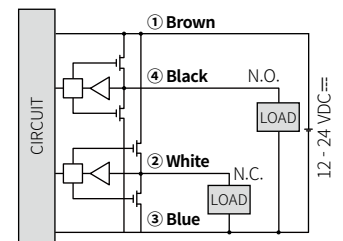

Connector Specification

- For LOAD connection, follow the cable type connection.
- Fasten the connector not to shown the thread. (0.39 to 0.49 N m)
- Fasten the vibration part with PTFE tape.



① Brown	② White	③ Blue	④ Black
+L	I/Q ⁰¹⁾	L-	C/Q

01) The I/Q terminal is the inverted output of the C/Q terminal.

Functions

■ Output-related functions

- IO-Link or SIO mode
(Parameter setting possible through software when IO-Link mode)
- Timer mode (Timer OFF (factory default) / ON Delay / OFF Delay / One Shot)
- Timer time (1 to 9999 ms)
- Too close target detection and unstable detection alarm
- Control output (Push-Pull / NPN / PNP)
- Output mode (N.O. (Normally Open) / N.C. (Normally Closed))
- Operating time save

■ Monitoring functions

- Power monitoring
- Output disconnection detection
- Coil disconnection detection
- Over temperature detection
- Operating time alarm
- Disturbance signal detection

Specifications

Installation	Flush type		
Model	PRD□12-4D-□-IL2	PRD□18-7D-□-IL2	PRD□30-15D-□-IL2
DIA. of sensing side	Ø 12 mm	Ø 18 mm	Ø 30 mm
Sensing distance	4 mm	7 mm	15 mm
Setting distance	0 to 2.8 mm	0 to 4.9 mm	0 to 10.5 mm
Hysteresis	≤ 10 % of sensing distance		
Standard sensing target: iron	12 × 12 × 1 mm	20 × 20 × 1 mm	45 × 45 × 1 mm
Response frequency ⁰¹⁾	500 Hz	250 Hz	100 Hz
Affection by temperature	≤ ± 10 % for sensing distance at ambient temperature 20 °C		
Indicator ⁰²⁾	IO-Link mode, SIO mode (varies by mode)		
IO-Link mode	Communication indicator (flashing green), operation indicator (orange), Abnormal detect indicator (cross-flashing green, orange)		
SIO mode	Operation indicator (orange), stable indicator (green), Abnormal detect indicator (cross-flashing green, orange)		
Approval	CE		

- 01) The response frequency is the average value. The standard sensing target is used and the width is set as 2 times of the standard sensing target, 1/2 of the sensing distance for the distance.
- 02) In case of SIO mode, use the device within the range where the stable indicator (green) is ON.
If the sensing target is in the too close detection distance, the stable indicator turns OFF, but it is in a stable detection state.
In case of IO-Link mode, use the device within the range where unstable detection (Byte0_bit6) turns 0.
If the sensing target is in the too close detection distance, the too close detection (Byte0_bit5) is 1, but it is a stable detection state.

Installation	Non-flush type		
Model	PRD□12-8D-□-IL2	PRD□18-14D-□-IL2	PRD□30-25D-□-IL2
DIA. of sensing side	Ø 12 mm	Ø 18 mm	Ø 30 mm
Sensing distance	8 mm	14 mm	25 mm
Setting distance	0 to 5.6 mm	0 to 9.8 mm	0 to 17.5 mm
Hysteresis	≤ 10 % of sensing distance		
Standard sensing target: iron	25 × 25 × 1 mm	40 × 40 × 1 mm	75 × 75 × 1 mm
Response frequency ⁰¹⁾	400 Hz	200 Hz	100 Hz
Affection by temperature	≤ ± 10 % for sensing distance at ambient temperature 20 °C		
Indicator ⁰²⁾	IO-Link mode, SIO mode (varies by mode)		
IO-Link mode	Communication indicator (flashing green), operation indicator (orange), Abnormal detect indicator (cross-flashing green, orange)		
SIO mode	Operation indicator (orange), stable indicator (green), Abnormal detect indicator (cross-flashing green, orange)		
Approval	CE		

- 01) The response frequency is the average value. The standard sensing target is used and the width is set as 2 times of the standard sensing target, 1/2 of the sensing distance for the distance.
- 02) In case of SIO mode, use the device within the range where the stable indicator (green) is ON.
If the sensing target is in the too close detection distance, the stable indicator turns OFF, but it is in a stable detection state.
In case of IO-Link mode, use the device within the range where unstable detection (Byte0_bit6) turns 0.
If the sensing target is in the too close detection distance, the too close detection (Byte0_bit5) is 1, but it is a stable detection state.

Unit weight (package)	Ø 12 mm	Ø 18 mm	Ø 30 mm
Cable	≈ 62 g (≈ 74 g)	≈ 97 g (≈ 115 g)	≈ 143 g (≈ 180 g)
Cable connector	≈ 37 g (≈ 67 g)	≈ 62 g (≈ 80 g)	≈ 108 g (≈ 145 g)
Connector	≈ 20 g (≈ 49 g)	≈ 41 g (≈ 81 g)	≈ 138 g (≈ 197 g)

Power supply	12 - 24 VDC≐ (ripple P-P: ≤ 10 %), operating voltage: 10 - 30 VDC≐
Current consumption	IO-Link mode: ≤ 25 mA, SIO mode: ≤ 20 mA
Control output	≤ 100 mA
Residual voltage ⁰¹⁾	≤ 2 V
Protection circuit	Surge protection circuit, output short over current protection circuit, reverse polarity protection
Insulation resistance	≥ 50 MΩ (500 VDC≐ megger)
Dielectric strength	Between the charging part and the case: 1,000 VAC~ 50 / 60 Hz for 1 min
Vibration	1.5 mm double amplitude at frequency 10 to 55 Hz in each X, Y, Z direction for 2 hours
Shock	1000 m/s ² (≈ 100 G) in each X, Y, Z direction for 3 times
Ambient temp. ⁰²⁾	-25 to 70 °C, storage: -25 to 70 °C (no freezing or condensation)
Ambient humi.	35 to 95 %RH, storage: 35 to 95 %RH (no freezing or condensation)
Protection rating	IP67 (IEC standard)
Connection	Cable / Cable connector / connector models
Cable spec. ⁰³⁾	DIA. of sensing side Ø 12 mm: Ø 4 mm, 4-wire DIA. of sensing side Ø 18 mm, Ø 30 mm : Ø 5 mm, 4-wire
Wire spec.	AWG 22 (0.08 mm, 60-core), insulator diameter: Ø 1.25 mm
Connector spec.	M12 plug connector
Material	Standard type cable (black): polyvinyl chloride (PVC), Oil resistant cable (gray): polyvinyl chloride (oil resistant PVC), case / nut: nickel plated brass, washer: nickel plated iron, sensing side: PBT

- 01) Load current: 100 mA, cable length: 2 m
02) UL approved surrounding air temperature 40 °C
03) Cable type: 2 m, Cable connector type: 300 mm

Operation Timing Chart

- Refer to the Setting Distance Formula for the unstable detection area and the too close detection distance.

IO-Link mode

- Operates by setting value

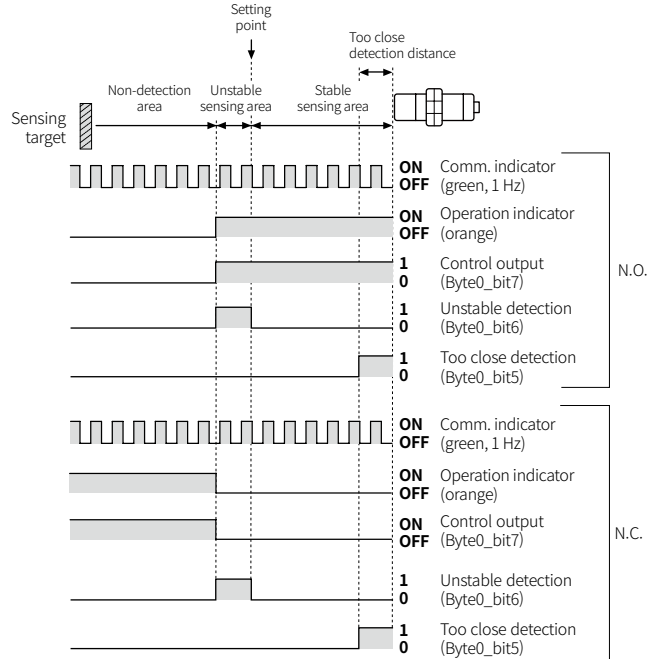

SIO mode

- Operates by factory default (output type - push-pull / output mode - N.O.)
- In the output mode to N.C., the waveforms are reversed.
- Unstable sensing area: 70 % of max. sensing distance, too close detection distance: 20 % of max. sensing distance. (factory default)

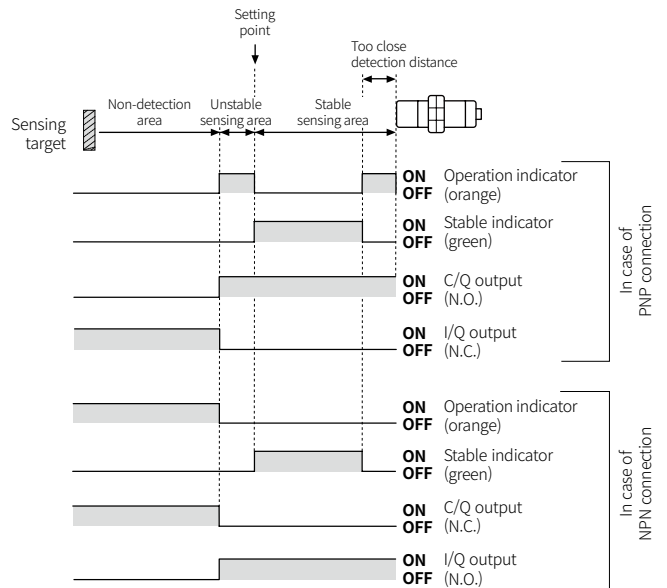

- Example of timer set
T: Timer time (1 to 9999 ms)

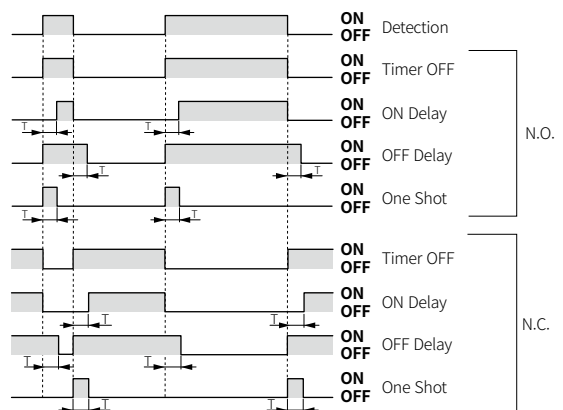

Parameter Index

■ Process data

- The current data value is displayed in real time.

Parameter	Byte0 (PD0)	Byte1 (PD1)	Format	Setting range	Description
Detection Level	-	7 to 0	UInteger	0 to 255	Outputs the detection signal value as specific 8 bit.
Warning	4	-	Boolean	0: Normal (OFF), 1: Warning (ON)	Outputs diagnosing items defined as dangerous.
Target too Close Alarm	5	-	Boolean	0: Not Close, 1: Too Close	Outputs close range detection status.
Instability Detection Alarm	6	-	Boolean	0: Stable, 1: Unstable	Outputs instability detection status.
Sensor Output	7	-	Boolean	0: OFF, 1: ON	Displays sensor's output status. (C/Q terminal)

■ Identification menu

- The device's manufacturer information and sensor information is displayed. It includes additionally information of companies and sensors from the IO-Link standard.

Parameter	Index	Format	R / W	Description
Vendor Name	16	String	RO	Manufacturer name
Vendor Text	17	String	RO	Manufacturer description
Product Name	18	String	RO	Product name
Product ID	19	String	RO	Product ID
Product Text	20	String	RO	Product description
H/W Version	22	String	RO	Hardware version
F/W Version	23	String	RO	Firmware version
Application specific tag	24	String	RW	Application program tag

■ Observation menu

- The device setting value is displayed.

Parameter	Index	R / W	Description	
Operating Hours	-	72	RO	Sensor operation time
Process Data Input	Detection level	40	RO	Current value
	Warning		RO	Warning
	Target too close alarm		RO	Too close detection
	Instability detection alarm		RO	Unstable detection
	Sensor output		RO	Sensor output

■ Parameter menu

- Product settings such as output mode and timer can be changed according to the user environment.

Parameter	Index	Sub-index	Format	R / W	Description	Setting range	Factory default
Output Setup	64	1	UInteger	RW	Output mode	0: N.O. (Normally Open), 1: N.C. (Normally Closed)	0
		2	UInteger	RW	Output type	0: Push-Pull, 1: NPN, 2: PNP	0
Timer	66	1	UInteger	RW	Timer mode	0: Timer OFF, 1: ON Delay, 2: OFF Delay, 3: One Shot	0
		2	UInteger	RW	Timer time	1 to 9,999 ms	5 ms
Target too Close	65	-	UInteger	RW	Margin according to the target material	0: Disable, 1: Iron 10 %, 2: Iron 20 %, 3: Iron 30 %, 4: SUS 10 %, 5: SUS 20 %, 6: SUS 30 %, 7: Aluminum 10 %, 8: Aluminum 20 %	2
Instability Detection Alarm	68	-	UInteger	RW	Output timing when instable detection	0: 0 ms, 1: 10 ms, 2: 50 ms, 3: 100 ms, 4: 300 ms, 5: 500 ms, 6: 1000 ms	4
Operating Hours Alarm Setting	74	-	UInteger	RW	Operating Hours Alarm Setting	0 to 131,071 hour	100,000
Restore Factory Settings	2	-	UInteger	WO	Factory default reset	130: Restore factory setting	-
Data Storage Lock	12	2	Record	RW	Data storage locked between IO-Link Master-Device	0: false, 1: true	0

■ Diagnosis Menu

- The information about problems encountered during sensor operation is displayed.

Parameter	Index	Format	R / W	Description	
Operating Hours	-	72	UInteger	RO	Sensor operation time
Process Data Input	Detection Level	40	UInteger	RO	Current value
	Warning		Boolean	RO	Warning
	Target too Close Alarm		Boolean	RO	Too close detection
	Instability Detection Alarm		Boolean	RO	Unstable detection
	Sensor Output		Boolean	RO	Sensor output
Detailed Device Status	-	37	Record	RO	Sensor detailed status

■ Events

- When the corresponding error occurs, the abnormal indicator flashes.

Event name	Event code	Type	Description
Warning	6145 (0x1801)	Coil Disconnection	Coil disconnection detection warning
	6146 (0x1802)	Short Circuit	Overcurrent detection warning
	6147 (0x1803)	Over Temperature	Overheat detection warning
	6148 (0x1804)	Supply Under Voltage	Low voltage detection warning
	6149 (0x1805)	Operation Time Alarm	Operation time alarm warning
	6150 (0x1806)	Disturbance Error	Disturbance signal detection warning
	6152 (0x1808)	EEPROM Error	EEPROM error warning
Error	6151 (0x1807)	Parameter Setting Error	Parameter setting error

Cut-out Dimensions

• Unit: mm, For the detailed drawings, follow the Autonics website.

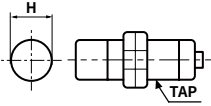

	Ø 12 mm	Ø 18 mm	Ø 30 mm
Mounting hole (H)	Ø 12.5 ^{+0.5} ₀	Ø 18.5 ^{+0.5} ₀	Ø 30.5 ^{+0.5} ₀
TAP	M12×1	M18×1	M30×1.5

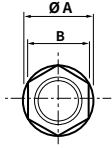

	Ø 12 mm	Ø 18 mm	Ø 30 mm
Ø A	21	29	42
B	17	24	35

Setting Distance Formula

Detecting distance can be changed by the shape, size or material of the target.

For stable sensing, install the unit within the 70% of sensing distance.

Setting distance (Sa)

= Sensing distance (Sn) × 70%

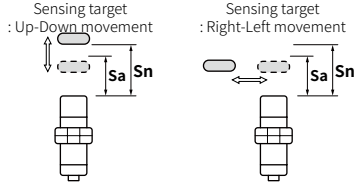

Mutual-interference & Influence by Surrounding Metals

■ Mutual-interference

When plural proximity sensors are mounted in a close row, malfunction of sensor may be caused due to mutual interference.

Therefore, be sure to provide a minimum distance between the two sensors, as below table.

[Face to Face]

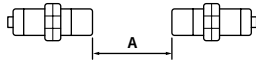

[Parallel]

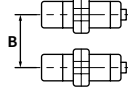

■ Influence by surrounding metals

When sensors are mounted on metallic panel, it must be prevented sensors from being affected by any metallic object except target. Therefore, be sure to provide a minimum distance as below chart.

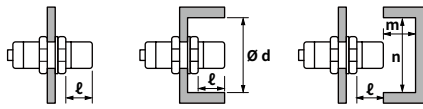

(Unit: mm)

Sensing side	Ø 12 mm		Ø 18 mm		Ø 30 mm	
	Flush	Non-flush	Flush	Non-flush	Flush	Non-flush
A	25	120	50	200	110	350
B	25	100	35	110	90	300
ℓ	2.5	15	3.5	14	6	20
Ø d	18	40	27	70	45	120
m	12	20	24	40	45	90
n	18	40	27	70	45	120

Tightening Torque

Use the provided washer to tighten the nuts.

The tightening torque of the nut varies with the distance from the fore-end. [Figure 1]

If the nut tip is located at the front of the product, apply the front tightening torque.

The allowable tightening torque table is for inserting the washer as [Figure 2].

[Figure 1]

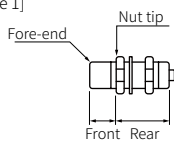

[Figure 2]

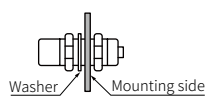

Sensing side	Ø 12 mm		Ø 18 mm		Ø 30 mm	
	Flush	Non-flush	Flush	Non-flush	Flush	Non-flush
Strength						
Front size	13 mm	7 mm	-	-	26 mm	12 mm
Front torque	6.37 N m		14.7 N m		49 N m	
Rear torque	11.76 N m		14.7 N m		78.4 N m	

Sensing Distance Feature Data by Target Material and Size

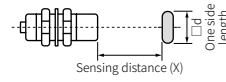

■ Flush type

• Ø 12 mm

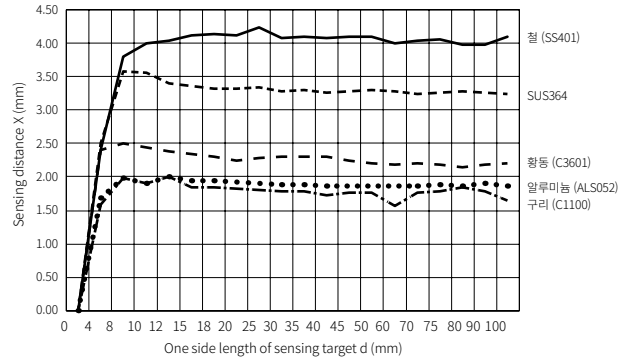

• Ø 18 mm

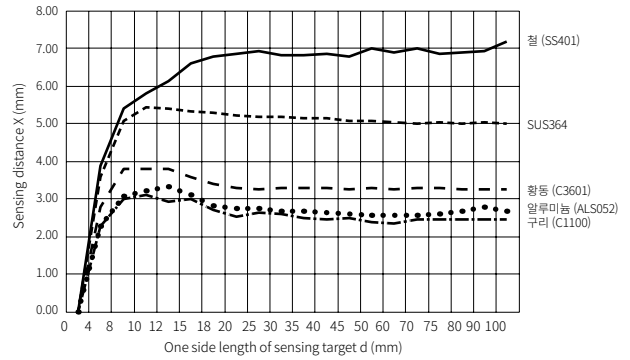

• Ø 30 mm

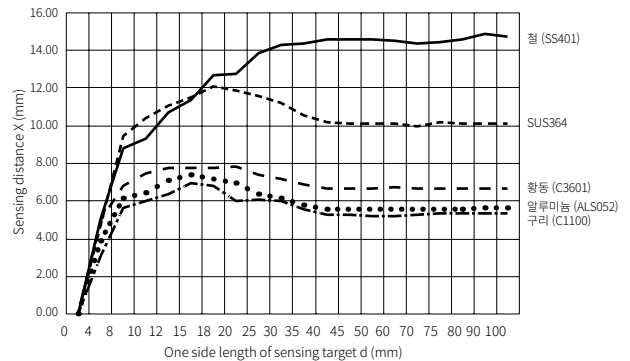

■ Non-flush type

• Ø 12 mm

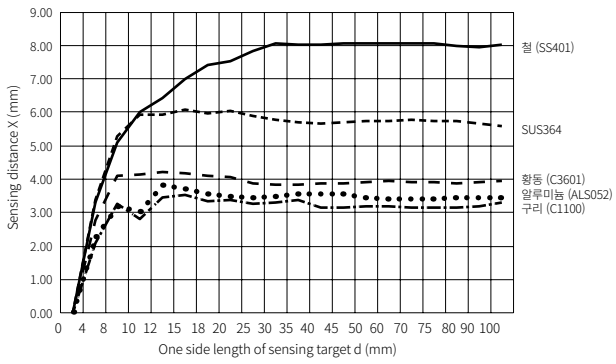

• Ø 18 mm

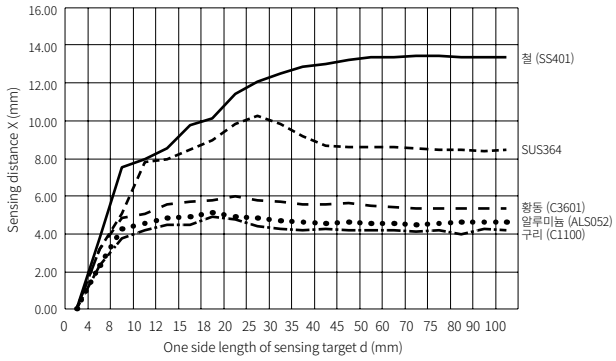

• Ø 30 mm

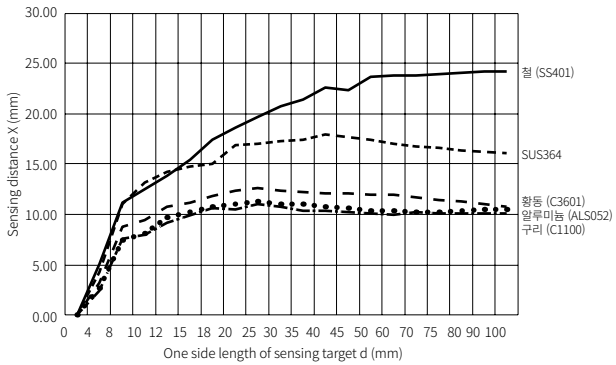

Sensing Distance Feature Data by Parallel (left/right) Movement

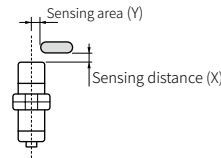

—	Flush type
- - -	Non-flush type

• Ø 12 mm

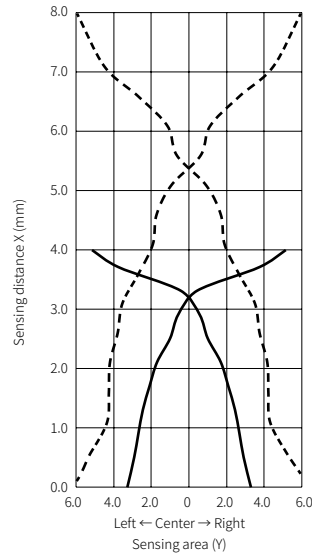

• Ø 18 mm

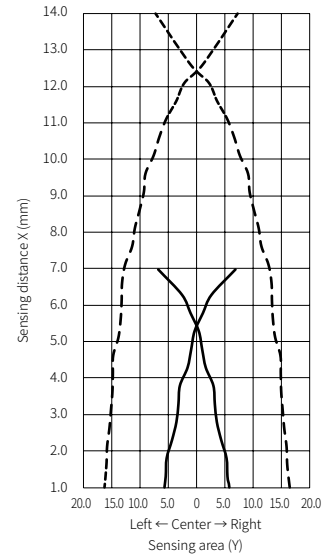

• Ø 30 mm

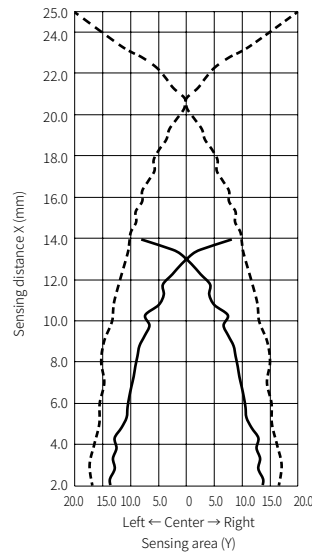

Sold Separately: M12 Connector Cable

• For detailed information, refer to the 'M8/M12 Connector Cable' manual.

Appearance	Power	Connector 1	Connector 2	Length	Feature	Model
	DC	M12 (Socket-Female) 4-pin	4-wire	2 m	Oil resistant PVC	CIDH4-2
				3 m		CIDH4-3
				5 m		CIDH4-5
				7 m		CIDH4-7
	DC	M12 (Socket-Female) 4-pin	4-wire	2 m	Oil resistant PVC	CIDH4-2-A
				3 m		CIDH4-3-A
				5 m		CIDH4-5-A
				7 m		CIDH4-7-A
	DC	M12 (Socket-Female) 4-pin, L type	4-wire	2 m	Oil resistant PVC	CLDH4-2
				3 m		CLDH4-3
				5 m		CLDH4-5
				7 m		CLDH4-7
	DC	M12 (Socket-Female) 4-pin, L type	4-wire	2 m	Oil resistant PVC	CLDH4-2-A
				3 m		CLDH4-3-A
				5 m		CLDH4-5-A
				7 m		CLDH4-7-A
	DC	M12 (Socket-Female) 4-pin	M12 (Plug-Male) 4-pin	1 m	Oil resistant PVC	C1DH4-1
				3 m		C1DH4-3
				5 m		C1DH4-5
				7 m		C1DH4-7
	DC	M12 (Socket-Female) 4-pin, L type	M12 (Plug-Male) 4-pin, L type	1 m	Oil resistant PVC	C2DH4-1
				3 m		C2DH4-3
				5 m		C2DH4-5
				7 m		C2DH4-7
	DC	M12 (Socket-Female) 4-pin	M12 (Plug-Male) 4-pin, L type	1 m	Oil resistant PVC	C3DH4-1
				3 m		C3DH4-3
				5 m		C3DH4-5
				7 m		C3DH4-7
	DC	M12 (Socket-Female) 4-pin, L type	M12 (Plug-Male) 4-pin	1 m	Oil resistant PVC	C4DH4-1
				3 m		C4DH4-3
				5 m		C4DH4-5
				7 m		C4DH4-7

Sold Separately: Protection Cover (P90-M□)

The welding tip (spatter) generated during arc welding has a property of sticking to plastics and metals. If several welding tips are attached to the front or body of the proximity sensor, it may be difficult to replace the body or cause a malfunction. When using a general type proximity sensor, use a silicone protective cover (sold separately). Only for flush (shield) type.

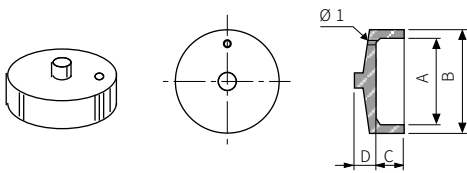

Item (mm)	Model	P90-M12	P90-M18	P90-M30
A		Ø 11	Ø 17	Ø 28.5
B		Ø 14	Ø 21	Ø 33
C		5.0	6.0	8.0
D		1.0	3.0	6.0
Applied sensing side size		M12	M18	M30

Sold Separately: Fixing Bracket (P90-R□)

If fixing holes are not made for cylindrical proximity sensor, use a cylindrical fixing bracket as below. For Non-flush (non-shield) type, be sure effect by ambient material.

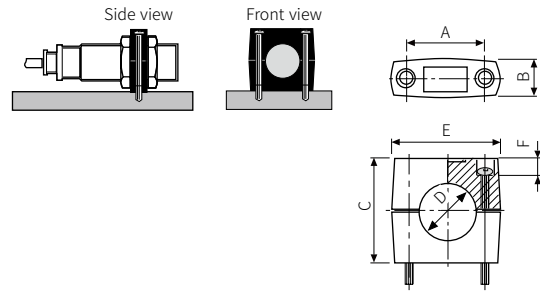

Item (mm)	Model	P90-R12	P90-R18	P90-R30
A		24 ± 0.2	32 ± 0.2	45 ± 0.2
B		≤ 11.5	≤ 16	≤ 16
C		20	30	50
D		Ø 12	Ø 18	Ø 30
E		≤ 34.4	≤ 47	≤ 60
F		6.0	10	10
Fixing bolt		M4 × 20	M5 × 30	M5 × 50
Applied sensing side size		M12	M18	M30