

符合DLK环境管理物质技术标准 符合HDMI协会规范

工程变更通知单 ECN(DCN) NO.	版本 REV	日期 DATE	说明 DESCRIPTION	改变 CHANGE	承认 APPRO.
KSECN23020	A	20230504	NEW RELEASE	—	—

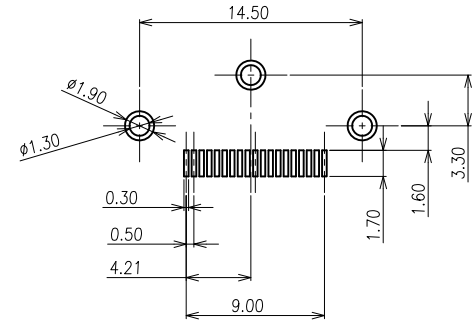

PCB LAYOUT(TOP VIEW)
(T=1.60mm)

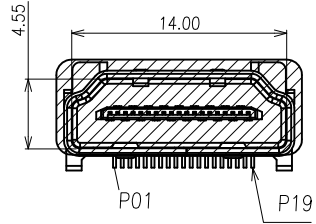
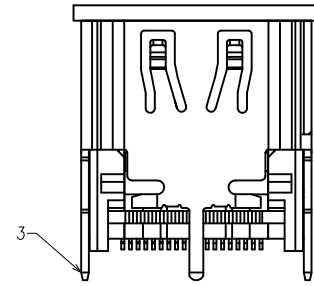
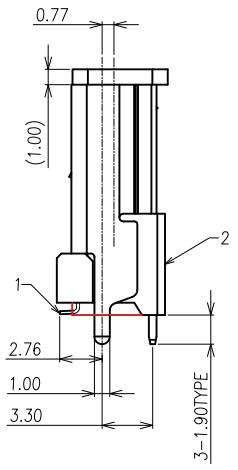
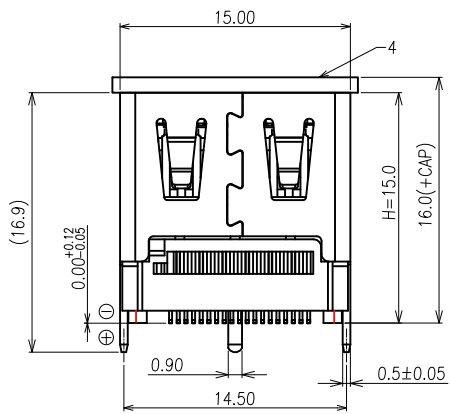

NOTE:
 1. MATERIAL:
 1.1 Housing: LCP UL94v-0, color: Black
 1.2 Contact: Copper alloy
 1.3 Shell: Stainless steel
 2. PLATING:
 2.1 Contact: Au plated on contact Area, 50u" Min.Nickel underplated
 2.2 Shell: Nickel plated overall
 3. MECHANICAL:
 3.1 Mating force:4.5kgf Max.
 3.2 Unmating force:1.0~4.0kgf.
 3.3 Durability:10000 cycles Min.
 4. ELECTRICAL:
 4.1 Current Rating:0.5A
 4.2 Voltage Rating:40V
 4.3 Dielectric strength:500V AC FOR 1 minute
 4.4 Insulation Resistance:100MΩ Min.
 4.5 Contact Resistance:10mΩ Max
 5. Operating Temperature:-55°C to +105°C
 6. PACKING: Tape & Reel

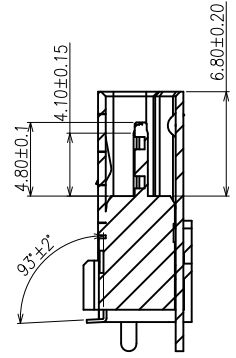
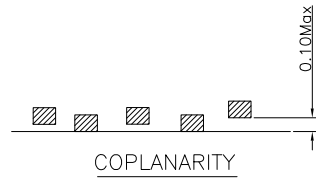
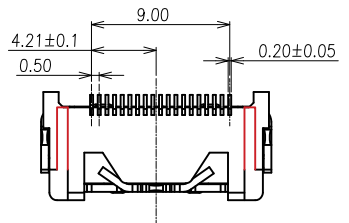

4	COVER	1	LCP	UL94V-0,Black
3	SHELL	1	Stainless steel	PLATED NI
2	HOUSING	1	LCP	UL94V-0,Black
1	CONTACT	19	Copper alloy	PLATED Au AND MATTE TIN
NO.	ITEM	Q'TY	DESCRIPTION	FINISH

GENERAL TOLERANCE UNLESS OTHERWISE NOTED	
Angle	±5°
X.	±0.35
.X	±0.25
.XX	±0.15
.XXX	±0.10
A4	

德力康电子科技有限公司
DLK DELIKANG ELECTRONICS TECHNOLOGY CO.,LTD

C 名称 TITLE:	HDMI2.0 A/F V/T 15H 19Pin CONN.			
档案名称 FILE NAME:	C-HDM2A-00-03	料号 PART NO.:	52A19B11131	
DRAWING	蒋召	CHECKED	覃智森	APPROVED 吴豪
UNIT:	mm	SCALE	1:1	SHEET: 1 of 1