

Hall-Effect-Based Current Sensor IC with Common-Mode Field Rejection and Overcurrent protection

Datasheet (EN) 1.0

Product Overview

NSM2015 is an integrated path current sensor with a very low on-resistance of 0.85mΩ, reducing heat loss on the chip.

NOVOSENSE innovative isolation technology and signal conditioning design can meet high isolation levels while sensing the current flowing through the internal Busbar. A differential Hall pair is used internally, so it has a strong immunity to external stray magnetic fields.

NSM2015 senses the magnetic field generated by the Busbar current flowing under the chip to indirectly detect the current. Compared with the current sampling method of the Shunt+ isolated op-amp, NSM2015 eliminates the need for the primary side power supply and has a simple and convenient layout. At the same time, it has extremely high isolation withstand voltage and Lifetime stability.

In high-side current monitoring applications, NSM2015 can reach a working voltage of 1550Vpk, and it can withstand 10kV surge voltage and 13kA surge current without adding any protection devices.

NSM2015 has a pseudo-differential output mode (fixed output), the output voltage will not change within a certain supply voltage, eliminating LDO on the system, making BOM simpler.

Due to NSM2015 internal accurate temperature compensation algorithm and factory accuracy calibration, this current sensor can maintain good accuracy in the full temperature working range, and the customer does not need to do secondary programming or calibration.

NSM2015 Provides overcurrent protect function and supports adjusting the overcurrent threshold.

Support 3.3V/5V power supply (different version)

Key Features

- High bandwidth and fast response time
- 320kHz bandwidth
- 1.5us response time
- High-precision current measurement

- Differential Hall sets can immune stray field
- High isolation level that meets UL standards
- Working Voltage for Basic Isolation (VWVBI): 1550Vpk / 1097Vrms
- Withstand isolation voltage (VISO): 5000Vrms
- Maximum surge isolation withstand voltage (VIOSM): 10kV
- Maximum surge current (Isurge): 13kA
- CMTI > 100V/ns
- CTI (I)
- Creepage distance/Clearance distance: 8mm
- Fault Overcurrent Protection
- NOVOSENSE innovative 'Spin Current' technology makes offset temperature drift very small
- Fixed output with Vref
- Working temperature: -40°C ~ 125°C
- Primary internal resistance: 0.85mΩ
- Wide body SOIC16 package
- UL62368/EN62368 safety certification
- ROHS
- AEC-Q100



Applications

- Solar system
- Industrial power supply
- Motor control
- OBC/DCDC/PTC Heater
- Charging pile

Device Information

Part Number	Package	Body Size
NSM2015	WB SOIC16	10.30mm × 7.50mm

Functional Block Diagrams

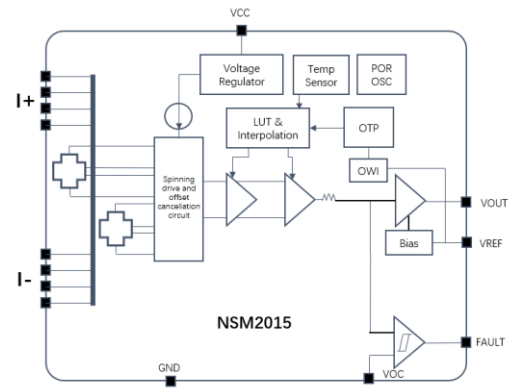

Figure 1. NSM2015 Block Diagram

INDEX

1. PIN CONFIGURATION AND FUNCTIONS	4
2. ABSOLUTE MAXIMUM RATINGS.....	5
3. ISOLATION CHARACTERISTICS	5
4. SPECIFICATIONS	6
4.1. COMMON CHARACTERISTICS (TA= -40°C TO 125°C, VCC = 5V OR 3.3V, UNLESS OTHERWISE SPECIFIED).....	6
4.2. NSM2015-50B5F-Q1SWR CHARACTERISTICS (TA= -40°C TO 125°C, VCC = 5V, UNLESS OTHERWISE SPECIFIED)	7
4.3. NSM2015-40B5F-Q1SWR CHARACTERISTICS (TA= -40°C TO 125°C, VCC = 5V, UNLESS OTHERWISE SPECIFIED)	8
4.4. NSM2015-66B5F-Q1SWR CHARACTERISTICS (TA= -40°C TO 125°C, VCC = 5V, UNLESS OTHERWISE SPECIFIED)	8
4.5. NSM2015-20B5F-Q1SWR CHARACTERISTICS (TA= -40°C TO 125°C, VCC = 5V, UNLESS OTHERWISE SPECIFIED)	9
4.6. NSM2015-80B3F-Q1SWR CHARACTERISTICS (TA= -40°C TO 125°C, VCC = 3.3V, UNLESS OTHERWISE SPECIFIED)	10
4.7. NSM2015-40B3F-Q1SWR CHARACTERISTICS (TA= -40°C TO 125°C, VCC = 3.3V, UNLESS OTHERWISE SPECIFIED)	11
4.8. NSM2015-66B3F-Q1SWR CHARACTERISTICS (TA= -40°C TO 125°C, VCC = 3.3V, UNLESS OTHERWISE SPECIFIED)	11
4.9. NSM2015-100B5F-Q1SWR CHARACTERISTICS (TA= -40°C TO 125°C, VCC = 5V, UNLESS OTHERWISE SPECIFIED)	12
5. FUNCTION DESCRIPTION	14
5.1. OVERVIEW	14
5.2. NSM2015 F VERSION(FIXED OUTPUT)	14
5.3. OVERCURRENT FAULT PERFORMANCE	14
5.4. NSM2015 POWER-ON TIME WAVE	15
5.5. NSM2015 RISE TIME AND RESPONSE TIME WAVE	17
5.6. NSM2015 BANDWIDTH TEST	19
5.7. DEFINITION OF NSM2015 TERMS	20
6. APPLICATION NOTE	22
6.1. TYPICAL APPLICATION CIRCUIT	22
6.2. PCB LAYOUT.....	22
6.3. THERMAL EVALUATION	23
7. PACKAGE INFORMATION.....	24
8. ORDER INFORMATION	25
9. TAPE AND REEL INFORMATION	26
10. REVISION HISTORY	27

1. Pin Configuration and Functions

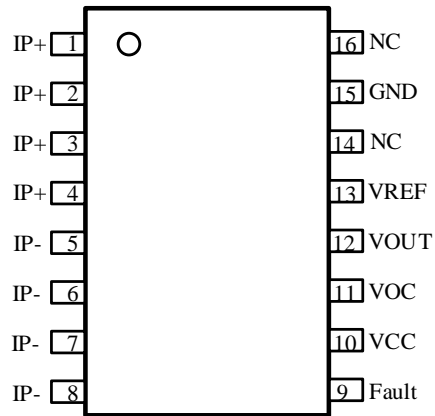

Figure 1.1 NSM2015 Package

Table 1.1 NSM2015 Pin Configuration and Description

NSM2015 PIN NO.	SYMBOL	FUNCTION
1-4	IP+	Current flows into the chip, positive direction
5-8	IP-	Current flows out of the chip, negative direction
9	FAULT	Overcurrent Fault, Active low, Open Drain Output
10	VCC	Power supply
11	VOC	Set the output overcurrent protection point
12	VOUT	Output voltage
13	VREF	Reference voltage output
14	NC	Not connection (Internal circuit connection, this pin can be connected to VCC or GND)
15	GND	Ground
16	NC	Not connection (Internal circuit connection, this pin can be connected to VCC or GND)

2. Absolute Maximum Ratings

Parameters	Symbol	Min	Typ	Max	Unit	Comments
V _{CC}	V _{CC}	-0.3		6.5	V	25°C
V _{out} /V _{ref}		-0.3		VDD+0.3	V	25°C
Others Pin		-0.3		VDD+0.3	V	25°C
Storage temperature	T _{Storage}	-40		150	°C	
Ambient temperature	T _{operation}	-40		125	°C	
Junction temperature	T _j	-40		150	°C	
ESD	V _{HBM}		±8		kV	
	V _{CDM}		±2		kV	
	Latch-up		±500		mA	

3. Isolation Characteristics

Parameters	Symbol	Rating	Unit	Comments
Surge Voltage	V _{surge}	10	kV	Based on IEC61000-4-5 1.2us/50us waveform
Surge Current	I _{surge}	13	kA	Based on IEC61000-4-5 8us/20us waveform
Dielectric Strength Test Voltage	V _{ISO}	5000	V _{rms}	60s isolation voltage parameters, according to UL62368-1, 6kV/ 1S insulation performance will be tested before delivery, and partial discharge is verified to be less than 5pC
Working Voltage for Basic Isolation	V _{WVBI}	1097	V _{rms}	Maximum approved working voltage for basic isolation according to UL60950-1 and UL62368-1
		1550	V _{dc}	
Common-mode transient immunity	CMTI	>100	V/ns	The criterion for judging the failure is that the output peak is greater than 100mV and the duration is longer than 1us
Creepage	Creepage	8	mm	Minimum Creepage
Clearance	Clearance	8	mm	Minimum Clearance
Comparative Tracking Index	CTI	>=600		CTI I

4. Specifications

4.1. Common Characteristics (TA= -40°C to 125°C, VCC = 5V or 3.3V, unless otherwise specified)

Parameters	Symbol	Min	Typ	Max	Unit	Comments
Supply voltage	V _{CC}	3	3.3	3.6	V	3.3V version
		4.5	5	5.5	V	5V version
Supply current	I _{CC}		12	15	mA	No load, V _{CC} =5V, 'F' version
Primary conductor resistance	R _p		0.85		mΩ	T _A = 25 °C
Power-on time	T _{po}		1		ms	Recommend customer to read output after 1ms power-on time, before 1ms internal OTP is loading, T _A = 25 °C
Output capacitance load ^{[1][2]}	C _L			10	nF	
Output resistance load ^{[1][2]}	R _L	10			kΩ	
Output short current	I _{short}			±30	mA	Short to VCC and short to GND, T _A = 25 °C
Rail to Rail output voltage ^{[1][2]}	V _s	0.1		VCC-0.1	V	T _A = 25 °C, C _L =1nF, R _L =10K to VCC or GND
Common mode field rejection ^{[1][2]}	CMFR		>40		dB	
Power supply rejection ratio	PSRR		-50		dB	DC to 1 kHz, 100 mV pk-pk ripple around VCC =5V, IP=0A
Rise time ^{[1][2]}	T _r		1.2		us	T _A = 25 °C, C _L =1nF, VCC=5V, 50AB "F"Version
Propagation delay ^{[1][2]}	T _{pd}		1.2		us	T _A = 25 °C, C _L =1nF, VCC=5V, 50AB "F"Version
Response time ^{[1][2]}	T _{response}		1.5	3	us	T _A = 25 °C, C _L =1nF, VCC=5V, 50AB "F"Version
Bandwidth ^{[1][2]}	BW		320		kHz	-3dB bandwidth, T _A = 25 °C, C _L =1nF, VCC=5V, 50AB, "F"Version
Noise density ^{[1][2]}	ND		260		uArms/ √Hz	T _A = 25 °C, C _L =1nF, VCC= 5V
Non-linearity	E _{NL}		±0.2		%	
Reference voltage	V _{ref}	2.49	2.5	2.51	V	FB Version, V _{CC} =5V
		1.64	1.65	1.66	V	FB Version, V _{CC} =3.3V
		0.49	0.5	0.51	V	FU Version, V _{CC} =5V
		0.32	0.33	0.34	V	FU Version, V _{CC} =3.3V
Fault pull-up Resistance	R _{pu}	4.7		100	kΩ	

Parameters	Symbol	Min	Typ	Max	Unit	Comments
Overcurrent threshold	I _{ft}	75		200	%IPR	
VOC Voltage range	V _{voc}	0.5		2	V	V _{cc} =5V
		0.33		1.32	V	V _{cc} =3.3V
VOC resistance load	C _{voc}			1	nF	
Fault Hysteresis	I _{hys}		10		%IPR	TA = 25°C, CL=1nF, NSM2015-50B5F, I _{ft} threshold=100%IPR
Fault Response time	T _{fr}		1.5		us	The time from Overcurrent happened to Fault pin active low, 4.7 kΩ pull-up Resistance
Fault Error			±8		%IPR	TA = 25°C, CL=1nF, NSM2015-50B5F, I _{ft} threshold=100%IPR

[1]: Design by Guarantee

[2]: Guaranteed by Bench Validation

[3]: The increase or decrease of data in 4.X will not send a PCN to the customer if the evaluation does not affect the customer's use.

4.2. NSM2015-50B5F-Q1SWR Characteristics (TA= -40°C to 125°C, VCC = 5V, unless otherwise specified)

Parameters	Symbol	Min	Typ	Max	Unit	Comments
Current sensing range	I _{pr}	-50		50	A	
Sensitivity	Sens		40		mV/A	I _{prmin} < I _{pr} < I _{prmax}
Zero current output voltage	V _{OVO}		2.5		V	I _{pr} =0A
Sensitivity error ^{[1][2]}	E _{sens}	-2		2	%	TA = 25°C~125°C
		-2		2	%	TA = -40°C~25°C
Offset error ^[2]	V _{OE}	-10		10	mV	TA = 25°C~125°C, I _{pr} =0A
		-10		10	mV	TA = -40°C~25°C, I _{pr} =0A
Reference error ^[2]	V _{RE}	-10		10	mV	TA = 25°C~125°C, I _{pr} =0A, V _{ref} -2.5V
		-15		15	mV	TA = -40°C~25°C, I _{pr} =0A, V _{ref} -2.5V
Total output error ^{[1][2]}	E _{total}	-2		2	%	TA = 25°C~125°C
		-2		2	%	TA = -40°C~25°C
Sensitivity error lifetime drift ^{[2][3]}	E _{sens_drift}	-2.5		2.5	%	After reliability test, TA = 25°C
Offset lifetime drift ^{[2][3]}	V _{OE_drift}	-15		15	mV	After reliability test, TA = 25°C
Reference Lifetime drift ^{[2][3]}	V _{RE_drift}	-15		15	mV	After reliability test, TA = 25°C
Total output error lifetime drift ^{[2][3]}	E _{total_drift}	-2.8		2.8	%	After reliability test, TA = 25°C

[1]: In production, total error and sensitivity error are measured and calculated at 30A, A single part will not have both the maximum/minimum sensitivity error and maximum/minimum offset voltage.

[2]: Min/Max value is the mean value +/-3sigma; according to the statistical law, 99.73% of the data is in this range Inside.

[3]: The reliability data is implemented in accordance with the AEC-Q100 standard. This item is derived from the experimental results with the largest change after the PC, HTS, HAST, UHAST, HTOL, TC and other test data required by AEC-Q100 Grade1 as a reference. , Is the worst case.

4.3. NSM2015-40B5F-Q1SWR Characteristics (TA= -40°C to 125°C, VCC = 5V, unless otherwise specified)

Parameters	Symbol	Min	Typ	Max	Unit	Comments
Current sensing range	I_{pr}	-40		40	A	
Sensitivity	Sens		50		mV/A	$I_{prmin} < I_{pr} < I_{prmax}$
Zero current output voltage	V_{QVO}		2.5		V	$I_{pr}=0A$
Sensitivity error ^{[1][2]}	E_{sens}	-2		2	%	TA = 25°C~125°C
		-2		2	%	TA = -40°C~25°C
Offset error ^[2]	V_{OE}	-10		10	mV	TA = 25°C~125°C, $I_{pr}=0A$
		-10		10	mV	TA = -40°C~25°C, $I_{pr}=0A$
Reference error ^[2]	V_{RE}	-10		10	mV	TA = 25°C~125°C, $I_{pr}=0A$, Vref-2.5V
		-15		15	mV	TA = -40°C~25°C, $I_{pr}=0A$, Vref-2.5V
Total output error ^{[1][2]}	E_{total}	-2		2	%	TA = 25°C~125°C
		-2		2	%	TA = -40°C~25°C
Sensitivity error lifetime drift ^{[2][3]}	E_{sens_drift}	-2.5		2.5	%	After reliability test, TA = 25°C
Offset lifetime drift ^{[2][3]}	V_{OE_drift}	-15		15	mV	After reliability test, TA = 25°C
Reference Lifetime drift ^{[2][3]}	V_{RE_drift}	-15		15	mV	After reliability test, TA = 25°C
Total output error lifetime drift ^{[2][3]}	E_{total_drift}	-2.8		2.8	%	After reliability test, TA = 25°C

[1]: In production, total error and sensitivity error are measured and calculated at 30A, A single part will not have both the maximum/minimum sensitivity error and maximum/minimum offset voltage.

[2]: Min/Max value is the mean value +/-3sigma; according to the statistical law, 99.73% of the data is in this range Inside.

[3]: The reliability data is implemented in accordance with the AEC-Q100 standard. This item is derived from the experimental results with the largest change after the PC, HTS, HAST, UHAST, HTOL, TC and other test data required by AEC-Q100 Grade1 as a reference. , Is the worst case.

4.4. NSM2015-66B5F-Q1SWR Characteristics (TA= -40°C to 125°C, VCC = 5V, unless otherwise specified)

Parameters	Symbol	Min	Typ	Max	Unit	Comments
Current sensing range	I_{pr}	-66		66	A	
Sensitivity	Sens		30.3		mV/A	$I_{prmin} < I_{pr} < I_{prmax}$
Zero current output voltage	V_{QVO}		2.5		V	$I_{pr}=0A$
Sensitivity error ^{[1][2]}	E_{sens}	-2		2	%	TA = 25°C~125°C

		-2		2	%	TA = -40°C~25°C
Offset error ^[2]	V _{OE}	-10		10	mV	TA = 25°C~125°C, I _{pr} =0A
		-10		10	mV	TA = -40°C~25°C, I _{pr} =0A
Reference error ^[2]	V _{RE}	-10		10	mV	TA = 25°C~125°C, I _{pr} =0A, V _{ref} -2.5V
		-15		15	mV	TA = -40°C~25°C, I _{pr} =0A, V _{ref} -2.5V
Total output error ^{[1] [2]}	E _{total}	-2		2	%	TA = 25°C~125°C
		-2		2	%	TA = -40°C~25°C
Sensitivity error lifetime drift ^{[2] [3]}	E _{sens_drift}	-2.5		2.5	%	After reliability test, TA = 25°C
Offset lifetime drift ^{[2] [3]}	V _{OE_drift}	-15		15	mV	After reliability test, TA = 25°C
Reference Lifetime drift ^{[2] [3]}	V _{RE_drift}	-15		15	mV	After reliability test, TA = 25°C
Total output error lifetime drift ^{[2] [3]}	E _{total_drift}	-2.8		2.8	%	After reliability test, TA = 25°C

[1]: In production, total error and sensitivity error are measured and calculated at 30A, A single part will not have both the maximum/minimum sensitivity error and maximum/minimum offset voltage.

[2]: Min/Max value is the mean value +/-3sigma; according to the statistical law, 99.73% of the data is in this range Inside.

[3]: The reliability data is implemented in accordance with the AEC-Q100 standard. This item is derived from the experimental results with the largest change after the PC, HTS, HAST, UHAST, HTOL, TC and other test data required by AEC-Q100 Grade1 as a reference. , Is the worst case.

4.5. NSM2015-20B5F-Q1SWR Characteristics (TA= -40°C to 125°C, VCC = 5V, unless otherwise specified)

Parameters	Symbol	Min	Typ	Max	Unit	Comments
Current sensing range	I _{pr}	-20		20	A	
Sensitivity	Sens		100		mV/A	I _{prmin} <I _{pr} <I _{prmax}
Zero current output voltage	V _{QVO}		2.5		V	I _{pr} =0A
Sensitivity error ^{[1][2]}	E _{sens}	-2		2	%	TA = 25°C~125°C
		-2		2	%	TA = -40°C~25°C
Offset error ^[2]	V _{OE}	-10		10	mV	TA = 25°C~125°C, I _{pr} =0A
		-10		10	mV	TA = -40°C~25°C, I _{pr} =0A
Reference error ^[2]	V _{RE}	-10		10	mV	TA = 25°C~125°C, I _{pr} =0A, V _{ref} -2.5V
		-15		15	mV	TA = -40°C~25°C, I _{pr} =0A, V _{ref} -2.5V
Total output error ^{[1] [2]}	E _{total}	-2		2	%	TA = 25°C~125°C
		-2		2	%	TA = -40°C~25°C
Sensitivity error lifetime drift ^{[2] [3]}	E _{sens_drift}	-2.5		2.5	%	After reliability test, TA = 25°C

Offset lifetime drift ^{[2] [3]}	V _{OE_drift}	-15		15	mV	After reliability test, TA = 25 °C
Reference Lifetime drift ^{[2] [3]}	V _{RE_drift}	-15		15	mV	After reliability test, TA = 25 °C
Total output error lifetime drift ^{[2] [3]}	E _{total_drift}	-2.8		2.8	%	After reliability test, TA = 25 °C

[1]: In production, total error and sensitivity error are measured and calculated at 20A, A single part will not have both the maximum/minimum sensitivity error and maximum/minimum offset voltage.

[2]: Min/Max value is the mean value +/-3sigma; according to the statistical law, 99.73% of the data is in this range Inside.

[3]: The reliability data is implemented in accordance with the AEC-Q100 standard. This item is derived from the experimental results with the largest change after the PC, HTS, HAST, UHAST, HTOL, TC and other test data required by AEC-Q100 Grade1 as a reference. , Is the worst case.

4.6. NSM2015-80B3F-Q1SWR Characteristics (TA= -40°C to 125°C, VCC = 3.3V, unless otherwise specified)

Parameters	Symbol	Min	Typ	Max	Unit	Comments
Current sensing range	I _{pr}	-80		80	A	
Sensitivity	Sens		16.5		mV/A	I _{prmin} <I _{pr} <I _{prmax}
Zero current output voltage	V _{QVO}		1.65		V	I _{pr} =0A
Sensitivity error ^{[1][2]}	E _{sens}	-2		2	%	TA = 25 °C~125 °C
		-2		2	%	TA = -40 °C~25 °C
Offset error ^[2]	V _{OE}	-10		10	mV	TA = 25 °C~125 °C, I _{pr} =0A
		-10		10	mV	TA = -40 °C~25 °C, I _{pr} =0A
Reference error ^[2]	V _{RE}	-10		10	mV	TA = 25 °C~125 °C, I _{pr} =0A, Vref-1.65V
		-15		15	mV	TA = -40 °C~25 °C, I _{pr} =0A, Vref-1.65V
Total output error ^{[1] [2]}	E _{total}	-2		2	%	TA = 25 °C~125 °C
		-2		2	%	TA = -40 °C~25 °C
Sensitivity error lifetime drift ^{[2] [3]}	E _{sens_drift}	-2.5		2.5	%	After reliability test, TA = 25 °C
Offset lifetime drift ^{[2] [3]}	V _{OE_drift}	-15		15	mV	After reliability test, TA = 25 °C
Reference Lifetime drift ^{[2] [3]}	V _{RE_drift}	-15		15	mV	After reliability test, TA = 25 °C
Total output error lifetime drift ^{[2] [3]}	E _{total_drift}	-2.8		2.8	%	After reliability test, TA = 25 °C

[1]: In production, total error and sensitivity error are measured and calculated at 30A, A single part will not have both the maximum/minimum sensitivity error and maximum/minimum offset voltage.

[2]: Min/Max value is the mean value +/-3sigma; according to the statistical law, 99.73% of the data is in this range Inside.

[3]: The reliability data is implemented in accordance with the AEC-Q100 standard. This item is derived from the experimental results with the largest change after the PC, HTS, HAST, UHAST, HTOL, TC and other test data required by AEC-Q100 Grade1 as a reference. , Is the worst case.

4.7. NSM2015-40B3F-Q1SWR Characteristics (TA= -40°C to 125°C, VCC = 3.3V, unless otherwise specified)

Parameters	Symbol	Min	Typ	Max	Unit	Comments
Current sensing range	I_{pr}	-40		40	A	
Sensitivity	Sens		33		mV/A	$I_{prmin} < I_{pr} < I_{prmax}$
Zero current output voltage	V_{QVO}		1.65		V	$I_{pr}=0A$
Sensitivity error ^{[1][2]}	E_{sens}	-2		2	%	TA = 25°C~125°C
		-2		2	%	TA = -40°C~25°C
Offset error ^[2]	V_{OE}	-10		10	mV	TA = 25°C~125°C, $I_{pr}=0A$
		-10		10	mV	TA = -40°C~25°C, $I_{pr}=0A$
Reference error ^[2]	V_{RE}	-10		10	mV	TA = 25°C~125°C, $I_{pr}=0A$, Vref-1.65V
		-15		15	mV	TA = -40°C~25°C, $I_{pr}=0A$, Vref-1.65V
Total output error ^{[1][2]}	E_{total}	-2		2	%	TA = 25°C~125°C
		-2		2	%	TA = -40°C~25°C
Sensitivity error lifetime drift ^{[2][3]}	E_{sens_drift}	-2.5		2.5	%	After reliability test, TA = 25°C
Offset lifetime drift ^{[2][3]}	V_{OE_drift}	-15		15	mV	After reliability test, TA = 25°C
Reference Lifetime drift ^{[2][3]}	V_{RE_drift}	-15		15	mV	After reliability test, TA = 25°C
Total output error lifetime drift ^{[2][3]}	E_{total_drift}	-2.8		2.8	%	After reliability test, TA = 25°C

[1]: In production, total error and sensitivity error are measured and calculated at 30A, A single part will not have both the maximum/minimum sensitivity error and maximum/minimum offset voltage.

[2]: Min/Max value is the mean value +/-3sigma; according to the statistical law, 99.73% of the data is in this range inside.

[3]: The reliability data is implemented in accordance with the AEC-Q100 standard. This item is derived from the experimental results with the largest change after the PC, HTS, HAST, UHAST, HTOL, TC and other test data required by AEC-Q100 Grade1 as a reference. , Is the worst case.

4.8. NSM2015-66B3F-Q1SWR Characteristics (TA= -40°C to 125°C, VCC = 3.3V, unless otherwise specified)

Parameters	Symbol	Min	Typ	Max	Unit	Comments
Current sensing range	I_{pr}	-66		66	A	
Sensitivity	Sens		20		mV/A	$I_{prmin} < I_{pr} < I_{prmax}$
Zero current output voltage	V_{QVO}		1.65		V	$I_{pr}=0A$
Sensitivity error ^{[1][2]}	E_{sens}	-2		2	%	TA = 25°C~125°C
		-2		2	%	TA = -40°C~25°C
Offset error ^[2]	V_{OE}	-10		10	mV	TA = 25°C~125°C, $I_{pr}=0A$
		-10		10	mV	TA = -40°C~25°C, $I_{pr}=0A$

Reference error ^[2]	V _{RE}	-10		10	mV	TA = 25°C~125°C, I _{pr} =0A, V _{ref} -1.65V
		-15		15	mV	TA = -40°C~25°C, I _{pr} =0A, V _{ref} -1.65V
Total output error ^{[1] [2]}	E _{total}	-2		2	%	TA = 25°C~125°C
		-2		2	%	TA = -40°C~25°C
Sensitivity error lifetime drift ^{[2] [3]}	E _{sens_drift}	-2.5		2.5	%	After reliability test, TA = 25°C
Offset lifetime drift ^{[2] [3]}	V _{OE_drift}	-15		15	mV	After reliability test, TA = 25°C
Reference Lifetime drift ^{[2] [3]}	V _{RE_drift}	-15		15	mV	After reliability test, TA = 25°C
Total output error lifetime drift ^{[2] [3]}	E _{total_drift}	-2.8		2.8	%	After reliability test, TA = 25°C

[1]: In production, total error and sensitivity error are measured and calculated at 30A, A single part will not have both the maximum/minimum sensitivity error and maximum/minimum offset voltage.

[2]: Min/Max value is the mean value +/-3sigma; according to the statistical law, 99.73% of the data is in this range Inside.

[3]: The reliability data is implemented in accordance with the AEC-Q100 standard. This item is derived from the experimental results with the largest change after the PC, HTS, HAST, UHAST, HTOL, TC and other test data required by AEC-Q100 Grade1 as a reference. , Is the worst case.

4.9. NSM2015-100B5F-Q1SWR Characteristics (TA= -40°C to 125°C, VCC = 5V, unless otherwise specified)

Parameters	Symbol	Min	Typ	Max	Unit	Comments
Current sensing range	I _{pr}	-100		100	A	
Sensitivity	Sens		20		mV/A	I _{prmin} <I _{pr} <I _{prmax}
Zero current output voltage	V _{QVO}		2.5		V	I _{pr} =0A
Sensitivity error ^{[1][2]}	E _{sens}	-2		2	%	TA = 25°C~125°C
		-2		2	%	TA = -40°C~25°C
Offset error ^[2]	V _{OE}	-10		10	mV	TA = 25°C~125°C, I _{pr} =0A
		-10		10	mV	TA = -40°C~25°C, I _{pr} =0A
Reference error ^[2]	V _{RE}	-10		10	mV	TA = 25°C~125°C, I _{pr} =0A, V _{ref} -2.5V
		-15		15	mV	TA = -40°C~25°C, I _{pr} =0A, V _{ref} -2.5V
Total output error ^{[1] [2]}	E _{total}	-2		2	%	TA = 25°C~125°C
		-2		2	%	TA = -40°C~25°C
Sensitivity error lifetime drift ^{[2] [3]}	E _{sens_drift}	-2.5		2.5	%	After reliability test, TA = 25°C
Offset lifetime drift ^{[2] [3]}	V _{OE_drift}	-15		15	mV	After reliability test, TA = 25°C
Reference Lifetime drift ^{[2] [3]}	V _{RE_drift}	-15		15	mV	After reliability test, TA = 25°C
Total output error lifetime drift ^{[2] [3]}	E _{total_drift}	-2.8		2.8	%	After reliability test, TA = 25°C

[1]: In production, total error and sensitivity error are measured and calculated at 30A, A single part will not have both the maximum/minimum sensitivity error and maximum/minimum offset voltage.

[2]: Min/Max value is the mean value +/-3sigma; according to the statistical law, 99.73% of the data is in this range Inside.

[3]: The reliability data is implemented in accordance with the AEC-Q100 standard. This item is derived from the experimental results with the largest change after the PC, HTS, HAST, UHAST, HTOL, TC and other test data required by AEC-Q100 Grade1 as a reference. , Is the worst case.

In the fourth chapter, the increase or decrease of the material number and the tightening of the parameter range, Novosense reserves the right not to send PCN to the customer, unless the expansion of the parameter range affects the customer's use and product performance.

5. Function Description

5.1. Overview

NSM2015 current sensor can accurately measure AC/DC current while minimizing the overall measurement cost. Current sensors based on the Hall principle can be widely used in all current monitoring applications such as consumption, industry, and automotive. Compared with current transformers, the extremely small size of NSM2015 SOIC16W can help customers reduce the overall PCB area; compared to Shunt+isolated op amps, NSM2015 only needs low-voltage side power supply, reducing the inconvenience of isolated op amps requiring power supply for both high and low voltages. When using NSM2015, you only need to string the primary side pin into the measured current. According to the part of Maxwell equations about electricity and magnetism, a magnetic field will be generated around the energized conductor of the primary side. The Hall and conditioning amplifier circuits in NSM2015 will convert magnetic field into an output voltage, and the output voltage increases or decreases in proportion to the input current.

Benefiting from the typical value of the primary resistance of NSM2015 is only 0.85mohm, as long as the customer conducts a reasonable heat dissipation design, the temperature rise brought by the measurement of large current can be effectively reduced.

At the same time, NSM2015 uses dual Hall sampling internally, the common mode magnetic field brought by the outside world can be effectively reduced. According to the measured typical value, if the 100G common mode magnetic field acts vertically on the chip, it will only bring an error of less than 1G in the output. (Equivalent to input). Because NSM2015 has a good ability to resist common-mode magnetic fields, it can still maintain excellent performance in motor control or some harsh current measurement environments.

5.2. NSM2015 F version(fixed output)

In some applications, the ADC and the current sensor do not share a power rail, so the sensor needs to have absolute sensitivity that does not vary with the power supply voltage. The value of the sensing current can be obtained by $(v_{out}-v_{ref})/Sensitivity$. For $\pm 50A$ measurement range, if V_{out} measures 3.7V and V_{REF} measures 2.5V, then the input current is $(3.7V-2.5V)/40mV/A=30A$. In practical applications, V_{out} and V_{REF} can be directly collected by differential ADC to obtain input current, and the measurement accuracy will not be affected by power supply changes.

5.3. Overcurrent Fault Performance

NSM2015 has overcurrent protect function. When the primary current exceeds the overcurrent threshold, the internal error comparator reverses, driving Open Drain Output to work, and the Fault pin is pulled down. The overcurrent threshold can be set by using V_{oc} voltage through the external resistance on the V_{oc} pin. This voltage can be set from the V_{ref} source. The effective input voltage of V_{oc} is between 0.33V and 2V. The corresponding relationship between the overcurrent threshold and V_{oc} voltage is shown in the following table.

$V_{oc} (V_{cc}=3.3V) (V)$	$V_{oc} (V_{cc}=5V) (V)$	Bipolar version	Unipolar version
0.33~0.495	0.5~0.75	75%	75%
0.495~0.661	0.75~1	100%	100%
0.661~0.826	1~1.25	125%	125%
0.826~0.991	1.25~1.5	150%	150%
0.991~1.156	1.5~1.75	175%	175%
1.156~1.32	1.75~2	200%	200%

Overcurrent Fault is triggered when the primary current (positive or negative current) exceeds the overcurrent threshold set. Fault is cleared when the absolute value of the primary current is less than the current threshold set minus current hysteresis. T_{fr} is Fault Response time: the time from the primary current meets the overcurrent condition to Fault pin is pulled down. The timing of overcurrent protection is as follows:

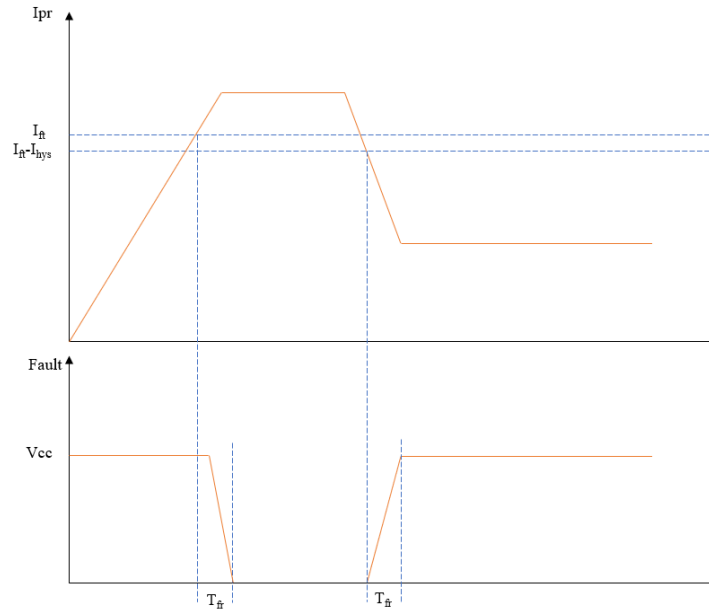

Figure 5.1 NSM2015 Overcurrent Performance

5.4. NSM2015 Power-on time wave

Yellow: VCC 、 Green: VOUT 、 Blue: VREF 、 Red: Fault, The output is not stable because OTP loading is not finished. The maximum OTP loading time is 1ms. Recommend customer to read output after 1ms power-on time.



(a) VOUT detail

(b) VREF detail

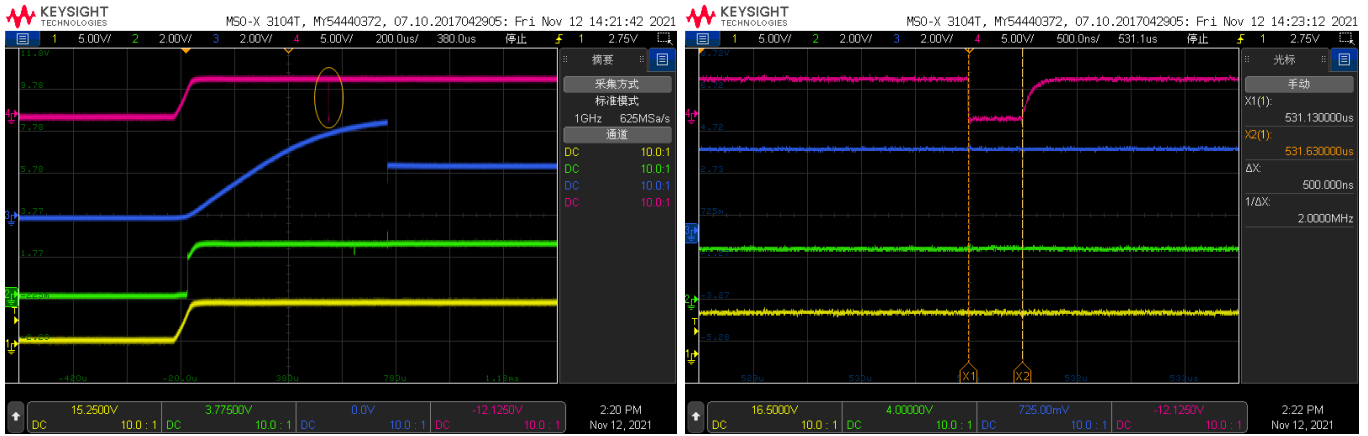

(c) Fault detail

Figure 5.2 NSM2015 Power-on time wave

If the customer wants the waveform of VOUT and VREF follow the VCC waveform during power-on time, a 10kΩ resistance can be connected between VOUT pin and VREF pin.

Yellow: VCC 、 Green: VOUT 、 Blue: VREF 、 Red: Fault



(a) VOUT detail

(b) VREF detail

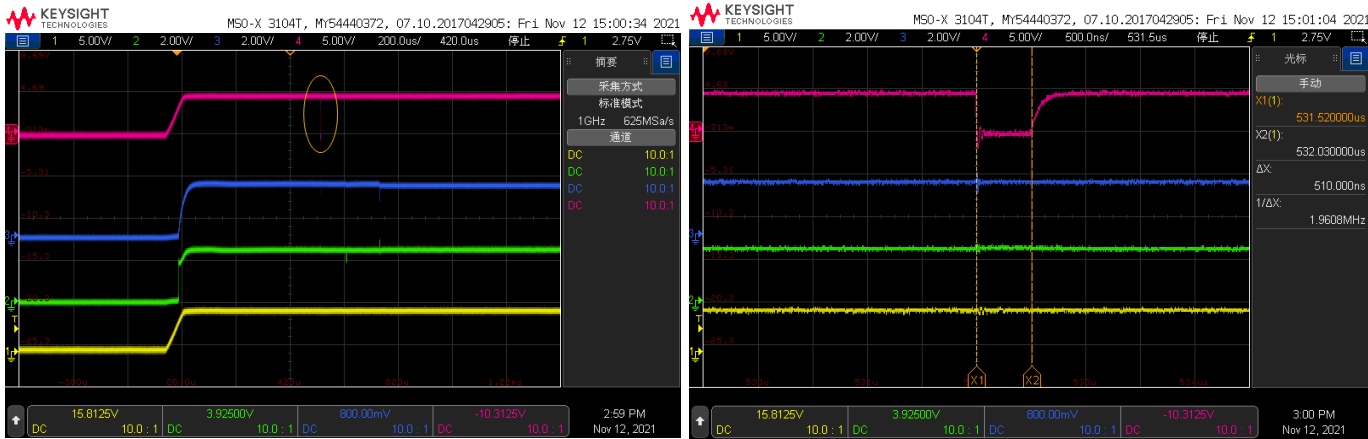

(c) Fault detail

Figure 5.3 NSM2015 Power-on time wave (10kΩ Resistance connected between VOUT and VREF)

Note: The above waveform DUT is NSM2015-50B5F-Q1SWR

5.5. NSM2015 Rise time and Response time wave

(1) Rise time

Yellow: primary current、Green: VOUT

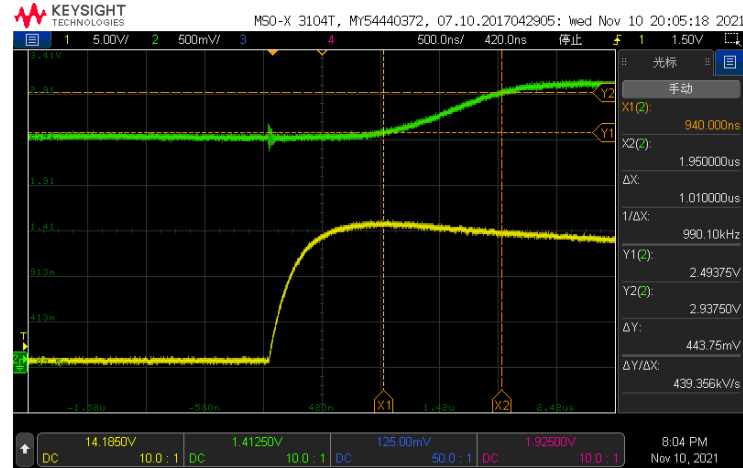

(2) Response time

Yellow: primary current、Green: VOUT

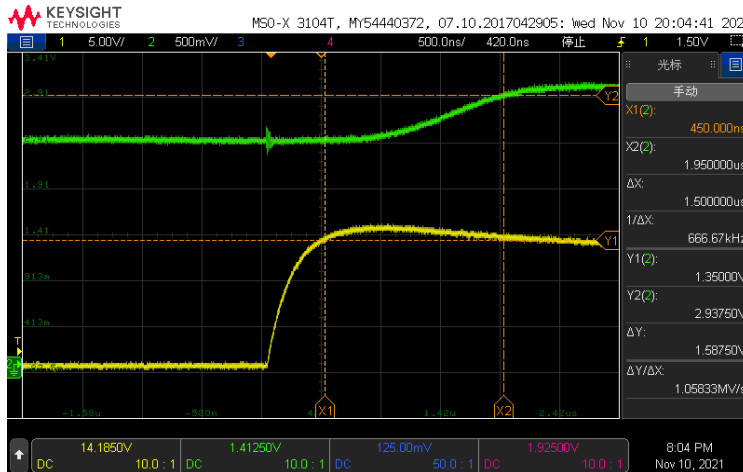

(3) Propagation Delay time

Yellow: primary current、Green: VOUT

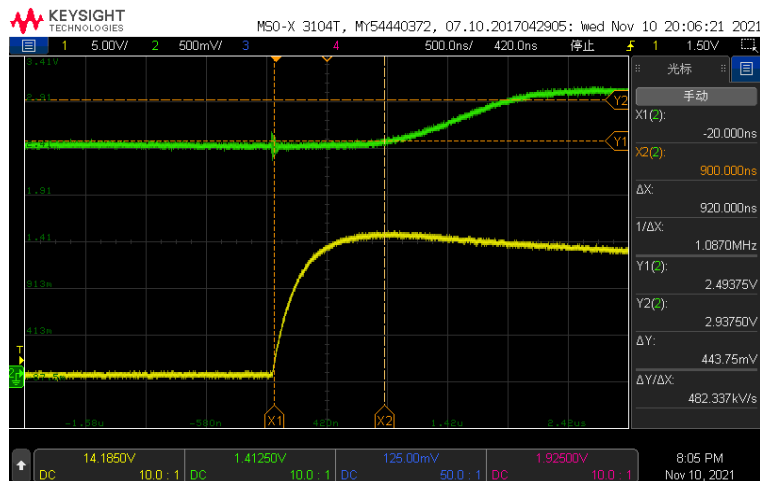

Note: The above waveform DUT is NSM2015-50B5F-Q1SWR

(4) Fault Response time Yellow: primary current、Green: VOUT

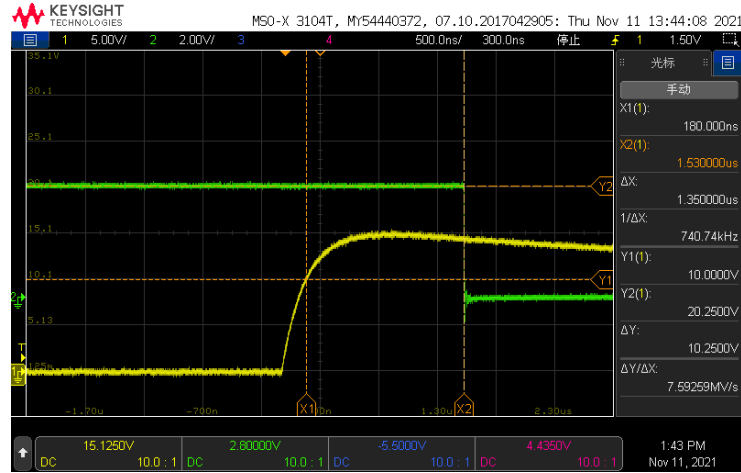

Note: The above waveform DUT is NSM2015-20B5F-Q1SWR

5.6. NSM2015 Bandwidth Test

100Hz-350KHz input signal, -3dB Bandwidth : 320kHz.

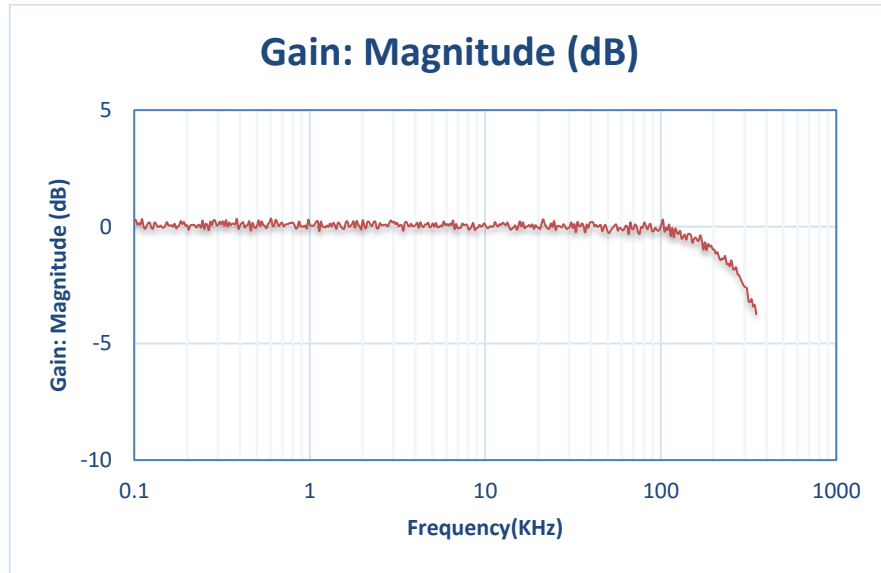

Figure 5.4 NSM2015 Amplitude frequency response curve

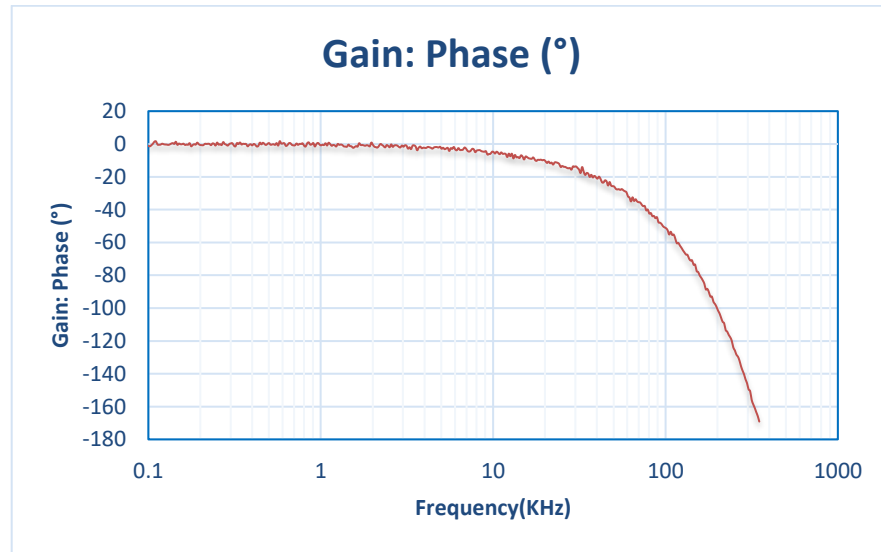

Figure 5.5 NSM2015 Phase frequency response curve

Note: The above waveform DUT is NSM2015-50B5F-Q1SWR

5.7. Definition of NSM2015 terms

Power-on time (T_{po})

When the power supply climbs from 0 to the chip's working range, NSM2015 needs some time to establish the internal working logic. T_{po} time is defined as: the time from the power supply climbing to V_{ccmin} to the output reaching the steady state within $\pm 10\%$, As shown below:

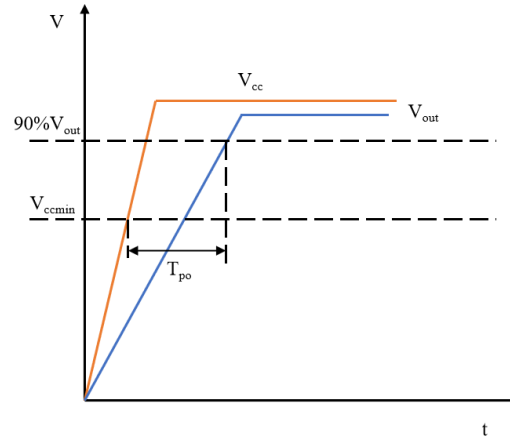

Figure 5.6 NSM2015 Power-on time

Rise time (T_r)

The time from 10% to 90% of the output signal is defined as the output rise time. For step input signals, there is such an approximate relationship between the rise time and bandwidth of the output signal: $f(-3dB) = 0.35/T_r$.

Propagation delay (T_{pd})

The time from 20% of the primary current to 20% of the output signal is defined as the output propagation delay time.

Response time ($T_{response}$)

The time from 90% of the primary current to 90% of the output signal is defined as the output response time.

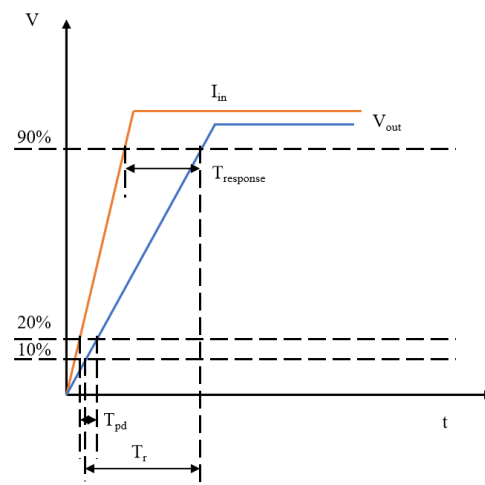

Figure 5.7 NSM2015 response time

Sensitivity and sensitivity error

Sensitivity is defined as the ratio of the output voltage proportional to the primary input current. Sensitivity is the slope of the curve in the figure below.

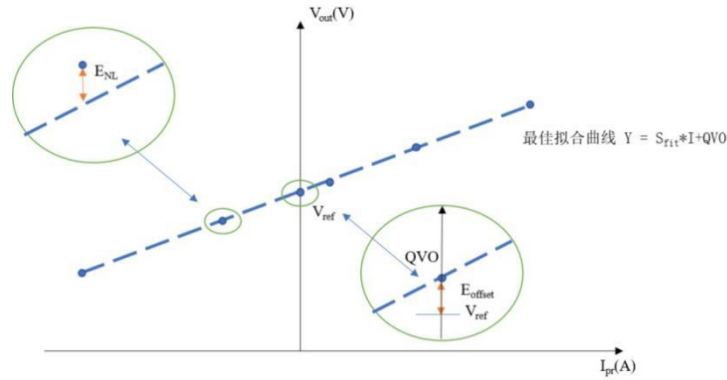

Figure 5.8 NSM2015 Sensitivity and error

The sensitivity error is defined as the deviation between the slope of the best-fit curve and the slope of the ideal curve. The slope of the best-fit curve comes from the measured value:

$$E_{sens} = \frac{(S_{fit} - S_{ideal})}{S_{ideal}} * 100\%$$

Offset error

The zero current output error is defined as the difference between the output voltage and the reference voltage when the primary current is 0A, V_{ref} here is $VCC/2$ or $0.1 * VCC$ (R version):

$$E_{offset} = QVO - V_{ref}$$

Nonlinear error

The linearity error is defined as the error from the maximum deviation point of the best-fit curve to the full scale. The mathematical expression is as follows:

$$V_{NL} = V_{outmax} - (S_{fit} * I_{max} + QVO)$$

among them:

V_{outmax} is the output voltage furthest from the fitted curve;

I_{max} is the primary current farthest from the fitted curve;

Therefore, the nonlinear error can be mathematically expressed as the following formula:

$$E_{NL} = \frac{V_{NL}}{FS} * 100\%$$

Total error

The total error is defined as the error between the actual given current and the current measured by the chip, in other words, the difference between the actual output voltage and the ideal output voltage. It should be known that in different current ranges, the factors that dominate the total error are different. If it is under low current measurement, the zero point error is the main source of error; if under high current measurement, the total error caused by the zero point error is very small, and the dominant error is the sensitivity error.

$$E_{total}(I_{pr}) = \frac{V_{outideal}(I_{pr}) - V_{out}(I_{pr})}{FS}$$

6. Application note

6.1. Typical application circuit

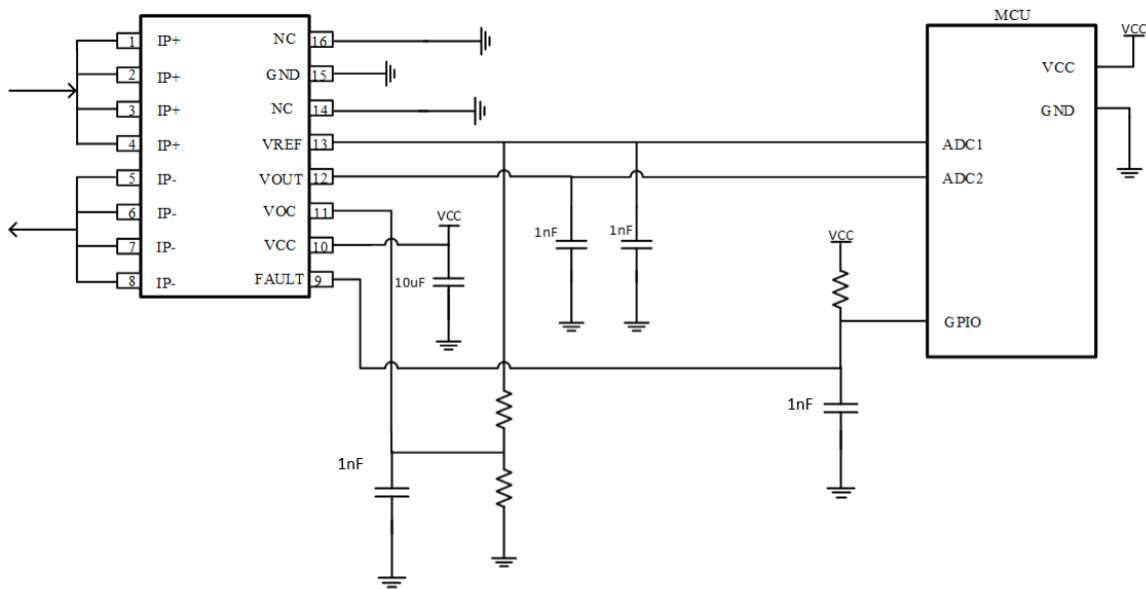

Figure 6.1 Typical application diagram of Fixed output mode

6.2. PCB Layout

For NSM2015 in high-current monitoring applications, a reasonable layout will make the system heat dissipation faster and better. The copper area on the NSM2015 Demo board is 21mm*18mm (very small copper area is used to illustrate the worse situation, rather than a large copper area), the top layer and the bottom layer are 2oz copper thick. Under this layout, after 30 minutes, after the 35A current stabilizes, the surface temperature of the chip is as shown in the lower right picture. The highest point temperature is around 70°C. Foreign competitors can reach 90°C under the same layout. . The reason why NSM2015 is better than competitors for heat dissipation is due to the use of packaging materials with better heat dissipation coefficients and a copper frame with better heat dissipation coefficients. If customers want to achieve better heat dissipation, they can use multi-layer boards and thicken the copper thickness to achieve it, and can use active heat dissipation solutions in the system, such as adding heat sinks and fans. If you need to use the NSM2015 Demo board to evaluate the performance of this current sensor, please contact Novosense sales team for support.

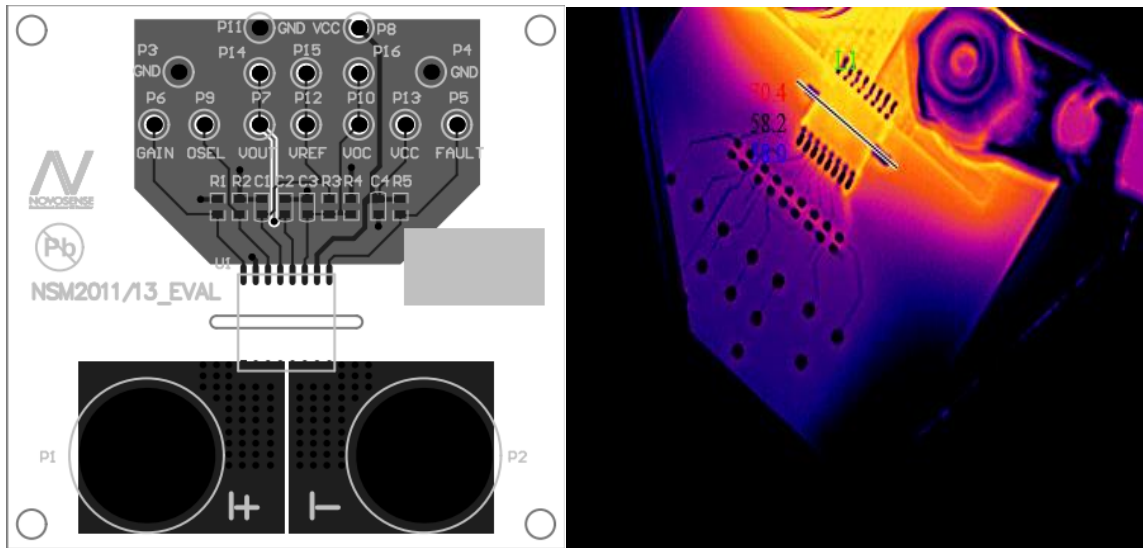

Figure 6.2 NSM2015 PCB Layout

6.3. Thermal evaluation

The thermal evaluation experiment is tested at room temperature, which mainly illustrates the temperature rise of the NSM2015 current sensor under different currents. With these data and the above-mentioned layout guide, customers can design heat dissipation according to actual application requirements. The ambient temperature in this experiment is room temperature. The surface is mounted on the above Demo board for temperature rise test. There is no external active heat dissipation device (such as a fan, etc.). The relationship between junction temperature and time is measured. 20 minutes of temperature data are collected. Under normal circumstances, the temperature rise It is basically fixed in about 10 minutes, and the specific test data are as follows:

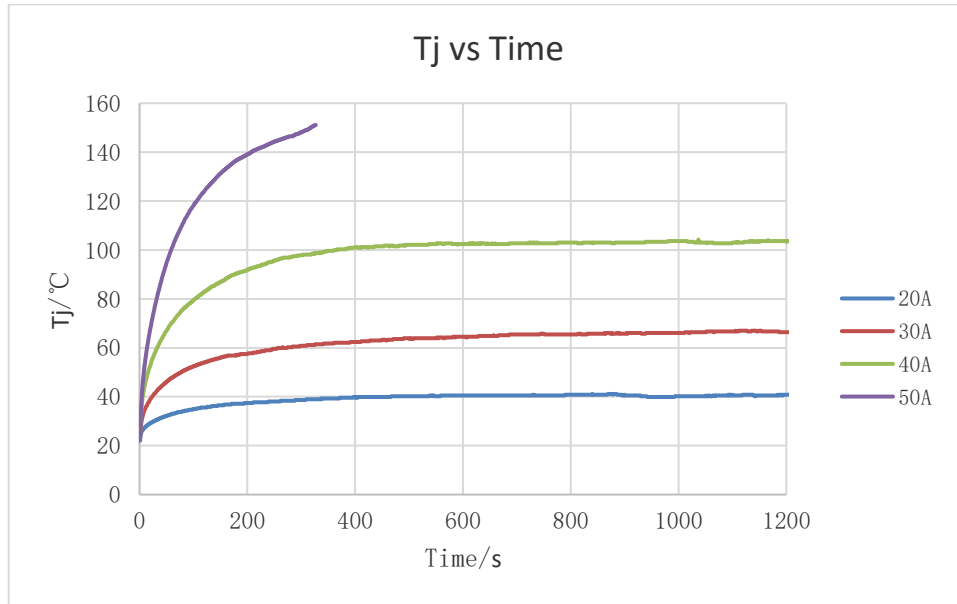

Figure 6.3 NSM2015 Junction temperature vs. Different continues current

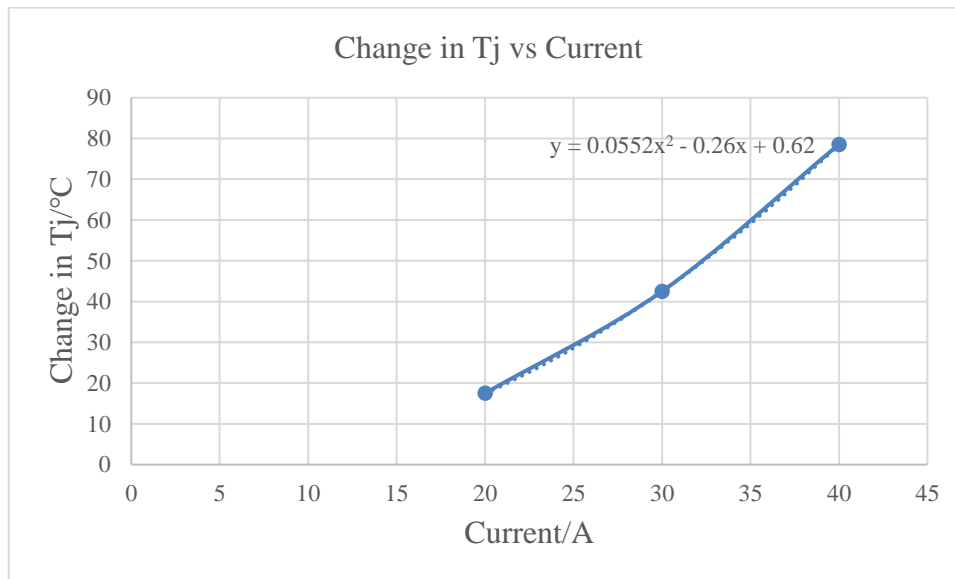

Figure 6.4 NSM2015 Estimation function of junciton temperature at different currents (PCB is in worst case)

It is important to note that the above temperature rise experiment data is only based on the Demo board, in order to reflect the relationship between NSM2015 current and temperature in a worst case. Customers can reduce the temperature rise of Tj by increasing or thickening the copper area of the PCB, using multi-layer boards, or adding active heat dissipation devices such as fans (Tj<150°C). If customers compare NSM2015 with other competing products, please refer to the same PCB design instead of using specially designed PCB provided by competing products. Novosense can provide a 16-pin general-purpose Demo board for comparison of temperature rises of competing products.

7. Package Information

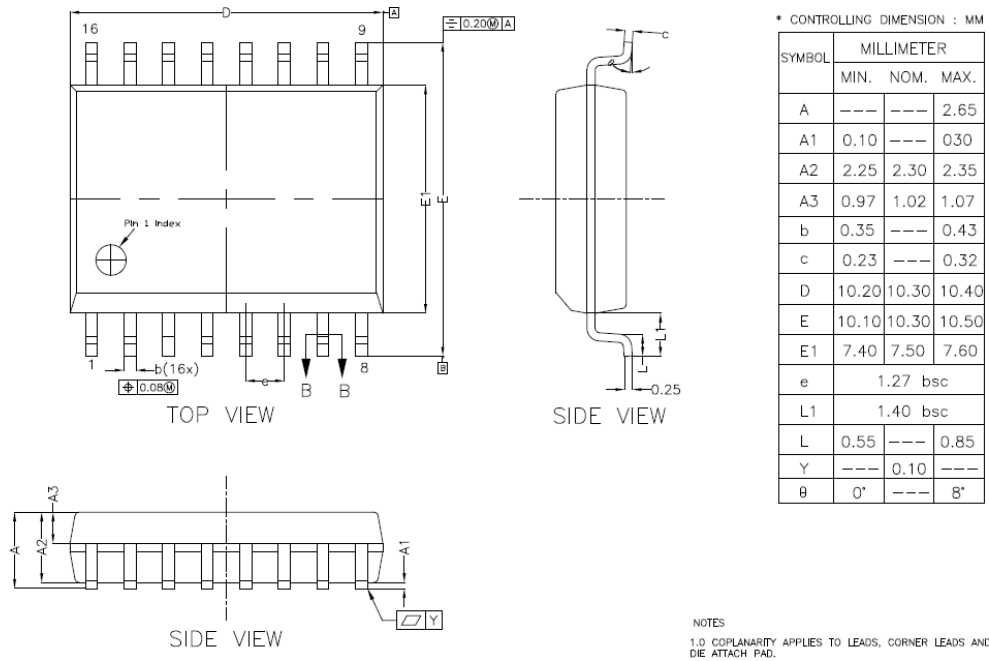

Figure 7.1 SOW16 Package Shape and Dimension in millimeters and (inches)

8. Order Information

Order information:

Part number	Primary current(A)	Power supply(V)	Sensitivity(mV/A)	Package
NSM2015-50B5F-Q1SWR	±50	5V	40	SOW16
NSM2015-40B5F-Q1SWR	±40	5V	50	SOW16
NSM2015-66B5F-Q1SWR	±66	5V	30.3	SOW16
NSM2015-20B5F-Q1SWR	±20	5V	100	SOW16
NSM2015-80B3F-Q1SWR	±80	3.3V	16.5	SOW16
NSM2015-40B3F-Q1SWR	±40	3.3V	33	SOW16
NSM2015-66B3F-Q1SWR	±66	3.3V	20	SOW16
NSM2015-100B5F-Q1SWR	±100	5V	20	SOW16

Other ordering material numbers are acceptable: *If you need other current ranges or 3.3V power supply version, please contact Novosense for special support

Naming rules:

NSM2015-50B5F-DSWR



D: Industry, Q: Automotive
 R: Ratiometric, F: fixed
 5: 5V power supply, 3: 3.3V power supply
 B: Bipolar, U: Unipolar
 50: Current range
 Have 10A/20A/30A/40A/50A/65A current range, there standard order is 20A, 30A, 50A version

9. TAPE AND REEL INFORMATION

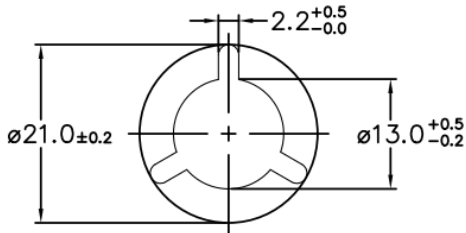
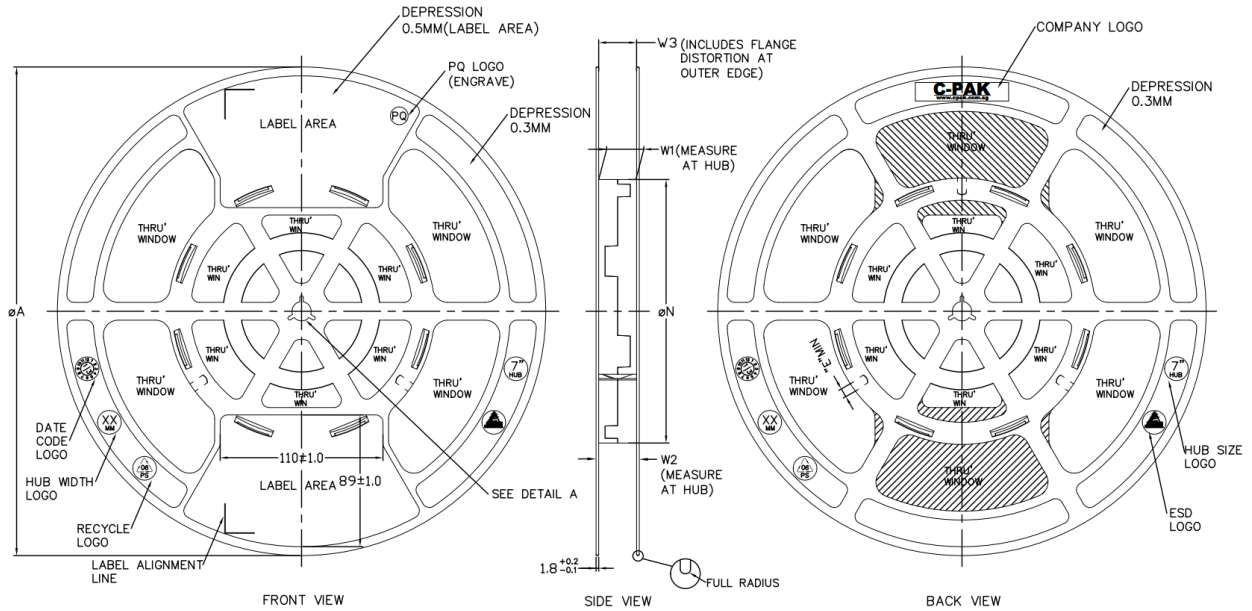

ARBOR HOLE
DETAIL A
SCALE : 3:1

PRODUCT SPECIFICATION						
TAPE WIDTH	ϕA ± 2.0	ϕN ± 2.0	W1	W2 (MAX)	W3	E (MIN)
08MM	330	178	$8.4^{+1.5}_{-0.0}$	14.4	SHALL ACCOMMODATE TAPE WIDTH WITHOUT INTERFERENCE	5.5
12MM	330	178	$12.4^{+2.0}_{-0.0}$	18.4		5.5
16MM	330	178	$16.4^{+2.0}_{-0.0}$	22.4		5.5
24MM	330	178	$24.4^{+2.0}_{-0.0}$	30.4		5.5
32MM	330	178	$32.4^{+2.0}_{-0.0}$	38.4		5.5

SURFACE RESISTIVITY			
LEGEND	SR RANGE	TYPE	COLOUR
A	BELOW 10^{12}	ANTISTATIC	ALL TYPES
B	10^9 TO 10^{11}	STATIC DISSIPATIVE	BLACK ONLY
C	10^5 & BELOW 10^8	CONDUCTIVE (GENERIC)	BLACK ONLY
E	10^9 TO 10^{11}	ANTISTATIC (COATED)	ALL TYPES

Note: MPQ(SOW16):1K

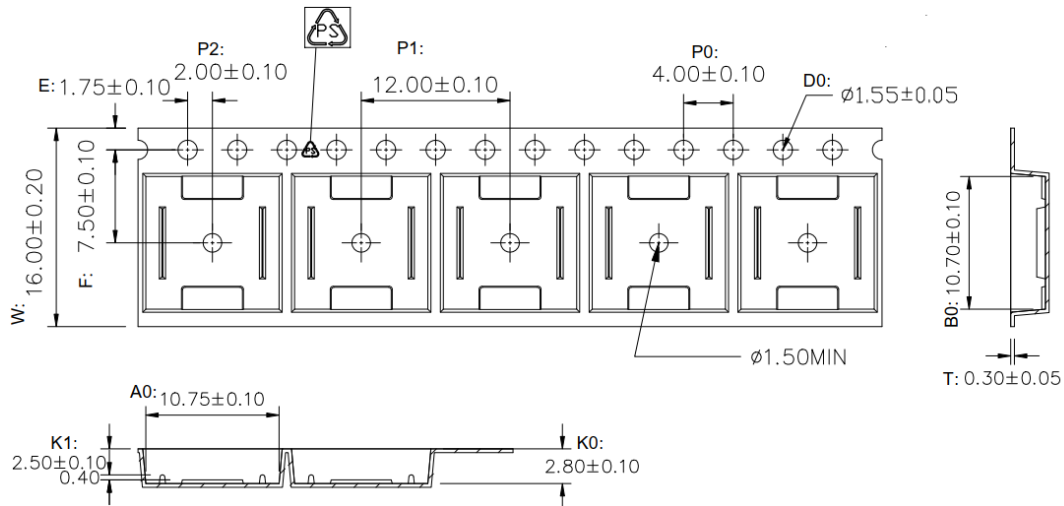

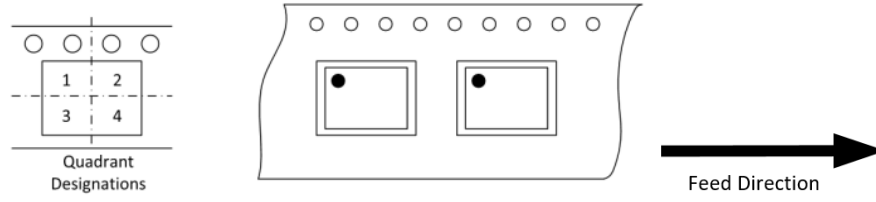

Figure 9.1 Tape and Reel Information of SOW16

10. Revision History

Revision	Description	Date
1.0	Released Version.	2022/5/17