

REVISED RECORD				
REV NO.	CONTENT	CHG BY	DATE	APPROVED BY
A0.		Gavin	2014/01/11	

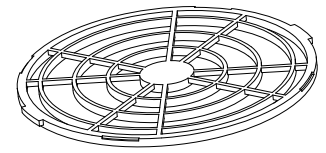

Guard

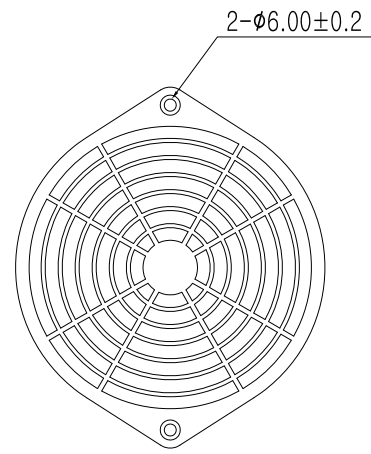
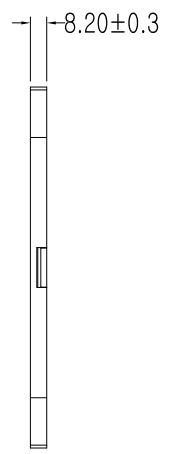
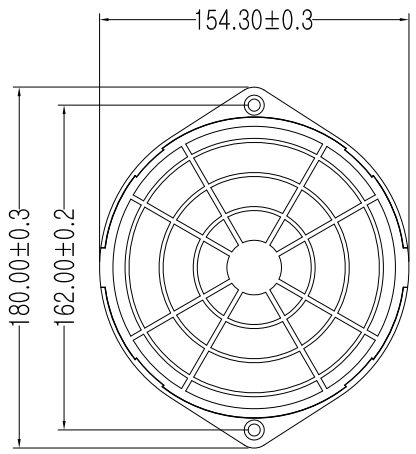
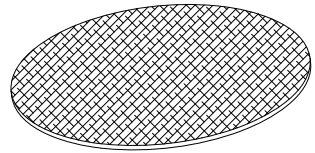

Filter

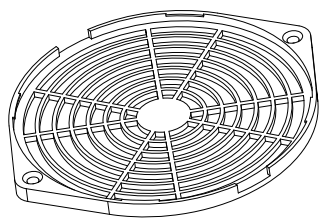
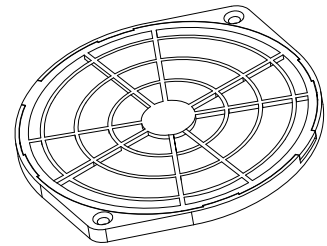

Retainer

Fits for Fan Size:
172*150*38mm 172*150*55mm

- Specifications:
- *Retainer & Guard Material: Flame Retardant plastic ABS thermoplastic, rated UL94V-0.
 - *Retainer & Guard Color: Standard black.
 - *Filter material: Polyurethane (PU) Foam; Size: ∅150*3.0mm
 - *Filter Density: 40PPI, 60PPI (pores per inch).
 - *No Burr, Flash, Bruising, Scratches.
 - *Product not deformation.

Product dimension Gen. Tol. : ±0.05		Control Dimensions		x.xxx		For QC Check	
DWG REV	UNLESS OTHERWISE SPECIFIED TOLERANCES		COOLTRON INDUSTRIAL SUPPLY, INC.				
	DATE	X.XXXFL ± 0.127 X.XX ± 0.254 X.X ± 0.5	UNITS	COOLTRON®			
	2014/01/11		MM				
A0	DRAWN	Gavin	DATE	2014/01/11	TITLE:	PLASTIC FAN FILTER	
A1	CHECKED		DATE		Drawing Number:	FPF-162A-40	
A2	APPROVED		DATE		Process:	SCALE	1:1
A3	THIRD ANGLE		PROJECT		SHT OF A total of one page The first page		