

TFT DISPLAY SPECIFICATION



WINSTAR Display Co.,Ltd.
華凌光電股份有限公司



Winstar Display Co., LTD

華凌光電股份有限公司



WEB: <https://www.winstar.com.tw> E-mail: sales@winstar.com.tw

SPECIFICATION

CUSTOMER : _____

MODULE NO.: **WF50DSYA3MNNO#**

APPROVED BY: (FOR CUSTOMER USE ONLY)	PCB VERSION:	DATA:
--	---------------------	--------------

SALES BY	APPROVED BY	CHECKED BY	PREPARED BY
			葉虹蘭
ISSUED DATE: 2020/07/28			

TFT Display Inspection Specification: <https://www.winstar.com.tw/technology/download.html>

Precaution in use of TFT module: <https://www.winstar.com.tw/technology/download/declaration.html>

RECORDS OF REVISION

DOC. FIRST ISSUE

VERSION	DATE	REVISED PAGE NO.	SUMMARY
0	2019/02/18		First issue
A	2020/03/27		TFT Interface: 4-Lanes MIPI
B	2020/07/28		Modify Backlight Driving Conditions

Contents

1. Module Classification Information
2. Summary
3. General Specification
4. Absolute Maximum Ratings
5. Electrical Characteristics
6. DC Characteristics
7. AC Characteristics
8. Waveform
9. Optical Characteristics
10. Interface
11. Reliability
12. Contour Drawing
13. Other

1.Module Classification Information

W F 50 D S Y A 3 M N N 0 #
 ① ② ③ ④ ⑤ ⑥ ⑦ ⑧ ⑨ ⑩ ⑪ ⑫ ⑬

①	Brand : WINSTAR DISPLAY CORPORATION											
②	Display Type : F→TFT Type, J→Custom TFT											
③	Display Size : 5.0" TFT											
④	Model serials no.											
⑤	Backlight Type :	F→CCFL, White S→LED, High Light White					T→LED, White Z→Nichia LED, White					
⑥	LCD Polarize Type/ Temperature range/ Gray Scale Inversion Direction	A→Transmissive, N.T, IPS TFT C→Transmissive, N. T, 6:00 ; F→Transmissive, N.T,12:00 ; I→Transmissive, W. T, 6:00 K→Transflective, W.T,12:00 L→Transmissive, W.T,12:00 N→Transmissive, Super W.T, 6:00					Q→Transmissive, Super W.T, 12:00 R→Transmissive, Super W.T, O-TFT V→Transmissive, Super W.T, VA TFT W→Transmissive, Super W.T, IPS TFT X→Transmissive, W.T, VA TFT Y→Transmissive, W.T, IPS TFT Z→Transmissive, W.T, O-TFT					
⑦	A : TFT LCD B : TFT+SCREW HOLES+CONTROL BOARD C : TFT+ SCREW HOLES +A/D BOARD D : TFT+ SCREW HOLES +A/D BOARD+CONTROL BOARD E : TFT+ SCREW HOLES +POWER BOARD					F : TFT+CONTROL BOARD G : TFT+ SCREW HOLES H : TFT+D/V BOARD I : TFT+ SCREW HOLES +D/V BOARD J : TFT+POWER BD						
⑧	Resolution:											
	A	128160	B	320234	C	320240	D	480234	E	480272	F	640480
	G	800480	H	1024600	I	320480	J	240320	K	800600	L	240400
	M	1024768	N	128128	P	1280800	Q	480800	R	640320	S	480128
	T	800320	U	8001280	V	176220	W	1280398	X	1024250	Y	1920720
	Z	800200	2	1024324	3	7201280	4	19201200	5	1366768	6	1280320
⑨	D: Digital L : LVDS M:MIPI											
⑩	Interface:											
	N	Without control board			A	8Bit		B	16Bit		H	HDMI
	I	I2C Interface			R	RS232		S	SPI Interface		U	USB
⑪	TS:											
	N	Without TS			T	Resistive touch panel			C	Capacitive touch panel (G-F-F)		
	G	Capacitive touch panel (G-G)					C1	Capacitive touch panel (G-F-F)+OCA				
	C2	Capacitive touch panel (G-F-F)+OCR					G1	Capacitive touch panel (G-G)+OCA				
	G2	Capacitive touch panel (G-G)+OCR					B	CTP+GG+USB				
⑫	Version: X:Raspberry pi											
⑬	Special Code	#:Fit in with ROHS directive regulations										

--	--	--

WINSTAR DISPLAY CO., LTD

2.Summary

TFT 5.0" is a color active matrix thin film transistor (TFT) liquid crystal display (LCD) that uses amorphous silicon TFT as a switching device. This TFT LCD has a 4.99 (16:9) inch diagonally measured active display area with HD (720 horizontal by 1280 vertical pixel) resolution. This module is a composed of a TFT_LCD module and follows RoHs.

WINSTAR DISPLAY CO., LTD

3.General Specifications

Item	Dimension	Unit
Size	5.0	inch
Dot Matrix	720× 3(RGB) ×1280	dots
Module dimension	68.4 (W) × 122.7 (H) ×4.15	mm
Active area	62.1 (W) × 110.4 (H)	mm
Dot pitch	0.08625(W) ×0.08625(H)	mm
LCD type	TFT, Normally Black, Transmissive	
Viewing angle	80/80/80/80	
TFT Drive IC	ILI9881C or Equivalent	
TFT Interface	4-Lanes MIPI	
Aspect Ratio	16:9	
Backlight Type	LED ,Normally White	
With /Without TP	Without TP	
Surface	Glare	

*Color tone slight changed by temperature and driving voltage.

4. Absolute Maximum Ratings

Item	Symbol	Min	Typ	Max	Unit
Operating Temperature	TOP	-20	—	+70	°C
Storage Temperature	TST	-30	—	+80	°C

Note: Device is subject to be damaged permanently if stresses beyond those absolute maximum ratings listed above

1. Temp. 60°C, 90% RH MAX. Temp. > 60°C, Absolute humidity shall be less than 90% RH at 60°C

5. Electrical Characteristics

5.1. Typical Operation Conditions

Item	Symbol	Values			Unit	Remark
		Min.	Typ.	Max.		
Power supply for analog circuit	VCI	2.5	3.3	3.6	V	
Power supply for logic circuit	IOVCC	1.65	1.8	3.6	V	
Current for Driver	IDD	-	44	-	mA	VDD=3.3V

5.2. Backlight Driving Conditions

Parameter	Symbol	Min.	Typ.	Max.	Unit	Remark
LED current	I _{LED}	-	160	-	mA	
LED voltage	V _{LED+}	18.2	21	23.8	V	Note 1
LED Life Time		50,000	-	-	Hr	Note 2,3,4

Note 1 : There are 1 Groups LED

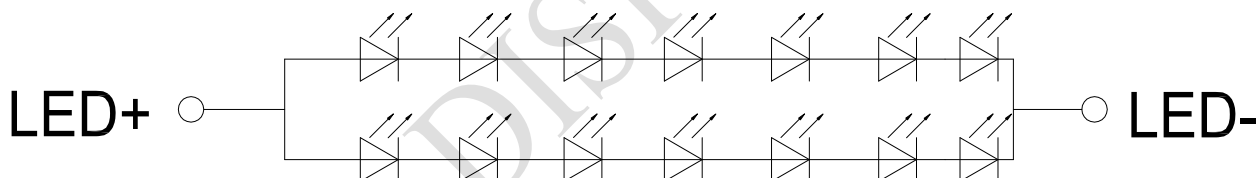

B/L CIRCUIT DIAGRAM

Note 2 : $T_a = 25\text{ }^\circ\text{C}$

Note 3 : Brightness to be decreased to 50% of the initial value

Note 4 : The single LED lamp case

6.DC CHARATERISTICS

6.1. Basic Characteristics for Panel Driving

Parameter	Symbol	Rating			Unit	Condition	Note
		Min	Typ	Max			
Logic Low level input voltage	V_{IL}	-0.3	-	$0.3 \cdot IOVCC$	V		Note1
Logic High level input voltage	V_{IH}	$0.7 \cdot IOVCC$	-	$IOVCC$	V		Note1
Logic Low level output voltage (TE)	V_{OL}	0		$0.2 \cdot IOVCC$	V	$I_{OL} = +1.0mA$	Note1
Logic High level output voltage (TE)	V_{OH}	$0.8 \cdot IOVCC$		$IOVCC$	V	$I_{OH} = -1.0mA$	Note1

NOTE1:

$T_a = -20$ to $70^\circ C$, $V_{CI} = 2.5V$ to $3.6V$, $IOVCC = 1.65V$ to $3.6V$

6.2. DSI DC Characteristics

LP Mode

Parameter	Symbol	Condition	Specification			Unit
			Min.	Typ.	Max.	
Logic 1 input voltage	V_{IHLPCD}	LP-CD	450	-	1350	mV
Logic 0 input voltage	V_{ILLPCD}	LP-CD	0.0	-	200	mV
Logic 1 input voltage	V_{IHLPRX}	LP-RX (CLK, D0, D1, D2, D3)	880	-	1350	mV
Logic 0 input voltage	V_{ILLPRX}	LP-RX (CLK, D0, D1, D2, D3)	0.0	-	550	mV
Logic 0 input voltage	$V_{ILLPRXULP}$	LP-RX (CLK ULP mode)	0.0	-	300	mV
Logic 1 output voltage	V_{OHLPTX}	LP-TX (D0)	1.1	-	1.3	V
Logic 0 output voltage	V_{OLLPTX}	LP-TX (D0)	-50	-	50	mV
Logic 1 input current	I_{IH}	LP-CD, LP-RX	-	-	10	μA
Logic 0 input current	I_{IL}	LP-CD, LP-RX	-10	-	-	μA

Spike/Glitch Rejection

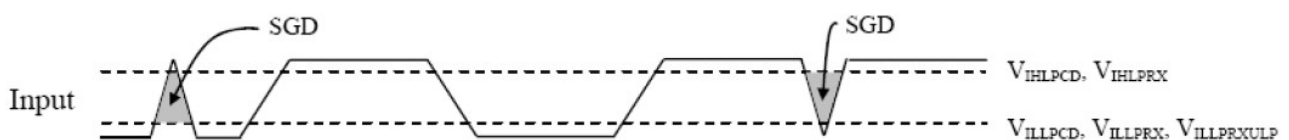

Spike/Glitch Rejection – DSI					
Signal	Symbol	Parameter	Min	Max	Unit
CLKP/N, DnP/N	SGD	Input pulse rejection for DSI	-	300	Vps

High Speed Mode

Parameter	Symbol	Condition	Specification			Unit
Input Common Mode Voltage for Clock	V_{CMCLK}	CLKP/N Note 2, Note 3	70	-	330	mV
Input Common Mode Voltage for Data	V_{CMDATA}	DnP/N Note 2, Note 3, Note 5	70	-	330	mV
Common Mode Ripple for Clock Equal or Less than 450MHz	$V_{CMRCLKL450}$	CLKP/N Note 4	-50	-	50	mV
Common Mode Ripple for Data Equal or Less than 450MHz	$V_{CMRDATA450}$	DnP/N Note 4, Note 5	-50	-	50	mV
Common Mode Ripple for Clock More than 450MHz (peak sine wave)	$V_{CMRCLKM450}$	CLKP/N	-	-	100	mV
Common Mode Ripple for Data More than 450MHz (peak sine wave)	$V_{CMRDATA450}$	DnP/N Note 5	-	-	100	mV
Differential Input Low Level Threshold Voltage for Clock	V_{THCLK-}	CLKP/N	-70	-	-	mV
Differential Input Low Level Threshold Voltage for Data	$V_{THDATA-}$	DnP/N Note 5	-70	-	-	mV
Differential Input High Level Threshold Voltage for Clock	V_{THCLK+}	CLKP/N	-	-	70	mV
Differential Input High Level Threshold Voltage for Data	$V_{THDATA+}$	DnP/N Note 5	-	-	70	mV
Single-ended Input Low Voltage	V_{ILHS}	CLKP/N, DnP/N Note 3, Note 5	-40	-	-	mV
Single-ended Input High Voltage	V_{IHHS}	CLKP/N, DnP/N Note 3, Note 5	-	-	460	mV
Differential Termination Resistor	R_{TERM}	CLKP/N, DnP/N Note 5	80	100	125	Ω
Single-ended Threshold Voltage for Termination Enable	V_{TERMEN}	CLKP/N, DnP/N Note 5	-	-	450	mV
Termination Capacitor	C_{TERM}	CLKP/N, DnP/N Note 5, Note 6	-	-	60	pF

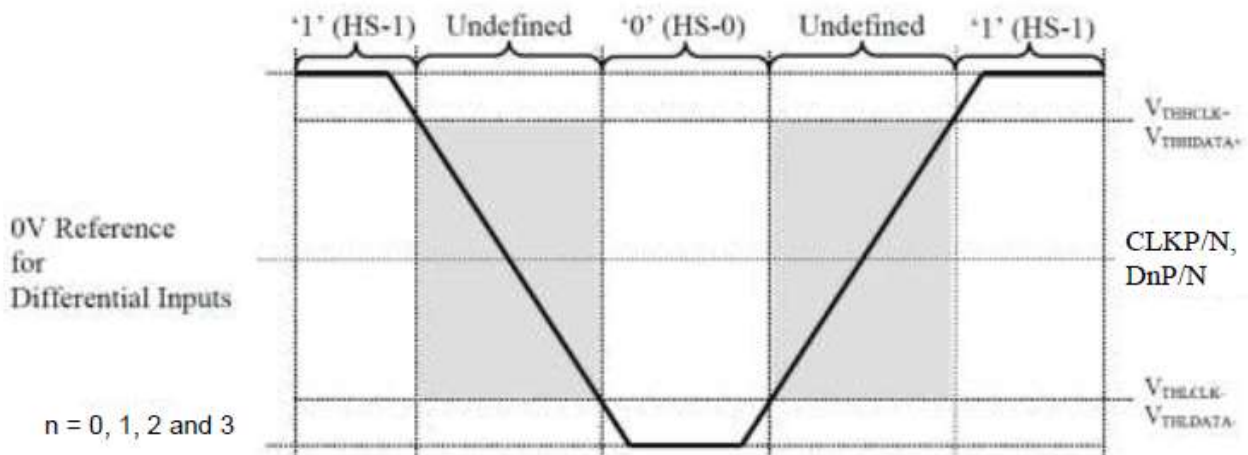

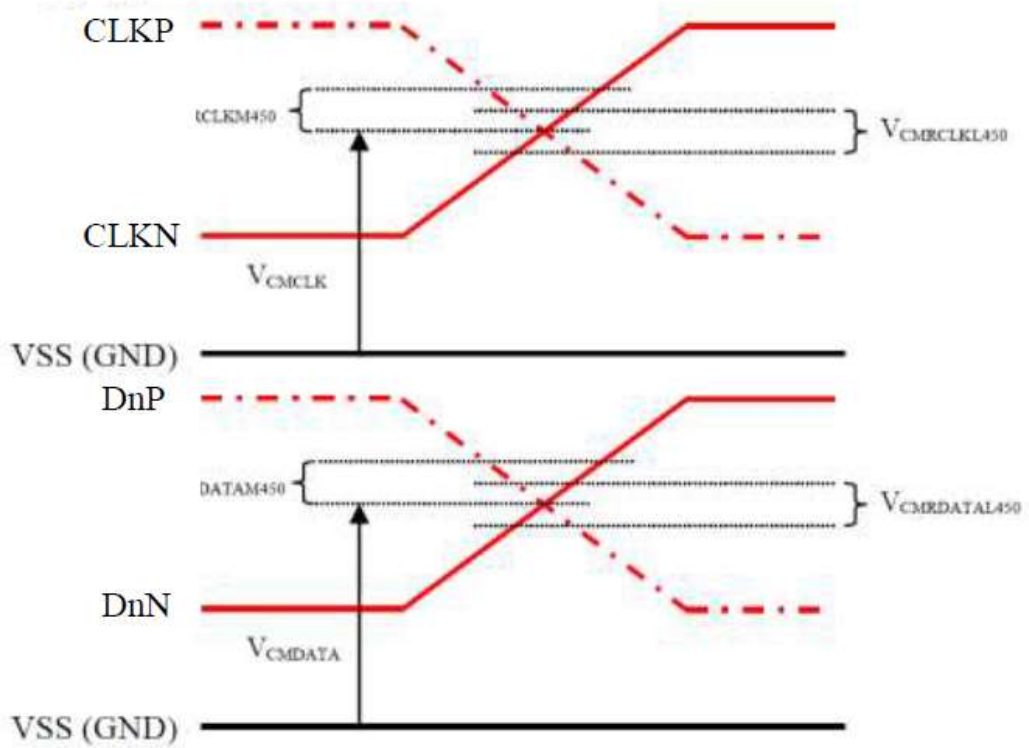

Note: $n = 0, 1, 2$ and 3

WINSTAR DISPL

7.AC Characteristics

7.1. DSI Interface Timing Characteristics

7.1.1 High Speed Mode – Clock Channel Timing

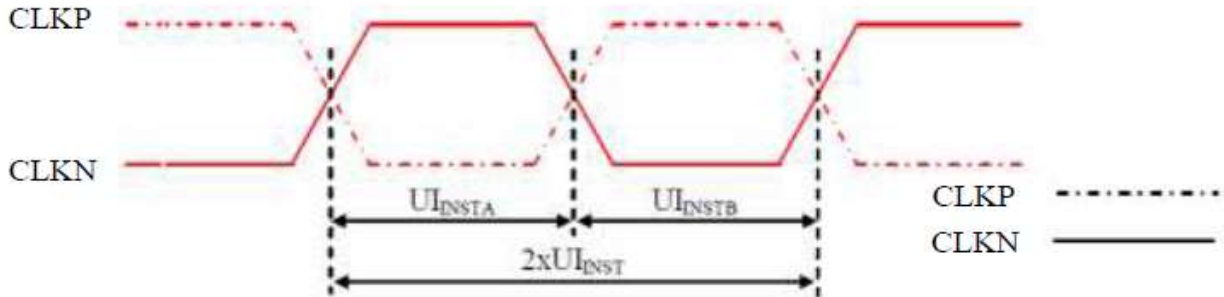

Signal	Symbol	Parameter	Min	Max	Unit
CLKP/N	$2xUI_{INST}$	Double UI instantaneous	Note 2	25	ns
CLKP/N	UI_{INSTA}, UI_{INSTB} (Note 1)	UI instantaneous Half	Note 2	12.5	ns

Notes:

1. $UI = UI_{INSTA} = UI_{INSTB}$

Data type	Two Lanes speed	Three Lanes speed	Four Lanes speed
Data Type = 00 1110 (0Eh), RGB 565, 16 UI per Pixel	566 Mbps	466 Mbps	366 Mbps
Data Type = 01 1110 (1Eh), RGB 666, 18 UI per Pixel	637 Mbps	525 Mbps	412 Mbps
Data Type = 10 1110 (2Eh), RGB 666 Loosely, 24 UI per Pixel	850 Mbps	700 Mbps	550 Mbps
Data Type = 11 1110 (3Eh), RGB 888, 24 UI per Pixel	850 Mbps	700 Mbps	550 Mbps

7.1.2 High Speed Mode – Data Clock Channel Timing

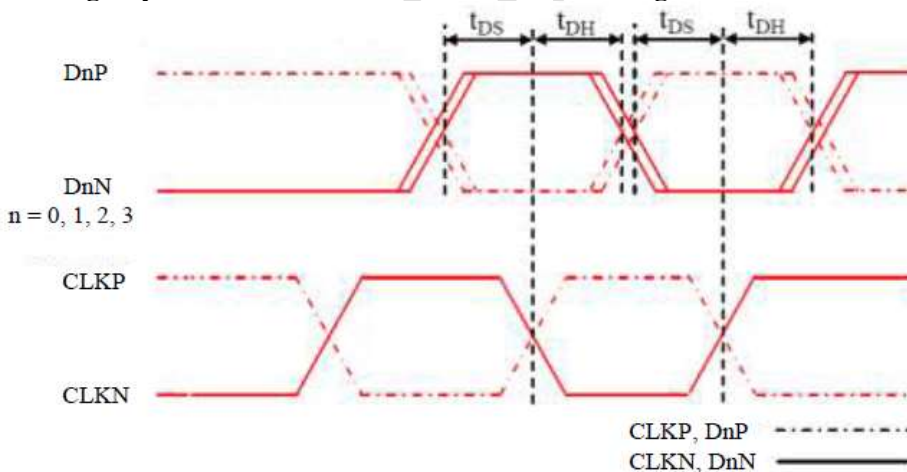

Signal	Symbol	Parameter	Min	Max
DnP/N, n=0 and 1	t_{DS}	Data to Clock Setup time	$0.15xUI$	-
	t_{DH}	Clock to Data Hold Time	$0.15xUI$	-

7.1.3 High Speed Mode – Rising and Falling Timings

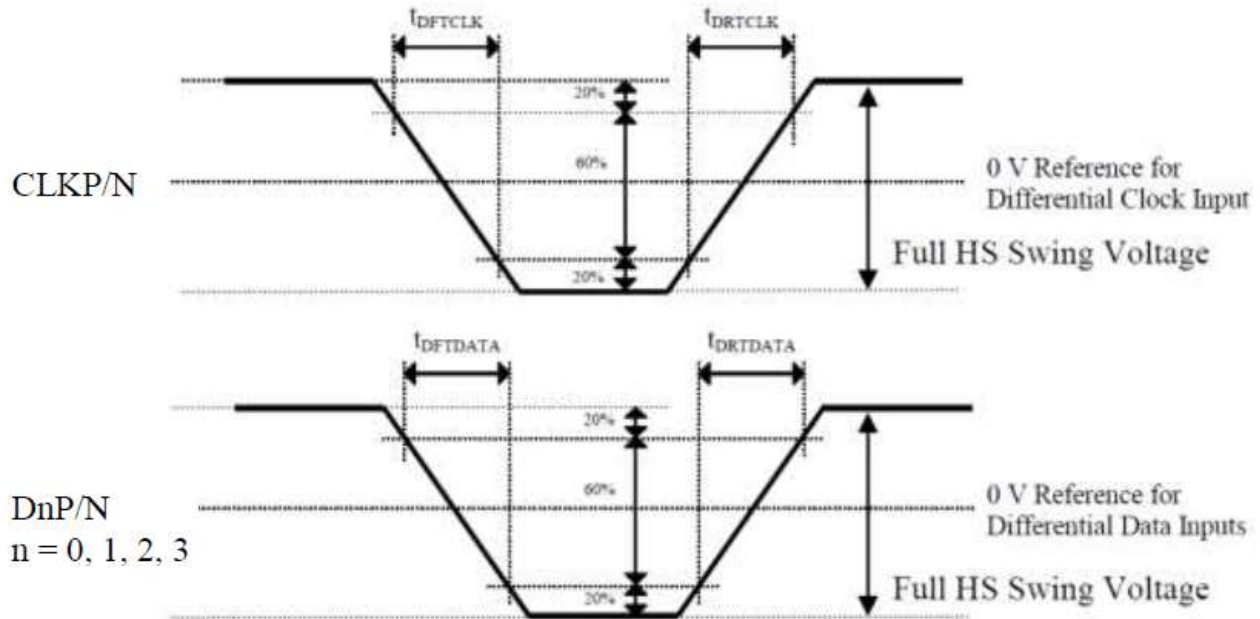
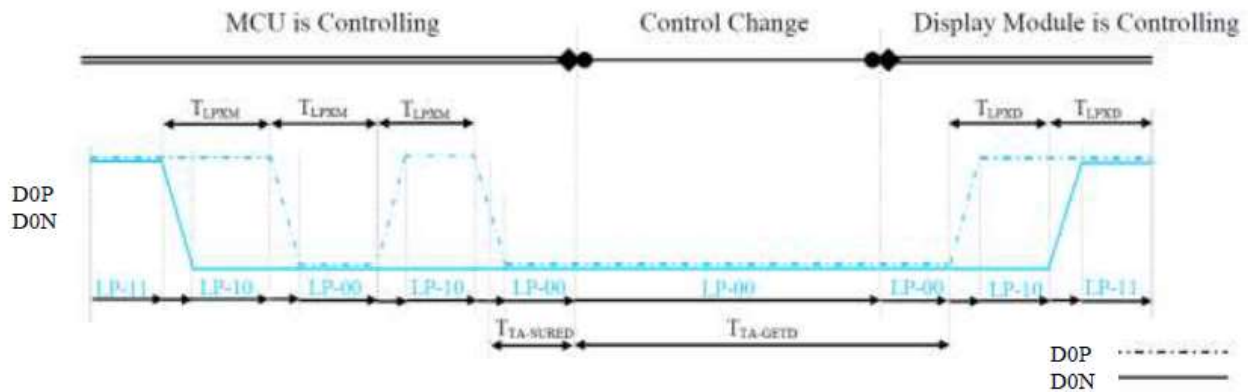

Table 41: Rise and Fall Timings on Clock and Data Channels

Parameter	Symbol	Condition	Specification		
			Min	Typ	Max
Differential Rise Time for Clock	t_{DRTCLK}	CLKP/N	150 ps	-	0.3UI (Note)
Differential Rise Time for Data	$t_{DRTDATA}$	DnP/N n=0 and 1	150 ps	-	0.3UI (Note)
Differential Fall Time for Clock	t_{DFTCLK}	CLKP/N	150 ps	-	0.3UI (Note)
Differential Fall Time for Data	$t_{DFTDATA}$	DnP/N n=0 and 1	150 ps	-	0.3UI (Note)

Note: The display module has to meet timing requirements, which are defined for the transmitter (MCU) on MIPI D-Phy standard.

7.1.4 Low Power Mode – Bus Turn Around



BTA from the MCU to Display Module

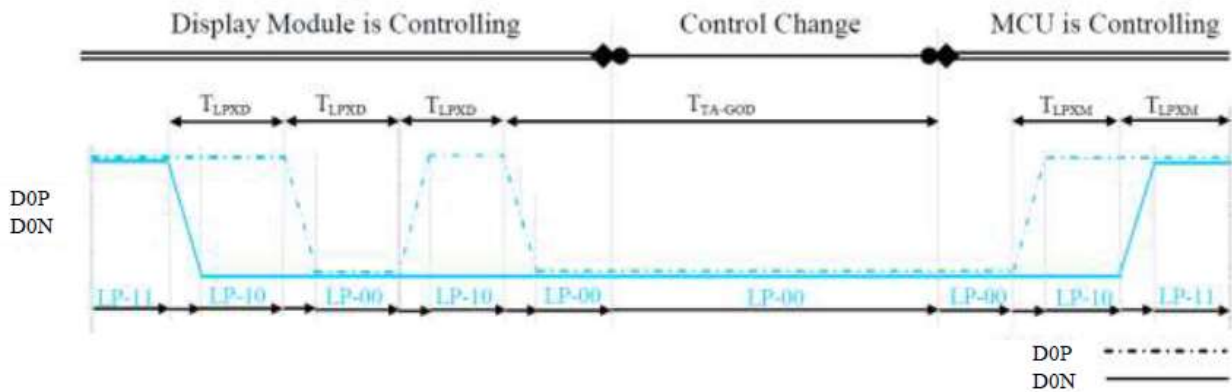

BTA from Display Module to the MCU

Signal	Symbol	Description	Min	Max	Unit
D0P/N	T_{LPXM}	Length of LP-00, LP-01, LP-10 or LP-11 periods MCU → Display Module (ILI9881C)	50	75	ns
D0P/N	T_{LPXD}	Length of LP-00, LP-01, LP-10 or LP-11 periods Display Module (ILI9881C) → MCU	50	75	ns
D0P/N	$T_{TA-SURED}$	Time-out before the Display Module (ILI9881C) starts driving	T_{LPXD}	$2 \times T_{LPXD}$	ns

Signal	Symbol	Description	Time	Unit
D0P/N	$T_{TA-GETD}$	Time to drive LP-00 by Display Module (ILI9881C)	$5 \times T_{LPXD}$	ns
D0P/N	T_{TA-GOD}	Time to drive LP-00 after turnaround request - MCU	$4 \times T_{LPXD}$	ns

7.1.5 Data Lanes from Low Power Mode to High Speed Mode

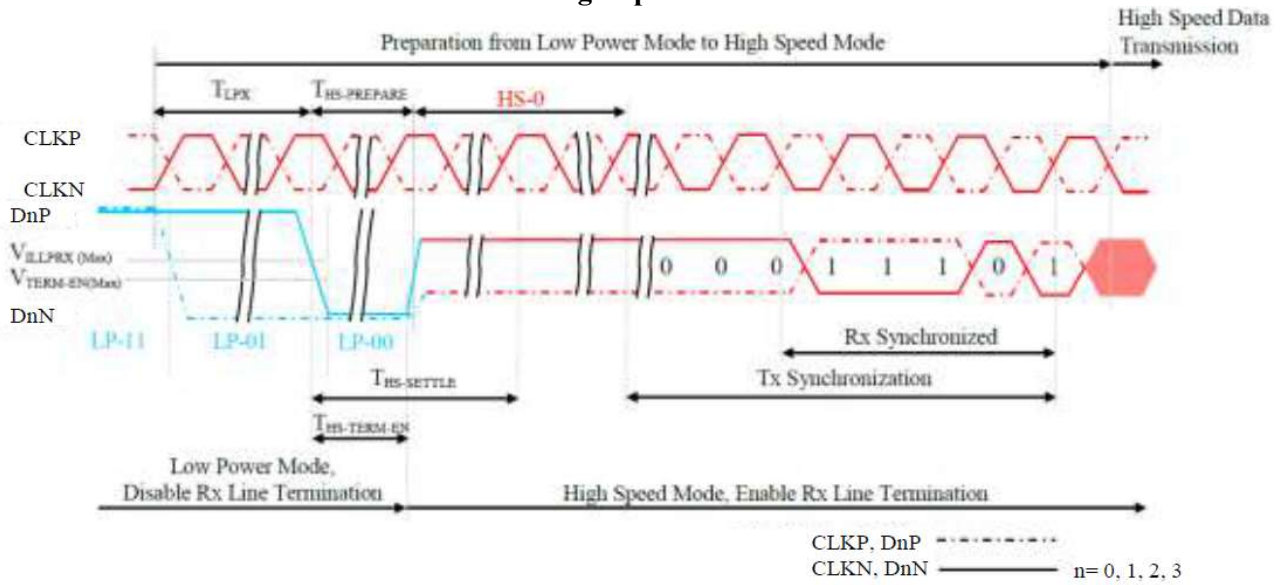

Signal	Symbol	Description	Min	Max	Unit
DnP/N, n = 0 and 1	T_{LPX}	Length of any Low Power State Period	50	-	ns
DnP/N, n = 0 and 1	$T_{HS-PREPARE}$	Time to drive LP-00 to prepare for HS Transmission	$40+4xUI$	$85+6xUI$	ns
DnP/N, n = 0 and 1	$T_{HS-TERM-EN}$	Time to enable Data Lane Receiver line termination measured from when Dn crosses V_{ILMAX}	-	$35+4xUI$	ns

7.1.6 Data Lanes from High Speed Mode to Low Power Mode

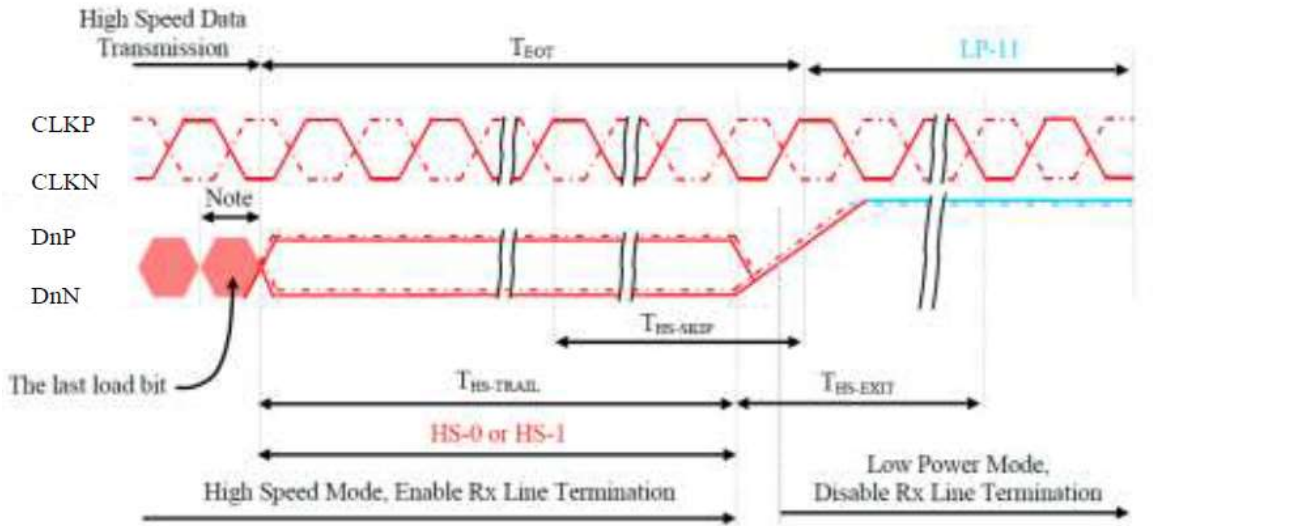

Note:
 If the last load bit is HS-1, the transmitter changes from HS-1 to HS-0.
 If the last load bit is HS-0, the transmitter changes from HS-0 to HS-1.

CLKP, DnP -----
 CLKN, DnN _____
 n = 0, 1, 2, 3

Signal	Symbol	Description	Min	Max	Unit
DnP/N, n = 0 and 1	$T_{HS-SKIP}$	Time-Out at Display Module (LI9881C) to ignore transition period of EoT	40	$55+4xUI$	ns
DnP/N, n = 0 and 1	$T_{HS-EXIT}$	Time to driver LP-11 after HS burst	100	-	ns

7.1.7 Clock Lanes High Speed Mode to/from Low Power Mode Timing

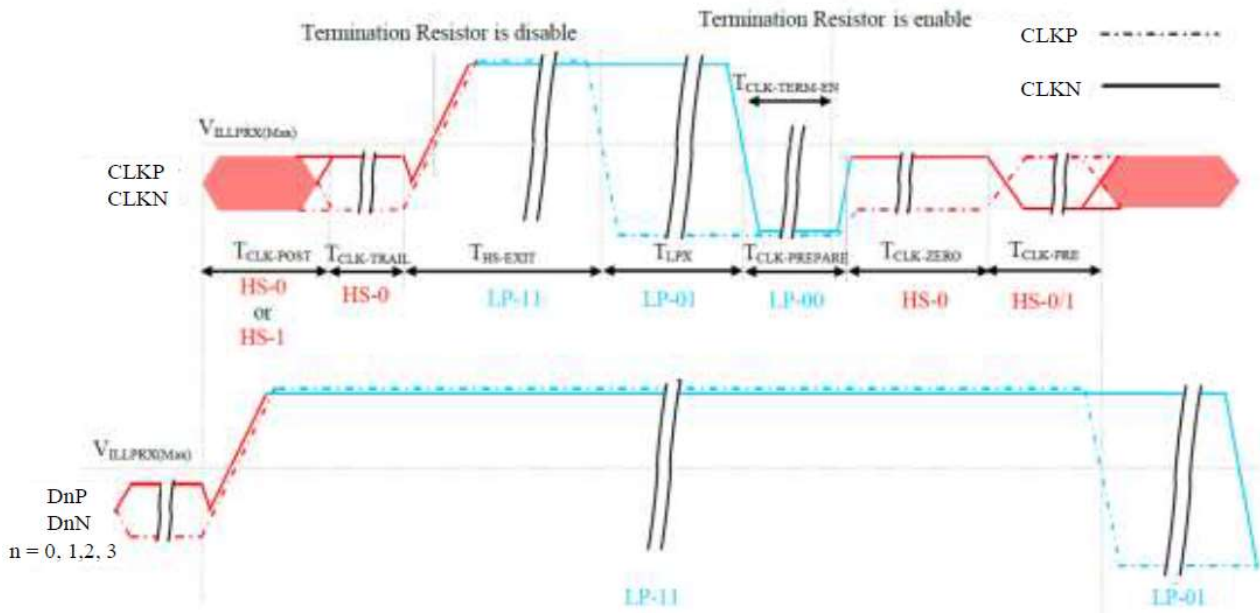

Signal	Symbol	Description	Min	Max	Unit
CLKP/N	$T_{CLK-POST}$	Time that the MCU shall continue sending HS clock after the last associated Data Lanes has transitioned to LP mode	$60+52xUI$	-	ns
CLKP/N	$T_{CLK-TRAIL}$	Time to drive HS differential state after last payload clock bit of a HS transmission burst	60	-	ns
CLKP/N	$T_{HS-EXIT}$	Time to drive LP-11 after HS burst	100	-	ns
CLKP/N	$T_{CLK-PREPARE}$	Time to drive LP-00 to prepare for HS transmission	38	95	ns
CLKP/N	$T_{CLK-TERM-EN}$	Time-out at Clock Lane to enable HS termination	-	38	ns
CLKP/N	$T_{CLK-PREPARE} + T_{CLK-ZERO}$	Minimum lead HS-0 drive period before starting Clock	300	-	ns
CLKP/N	$T_{CLK-PRE}$	Time that the HS clock shall be driven prior to any associated Data Lane beginning the transition from LP to HS mode	$8xUI$	-	ns

7.2. Reset Timing

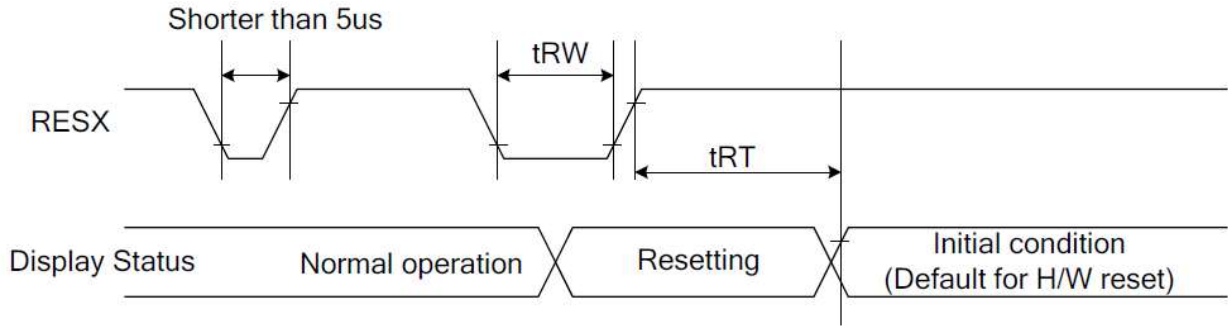

Signal	Symbol	Parameter	Min	Max	Unit
RESX	tRW	Reset pulse duration	10		us
	tRT	Reset cancel		5 (Note 1, 5) 120 (Note 1, 6, 7)	ms

Notes:

1. The reset cancel includes also required time for loading ID bytes, VCOM setting and other settings from NVM (or similar device) to registers. This loading is done every time when there is HW reset cancel time (tRT) within 5 ms after a rising edge of RESX.
2. Spike due to an electrostatic discharge on RESX line does not cause irregular system reset according to the table below:

RESX Pulse	Action
Shorter than 5us	Reset Rejected
Longer than 10us	Reset
Between 5us and 10us	Reset starts

3. During the Resetting period, the display will be blanked (The display is entering blanking sequence, which maximum time is 120 ms, when Reset Starts in Sleep Out –mode. The display remains the blank state in Sleep In –mode.) and then return to Default condition for Hardware Reset.
4. Spike Rejection also applies during a valid reset pulse as shown below:

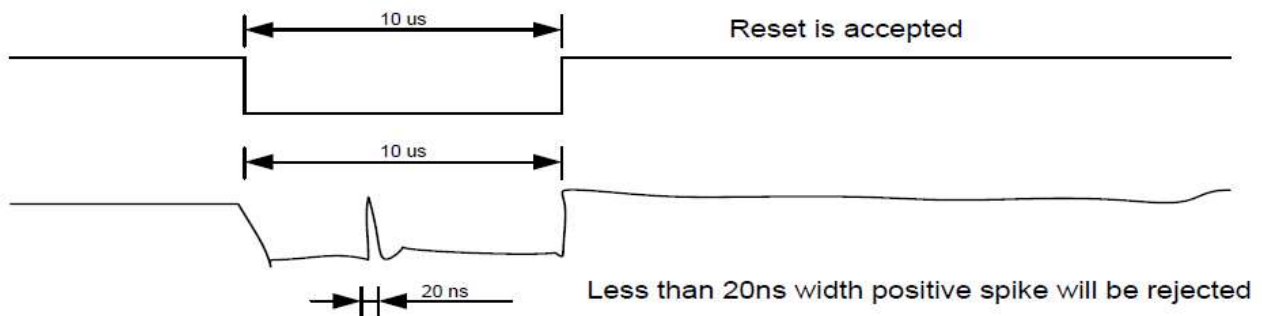

5. When Reset applied during Sleep In Mode.
6. When Reset applied during Sleep Out Mode.
7. It is necessary to wait 5msec after releasing RESX before sending commands. Also Sleep Out command cannot be sent for 120msec.

8. Power ON/OFF Sequence

Case A:

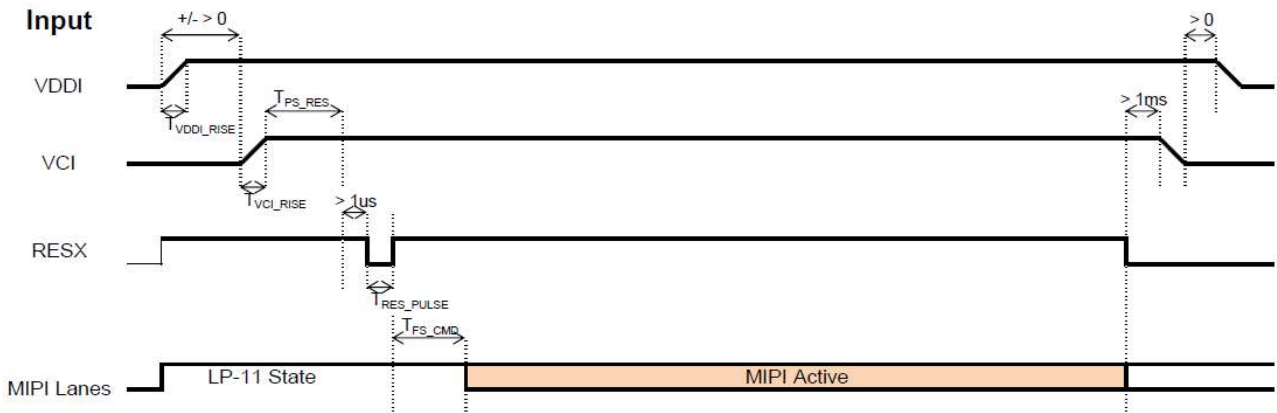

Case B:

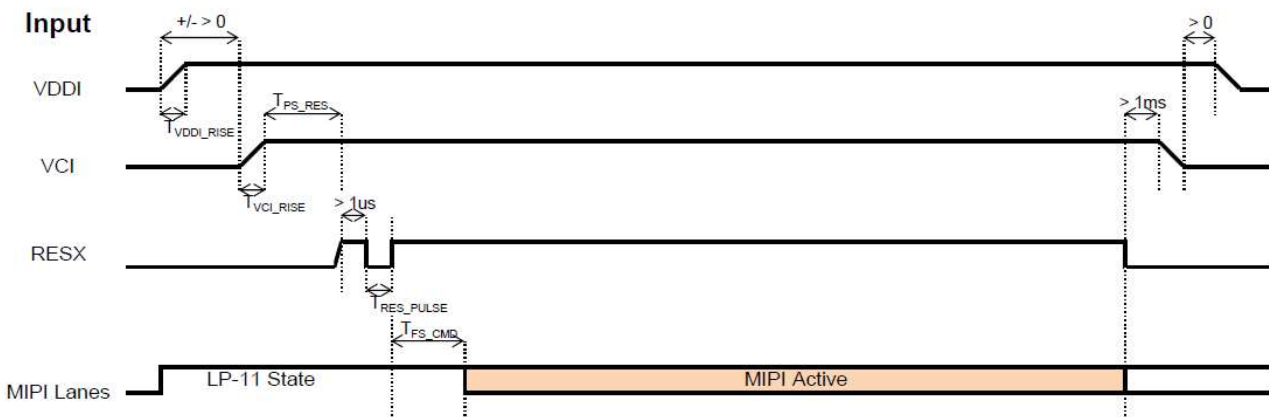

Symbol	Characteristics	Min.	Typ.	Max.	Units
T_{VDDI_RISE}	VDDI Rise time	10	-	-	us
T_{VCI_RISE}	Case A: VCI Rise time	130	-	-	us
	Case B: VCI Rise time	40	-	-	us
T_{PS_RES}	VDDI/VCI on to Reset high	5	-	-	ms
T_{RES_PULSE}	Reset low pulse time	10	-	-	us
T_{FS_CMD}	Reset to first command	10	-	-	ms

9. Optical Characteristics

Item	Symbol	Condition.	Min	Typ.	Max.	Unit	Remark	
Response time	Tr	$\theta=0^\circ$ 、 $\phi=0^\circ$	-	10	15	.ms	Note 3	
	Tf		-	20	25	.ms		
Contrast ratio	CR	At optimized viewing angle	640	800	-	-	Note 4	
Color Chromaticity	White	Wx	$\theta=0^\circ$ 、 $\phi=0^\circ$	0.26	0.31	0.36	Note 2,6,7	
		Wy		0.28	0.33	0.38		
Viewing angle	Hor.	θ_R	CR 10	-	80	-	Deg.	Note 1
		θ_L		-	80	-		
	Ver.	ϕ_T		-	80	-		
		ϕ_B		-	80	-		
Brightness	-	-	1000	1100	-	cd/m2	Center of display	
Uniformity	(U)	-	75	-	-	%	Note 5	

Ta=25±2°C

Note 1: Definition of viewing angle range

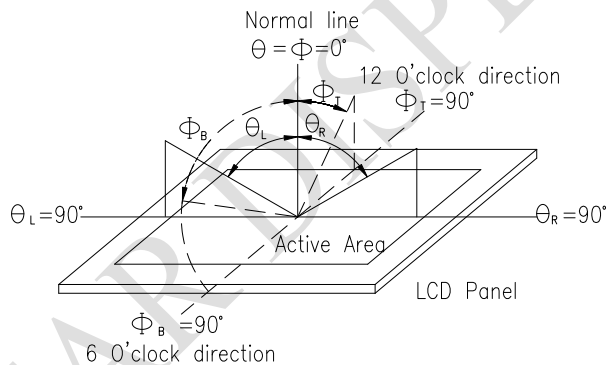

Fig. 9.1. Definition of viewing angle

Note 2: Test equipment setup:

After stabilizing and leaving the panel alone at a driven temperature for 10 minutes, the measurement should be executed. Measurement should be executed in a stable, windless, and dark room. Optical specifications are measured by Topcon BM-7 or BM-5 luminance meter 1.0° field of view at a distance of 50cm and normal direction.

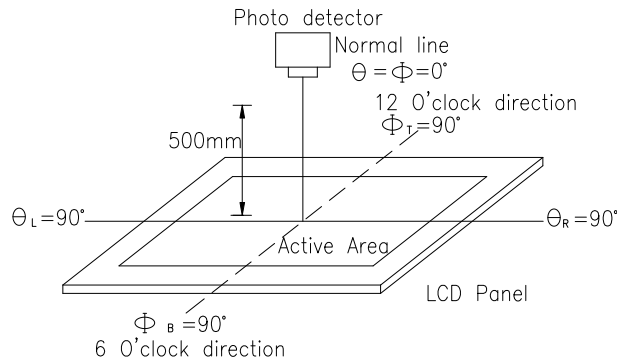
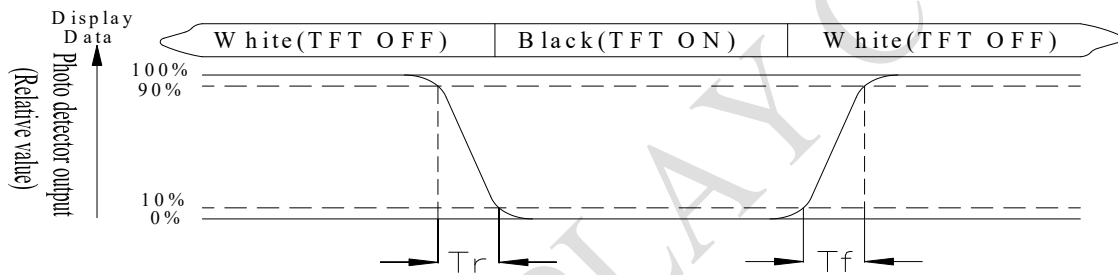

Fig. 9.2. Optical measurement system setup

Note 3: Definition of Response time:

The response time is defined as the LCD optical switching time interval between “White” state and “Black” state. Rise time, T_r , is the time between photo detector output intensity changed from 90% to 10%. And fall time, T_f , is the time between photo detector output intensity changed from 10% to 90%



Note 4: Definition of contrast ratio:

The contrast ratio is defined as the following expression.

$$\text{Contrast ratio (CR)} = \frac{\text{Luminance measured when LCD on the "White" state}}{\text{Luminance measured when LCD on the "Black" state}}$$

Note 5: Definition of Luminance Uniformity

Active area is divided into 9 measuring areas (reference the picture in below). Every measuring point is placed at the center of each measuring area.

$$\text{Luminance Uniformity (U)} = L_{\min}/L_{\max} \times 100\%$$

L = Active area length

W = Active area width

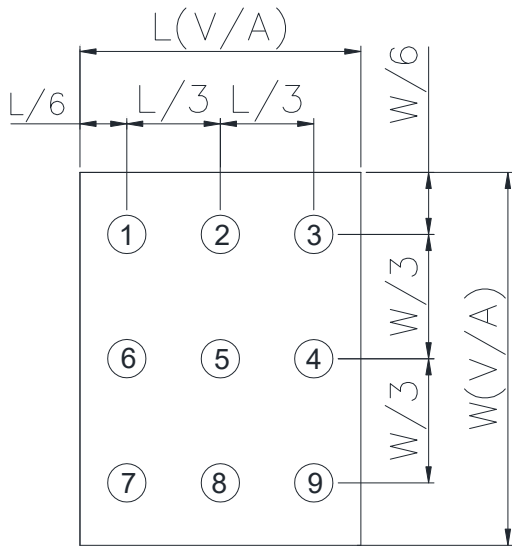

Fig 9.3. Definition of uniformity

Note 6: Definition of color chromaticity (CIE 1931)
Color coordinates measured at the center point of LCD

Note 7: Measured at the center area of the panel when all the input terminals of LCD panel are electrically opened.

10.Interface

10.1. LCM PIN Definition

Pin	Symbol	Function	Remark
1-9	NC	No connection	
10-11	VCI	Power supply for analog circuits. Connect to an external power supply of 2.5V to 3.6V	
12-13	NC	No connection	
14	RESET	The external reset input Initializes the chip with a low input. Be sure to execute a power-on reset after supplying power. Fix to VDDI level when not in use.	
15	TE	Tearing effect output pin. Leave the pin open when not in use.	
16	NC	No connection	
17-18	GND	Power ground	
19-20	IOVCC	Power supply for analog circuits. Connect to an external power supply of 1.65V to 3.6V	
21	GND	Power ground	
22	D3P	MIPI DSI differential data pair. (Data lane 3)	
23	D3N		
24	GND	Power ground	
25	D2P	MIPI DSI differential data pair. (Data lane 2)	
26	D2N		
27	GND	Power ground	
28	CLKP	MIPI DSI differential clock pair	
29	CLKN		
30	GND	Power ground	
31	D1P	MIPI DSI differential data pair. (Data lane 1)	
32	D1N		
33	GND	Power ground	
34	D0P	MIPI DSI differential data pair. (Data lane 0)	
35	D0N		
36-37	GND	Power ground	
38	LED+	Power for LED backlight anode	
39	LED-	Power for LED backlight cathode	
40	NC	No connection	

WINSTAR DISPLAY CO., LTD

11. Reliability

Content of Reliability Test (Wide temperature, -20°C~70°C)

Environmental Test			
Test Item	Content of Test	Test Condition	Note
High Temperature storage	Endurance test applying the high storage temperature for a long time.	80°C 200hrs	2
Low Temperature storage	Endurance test applying the low storage temperature for a long time.	-30°C 200hrs	1,2
High Temperature Operation	Endurance test applying the electric stress (Voltage & Current) and the thermal stress to the element for a long time.	70°C 200hrs	—
Low Temperature Operation	Endurance test applying the electric stress under low temperature for a long time.	-20°C 200hrs	1
High Temperature/ Humidity Operation	The module should be allowed to stand at 60°C,90%RH max	60°C,90%RH 96hrs	1,2
Thermal shock resistance	The sample should be allowed stand the following 10 cycles of operation <div style="text-align: center;"> <p style="margin: 0;">-20°C 25°C 70°C</p> <p style="margin: 0;">30min 5min 30min</p> <p style="margin: 0;">1 cycle</p> </div>	-20°C/70°C 10 cycles	—
Vibration test	Endurance test applying the vibration during transportation and using.	Total fixed amplitude : 1.5mm Vibration Frequency : 10~55Hz One cycle 60 seconds to 3 directions of X,Y,Z for Each 15 minutes	3
Static electricity test	Endurance test applying the electric stress to the terminal.	VS=±600V(contact), ±800v(air), RS=330Ω CS=150pF 10 times	—

Note1: No dew condensation to be observed.

Note2: The function test shall be conducted after 4 hours storage at the normal Temperature and humidity after remove from the test chamber.

Note3: The packing have to including into the vibration testing.

12. Contour Drawing

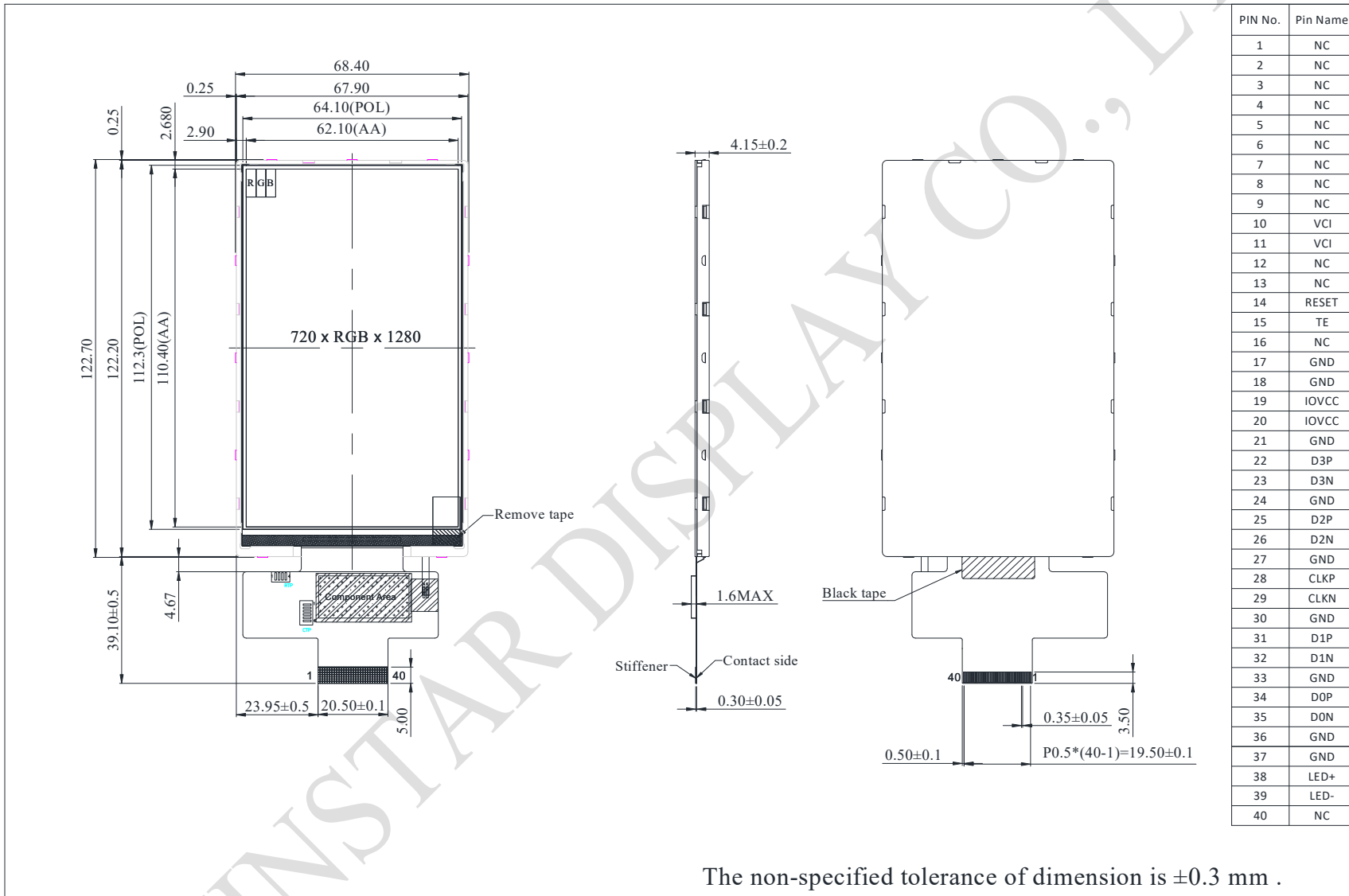



winstar

LCM Sample Estimate Feedback Sheet

Module Number : _____

Page: 1

1、Panel Specification :

- 1. Panel Type : Pass NG , _____
- 2. View Direction : Pass NG , _____
- 3. Numbers of Dots : Pass NG , _____
- 4. View Area : Pass NG , _____
- 5. Active Area : Pass NG , _____
- 6. Operating Temperature : Pass NG , _____
- 7. Storage Temperature : Pass NG , _____
- 8. Others : _____

2、Mechanical

- 1. PCB Size : Pass NG , _____
- 2. Frame Size : Pass NG , _____
- 3. Material of Frame : Pass NG , _____
- 4. Connector Position : Pass NG , _____
- 5. Fix Hole Position : Pass NG , _____
- 6. Backlight Position : Pass NG , _____
- 7. Thickness of PCB : Pass NG , _____
- 8. Height of Frame to PCB : Pass NG , _____
- 9. Height of Module : Pass NG , _____
- 10. Others : Pass NG , _____

3、Relative Hole Size :

- 1. Pitch of Connector : Pass NG , _____
- 2. Hole size of Connector : Pass NG , _____
- 3. Mounting Hole size : Pass NG , _____
- 4. Mounting Hole Type : Pass NG , _____
- 5. Others : Pass NG , _____

4、Backlight Specification :

- 1. B/L Type : Pass NG , _____
- 2. B/L Color : Pass NG , _____
- 3. B/L Driving Voltage (Reference for LED) Pass NG , _____
- 4. B/L Driving Current : Pass NG , _____
- 5. Brightness of B/L : Pass NG , _____
- 6. B/L Solder Method : Pass NG , _____
- 7. Others : Pass NG , _____



Winstar Module Number : _____

Page: 2

5、Electronic Characteristics of Module :

- | | | |
|------------------------------|-------------------------------|-------------------------------------|
| 1. Input Voltage : | <input type="checkbox"/> Pass | <input type="checkbox"/> NG , _____ |
| 2. Supply Current : | <input type="checkbox"/> Pass | <input type="checkbox"/> NG , _____ |
| 3. Driving Voltage for LCD : | <input type="checkbox"/> Pass | <input type="checkbox"/> NG , _____ |
| 4. Contrast for LCD : | <input type="checkbox"/> Pass | <input type="checkbox"/> NG , _____ |
| 5. B/L Driving Method : | <input type="checkbox"/> Pass | <input type="checkbox"/> NG , _____ |
| 6. Negative Voltage Output : | <input type="checkbox"/> Pass | <input type="checkbox"/> NG , _____ |
| 7. Interface Function : | <input type="checkbox"/> Pass | <input type="checkbox"/> NG , _____ |
| 8. LCD Uniformity : | <input type="checkbox"/> Pass | <input type="checkbox"/> NG , _____ |
| 9. ESD test : | <input type="checkbox"/> Pass | <input type="checkbox"/> NG , _____ |
| 10. Others : | <input type="checkbox"/> Pass | <input type="checkbox"/> NG , _____ |

6、Summary :

Sales signature : _____

Customer Signature : _____

Date : / / _____