

| Assembly Specifications |                |
|-------------------------|----------------|
| Temp Rating             | -20 to 80 C    |
| Max Voltage             | 30V            |
| Max Current             | 2A             |
| IP Protection           | IP 67          |
| Length (L)              | 119in / 3023mm |
| Tolerance               | +2.0in -2.0in  |

| Wiring Schematic |                 |         |
|------------------|-----------------|---------|
| A Pin #          | Conductor Color | B Pin # |
| 1                | Black           | 1       |
| 2                | Red             | 2       |
| 3                | Blue            | 3       |
| 4                | Orange          | 4       |
| 5                | Yellow          | 5       |
| 6                | Brown           | 6       |
| 7                | Red/Black       | 7       |
| 8                | Blue/Black      | 8       |
| Shield           |                 | Shield  |

| Cable Specifications |                |
|----------------------|----------------|
| Cable Jacket         | PVC            |
| Cable OD             | 0.22in / 5.6mm |
| No. /Gauge           | M46A-824       |
| Conductor Jacket     | PVC            |
| Shielding            | No             |

**A SIDE**

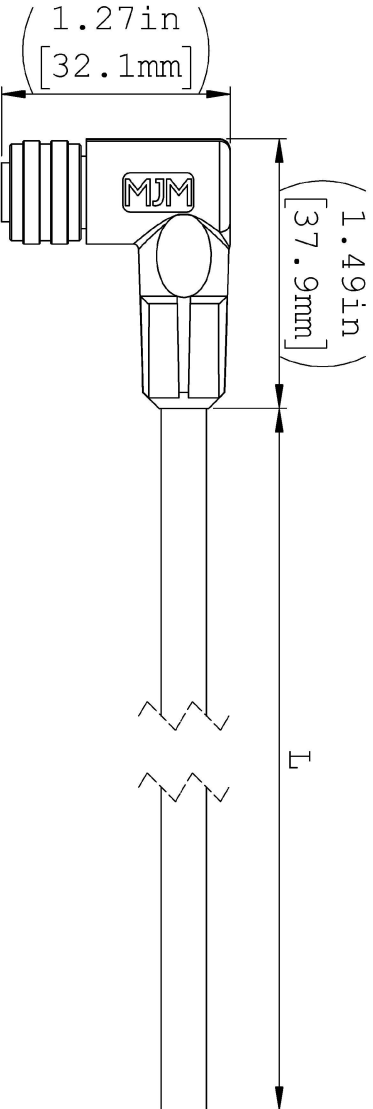

**B SIDE**

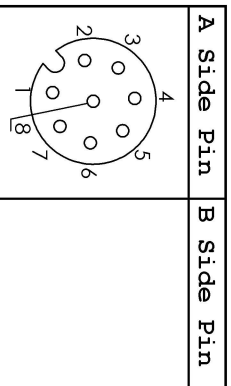

**Notes**

- 1) Connector pin view is from front of connector
- 2) Not for interrupting current
- 3) Some options and features may not be shown
- 4) Additional technical details available upon request; Consult Factory
- 5) Dimension in parentheses are for reference only



Date Gen: 4/18/24

| REV | BY  | DATE     | DESCRIPTION        |
|-----|-----|----------|--------------------|
| 0   | MMG | 01/04/22 | Initial Release    |
| 1   | MMG | 03/16/22 | Production Release |

Tolerance Unless Otherwise Specified  
 0.00 = +/- 0.13  
 0.000 = +/- 0.050  
 ANGLES = +/- 5  
 Secondary Unit for Reference Only



1200 East St, Fairport, OHIO 44077  
 PH: (440) 350-1230 [www.mjmindustries.com](http://www.mjmindustries.com)  
 Part Number: **M12A08F9-0119A-X01**  
 Description: M12 A Coded 8 Position Female 90 to Blunt Cut with 119in of PVC Cable