

Assembly Specifications	
Temp Rating	-20 to 80 C
Max Voltage	60V
Max Current	4A
IP Protection	IP 67
Length (L)	79in / 2007mm
Tolerance	+2.0in -2.0in

Wiring Schematic		
A Pin #	Conductor Color	B Pin #
1	Black	1
2	Red	2
3	Blue	3
4	Orange	4
5	Yellow	5
6		6
7		7
8		8
	Shield	Shield

Cable Specifications	
Cable Jacket	PVC
Cable OD	0.20in / 5.0mm
No. /Gauge	M46A-522
Conductor Jacket	PVC
Shielding	No

A SIDE

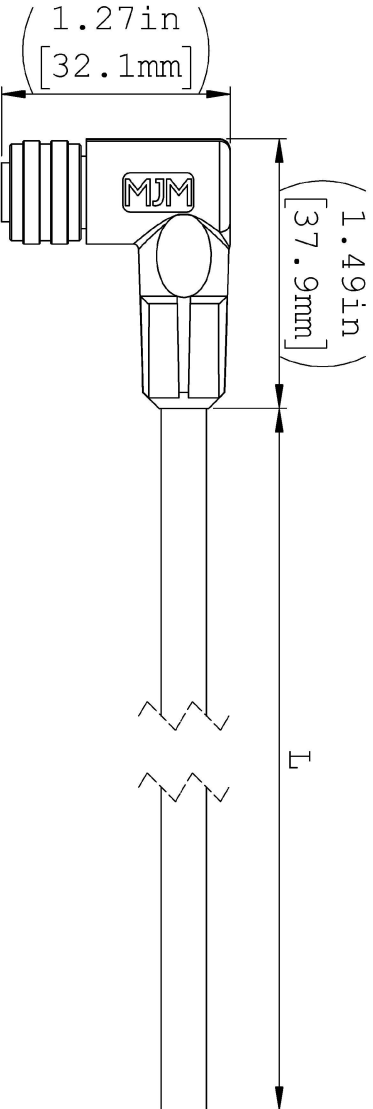

B SIDE

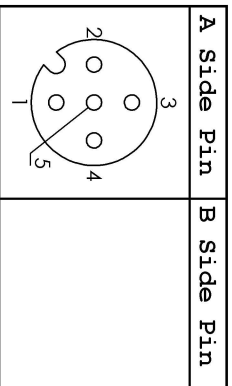

Notes

- 1) Connector pin view is from front of connector
- 2) Not for interrupting current
- 3) Some options and features may not be shown
- 4) Additional technical details available upon request; Consult Factory
- 5) Dimension in parentheses are for reference only



Date Gen: 4/18/24

REV	BY	DATE	DESCRIPTION
0	MMG	01/04/22	Initial Release
1	MMG	03/16/22	Production Release

Tolerance Unless Otherwise Specified
 0.00 = +/- 0.13
 0.000 = +/- 0.050
 ANGLES = +/- 5
 Secondary Unit for Reference Only



1200 East St, Fairport, OHIO 44077
 PH: (440) 350-1230 www.mjmindustries.com
 Part Number:
M12A05F9-0079A-X01
 Description:
 M12 A Coded 5 Position Female 90 to Blunt Cut with 79in of PVC Cable