

CP SERIES

2-Jaw General Industrial Grippers | Features and Benefits | How To Order

Features:

- Compact cam lever design general purpose square gripper
- Two jaw styles available, parallel or extended finger jaw
- Spring assist option for part retention in case of air pressure loss
- Standard and extended stroke option available
- Shielded design for harsh environments
- Magneto-resistive and Inductive sensing

Applications:

- OEM pick and place machines
- Packaging applications
- General purpose gripping

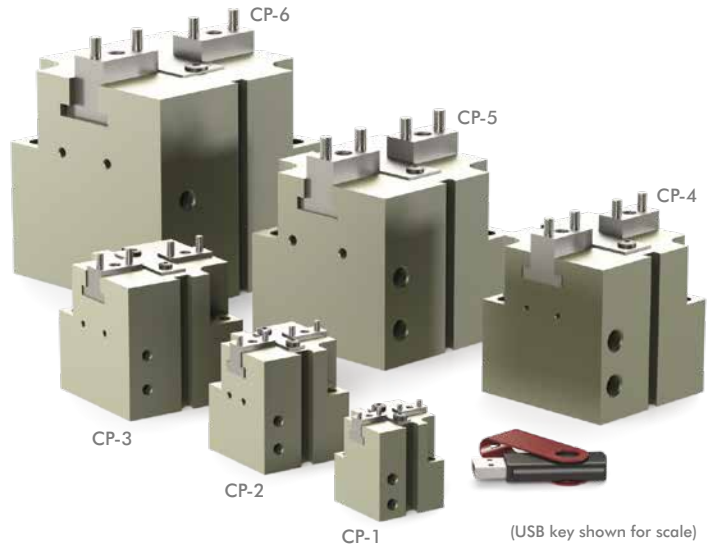

How To Order

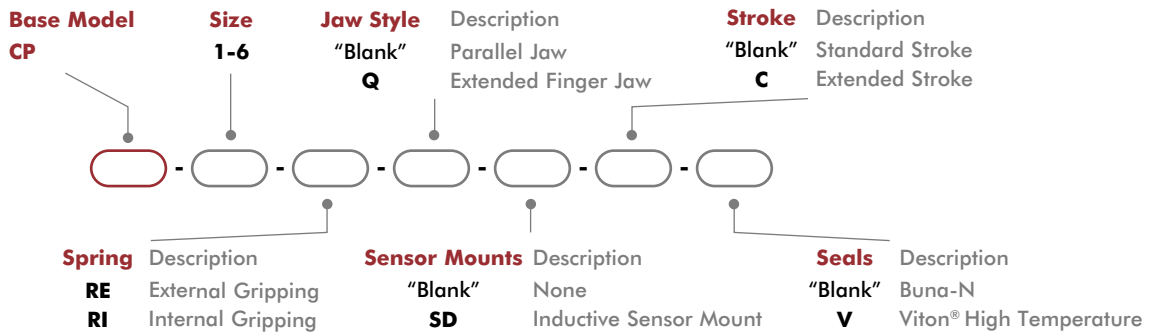

Accessories

Sensor Accessories	Model Numbers	Part Number	Qty/Unit
PNP Sensor with 0.3m Output Cable with 90° with M8 connector*	All Models	D1	1-2
NPN Sensor with 0.3m Output Cable with 90° with M8 connector*	CP-2, -3, -4, -5, -6	D10	1-2
PNP Sensor with 0.3m Output Cable with M8 connector*	All Models	D4	1-2
NPN Sensor with 0.3m Output Cable with M8 connector*	CP-2, -3, -4, -5, -6	D7	1-2
Inductive Sensor Mounting Kit (mounts 2 sensors) (SD)	See Datasheet		1
Inductive PNP Sensor with M8 Connector*	CP-2, -3, -4	OISP-011	1-2
Inductive NPN Sensor with M8 Connector*	CP-2, -3, -4	OISN-011	1-2
Inductive PNP Sensor with M12 Connector*	CP-5, -6	OISP-017	1-2
Inductive NPN Sensor with M12 Connector*	CP-5, -6	OISN-017	1-2
M8 Quick Disconnect 2 Meter Cable Length*	All Models	CABL-010	1-2
M12 Quick Disconnect 2 Meter Cable Length*	All Models	CABL-014	1-2

*Sensor and cable sold separately.

2-Jaw General Industrial Grippers | Technical Specifications

Specifications	Units	1	1-C	2	2-C	3	3-C
Total Rated Grip Force F @ 100 psi [7 bar] w/o Spring Assist	N [lbs]	89 [20]	60 [13]	238 [53]	161 [36]	677 [152]	407 [91]
Total Rated Grip Force F @ 100 psi [7 bar] with Spring Assist	N [lbs]	15 [3]	10 [2]	43 [10]	29 [7]	161 [36]	97 [22]
Total Stroke	mm [in]	4 [0.16]	6 [0.24]	6 [0.24]	9 [0.35]	10 [0.39]	16 [0.63]
Weight	kg [lbs]	0.09 [0.20]	0.09 [0.20]	0.21 [0.46]	0.20 [0.44]	0.45 [0.99]	0.47 [1.04]
Pressure Range w/o Spring	bar [psi]	2-10 [29-145]					
Pressure Range with Spring	bar [psi]	2.5-10 [36-145]					
Ingress Protection Class (IP)		IP54					
Displacement	cm ³ [in ³]	0.7 [0.04]		2.7 [0.16]		11.7 [0.71]	
Temperature Range	°C [°F]	-35°~80° [-30°~180°]					
Actuation (open/close)	sec	0.06				0.07	
Repeatability	mm [in]	±0.025 [±0.001]					
Valve to Actuate Single Acting		3-way, 2-position					
Valve to Actuate Double Acting		4-way, 2-position					

Specifications	Units	4	4-C	5	5-C	6	6-C
Total Rated Grip Force F @ 100 psi [7 bar] w/o Spring Assist	N [lbs]	1016 [228]	665 [149]	1591 [358]	1081 [243]	2749 [618]	2092 [470]
Total Rated Grip Force F @ 100 psi [7 bar] with Spring Assist	N [lbs]	222 [50]	145 [33]	322 [72]	219 [49]	711 [160]	541 [122]
Total Stroke	mm [in]	13 [0.51]	20 [0.79]	18 [0.71]	27 [1.06]	24 [0.94]	32 [1.26]
Weight	kg [lbs]	0.73 [1.61]	0.75 [1.65]	1.25 [2.76]	1.27 [2.80]	2.5 [5.51]	2.56 [5.64]
Pressure Range w/o Spring	bar [psi]	2-10 [29-145]					
Pressure Range with Spring	bar [psi]	2.5-10 [36-145]					
Ingress Protection Class (IP)		IP54					
Displacement	cm ³ [in ³]	24.2 [1.48]		53.5 [3.26]		114.8 [7.01]	
Temperature Range	°C [°F]	-35°~80° [-30°~180°]					
Actuation (open/close)	sec	0.07		0.09		0.12	
Repeatability	mm [in]	±0.025 [±0.001]					
Valve to Actuate Single Acting		3-way, 2-position					
Valve to Actuate Double Acting		4-way, 2-position					

CP-1, CP-1-C

2-Jaw General Industrial Grippers | Dimensions and Technical Specifications

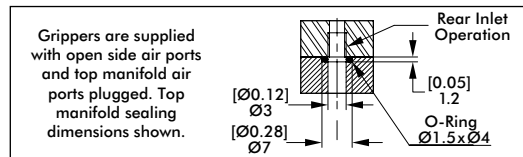
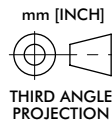
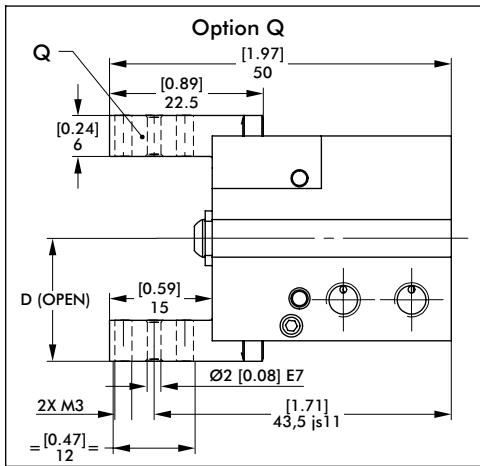
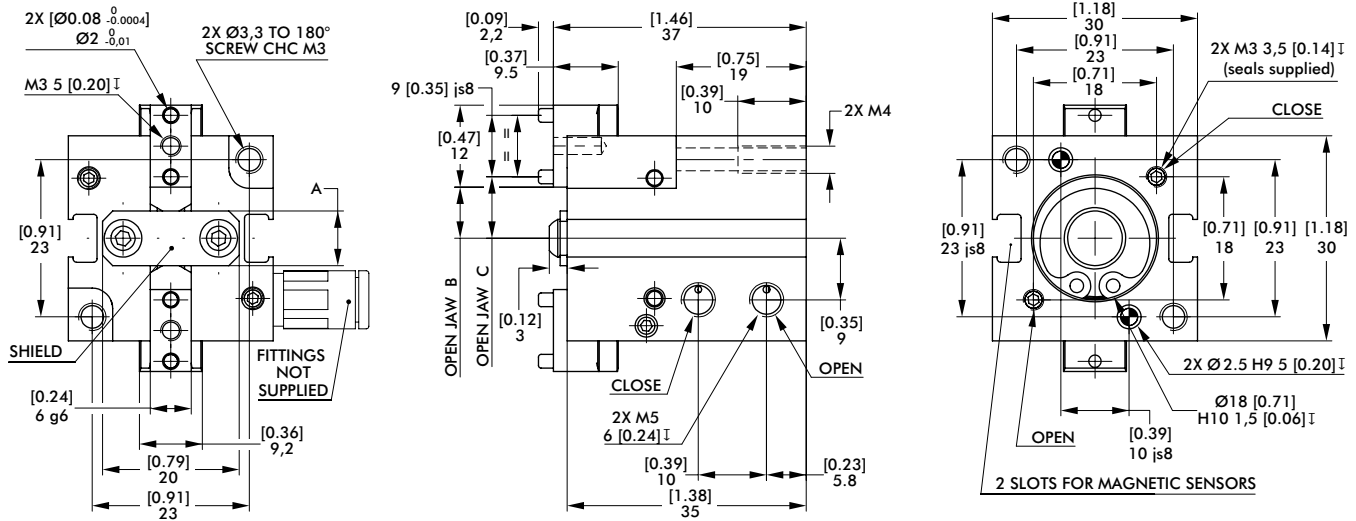

Seal Repair Kits	Buna-N	Viton®
Seal Repair Kit	SCP1	SCP1V
Repair Kit (screws, springs, seals)	KSCP1	KSCP1V

Model	A	B	C	D
CP-1	6 [0.24]	5.3 [0.21]	6.8 [0.27]	15.8 [0.62]
CP-1-C	8 [0.31]	7.5 [0.30]	9 [0.35]	18 [0.71]

Dimensions in mm [in]

Loading Information

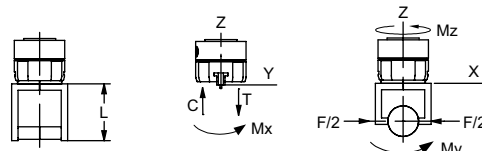
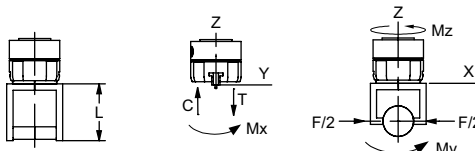
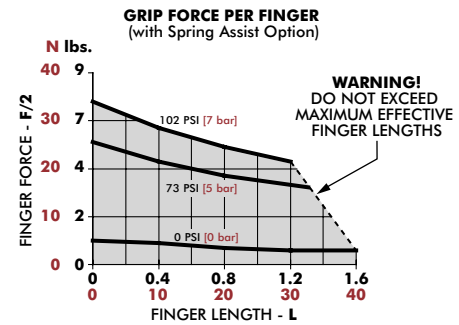
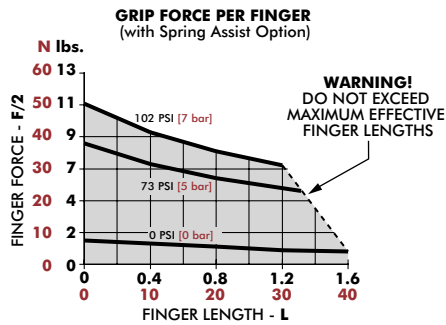

CP-1	Static	Dynamic
Maximum Tensile T	110 N [25 lbs]	10 N [2 lbs]
Maximum Compressive C	190 N [43 lbs]	10 N [2 lbs]
Maximum Moment M_x	1 Nm [9 in-lbs]	0.2 Nm [2 in-lbs]
Maximum Moment M_y	2 Nm [18 in-lbs]	0.4 Nm [4 in-lbs]
Maximum Moment M_z	2 Nm [18 in-lbs]	0.4 Nm [4 in-lbs]

*Capacities are per set of jaws and are not simultaneous

CP-1-C	Static	Dynamic
Maximum Tensile T	110 N [25 lbs]	8 N [2 lbs]
Maximum Compressive C	190 N [43 lbs]	8 N [2 lbs]
Maximum Moment M_x	1 Nm [9 in-lbs]	0.2 Nm [2 in-lbs]
Maximum Moment M_y	2 Nm [18 in-lbs]	0.3 Nm [3 in-lbs]
Maximum Moment M_z	2 Nm [18 in-lbs]	0.3 Nm [3 in-lbs]

*Capacities are per set of jaws and are not simultaneous

2-Jaw General Industrial Grippers | Dimensions and Technical Specifications

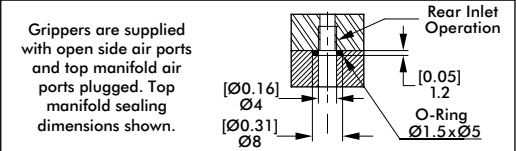
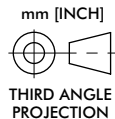
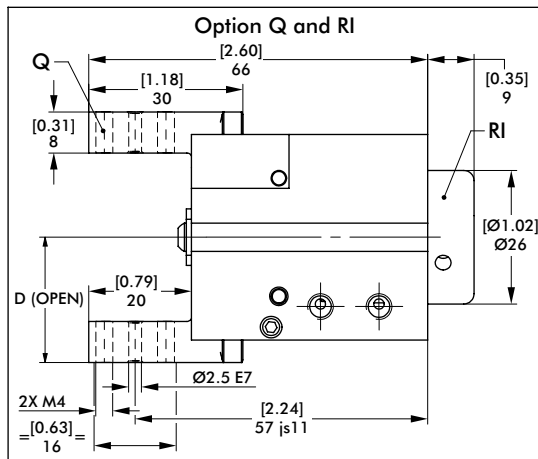
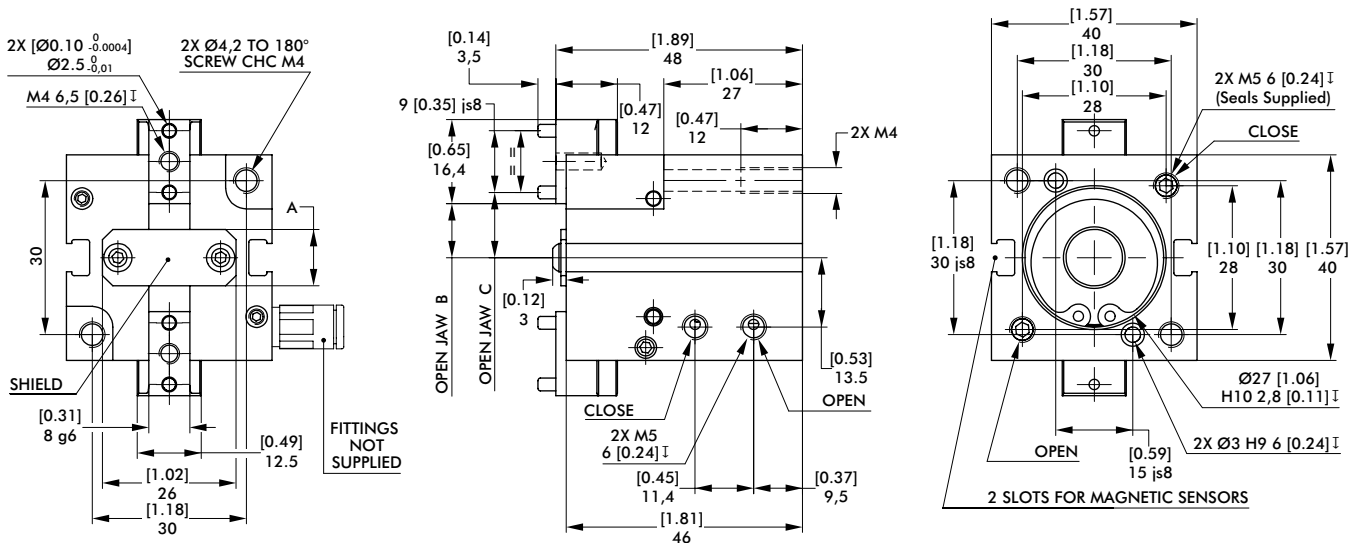

Sensor Accessories		CP-2
Inductive Sensor Mounting Kit (mounts 2 sensors) (SD)		SDCP2

Seal Repair Kits	Buna-N	Viton®
Seal Repair Kit	SCP2	SCP2V
Repair Kit (screws, springs, seals)	KSCP2	KSCP2V

Model	A	B	C	D
CP-2	7,5 [0.30]	7,1 [0.28]	9,3 [0.37]	21 [0.83]
CP-2-C	11 [0.43]	10,5 [0.41]	12,7 [0.50]	24,4 [0.96]

Dimensions in mm [in]

Loading Information

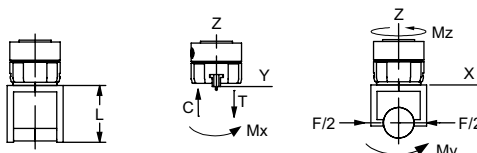
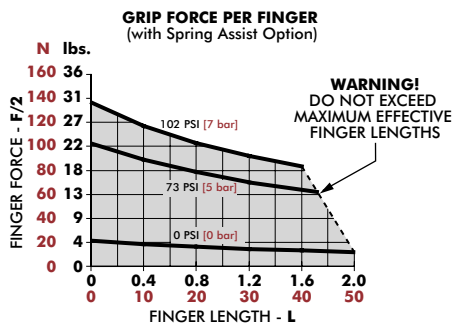

CP-2	Static	Dynamic
Maximum Tensile T	260 N [58 lbs]	26 N [6 lbs]
Maximum Compressive C	375 N [84 lbs]	26 N [6 lbs]
Maximum Moment M_x	5 Nm [44 in-lbs]	0.9 Nm [8 in-lbs]
Maximum Moment M_y	8 Nm [71 in-lbs]	1.5 Nm [13 in-lbs]
Maximum Moment M_z	8 Nm [71 in-lbs]	1.5 Nm [13 in-lbs]

*Capacities are per set of jaws and are not simultaneous

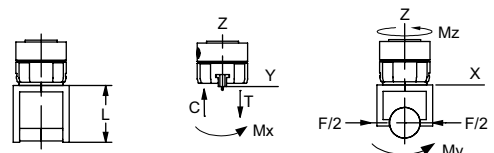
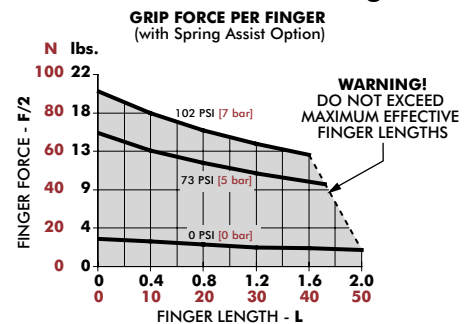

CP-2-C	Static	Dynamic
Maximum Tensile T	260 N [58 lbs]	22 N [5 lbs]
Maximum Compressive C	375 N [84 lbs]	22 N [5 lbs]
Maximum Moment M_x	4 Nm [35 in-lbs]	0.7 Nm [6 in-lbs]
Maximum Moment M_y	8 Nm [71 in-lbs]	1.2 Nm [11 in-lbs]
Maximum Moment M_z	8 Nm [71 in-lbs]	1.2 Nm [11 in-lbs]

*Capacities are per set of jaws and are not simultaneous

CP-3, CP-3-C

2-Jaw General Industrial Grippers | Dimensions and Technical Specifications

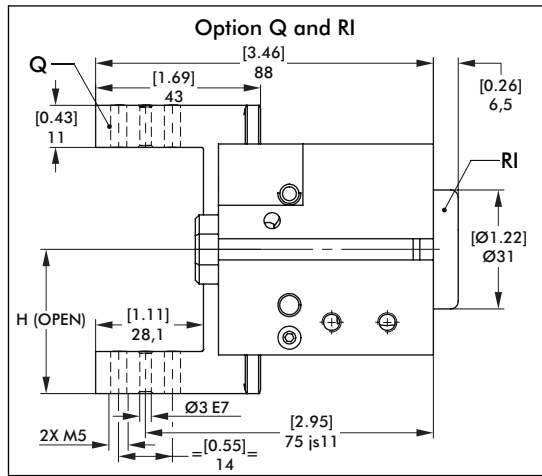
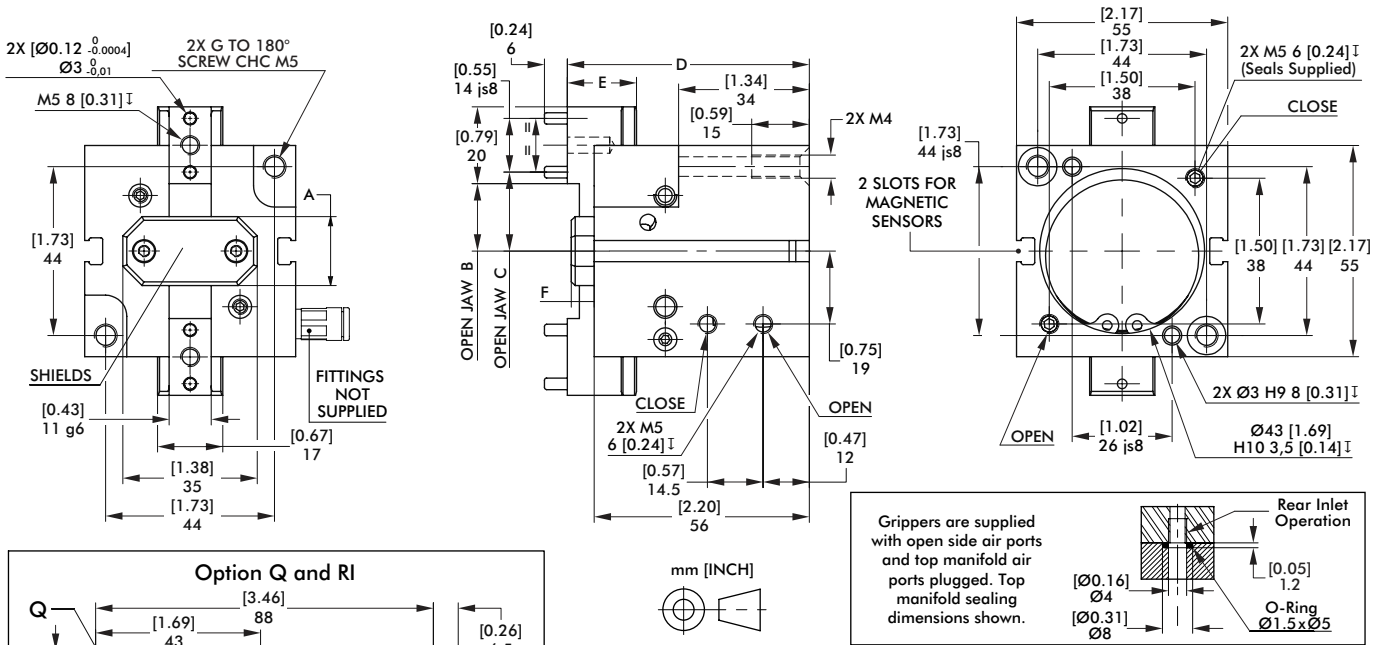

Sensor Accessories	CP-3
Inductive Sensor Mounting Kit (mounts 2 sensors) (SD)	SDCP3

Seal Repair Kits	Buna-N	Viton®
Seal Repair Kit	SCP3	SCP3V
Repair Kit (screws, springs, seals)	KSCP3	KSCP3V

Model	A	B	C	D	E
CP-3	12 [0.47]	12 [0.47]	15 [0.59]	58 [2.28]	13 [0.51]
CP-3-C	18 [0.71]	17.6 [0.69]	20.6 [0.81]	63 [2.48]	18 [0.71]

Model	F	G	H	J
CP-3	3 [0.12]	3.3 [0.13]	84 [3.31]	32 [1.26]
CP-3-C	6 [0.24]	5.1 [0.20]	88 [3.46]	37.6 [1.48]

Dimensions in mm [in]

Loading Information

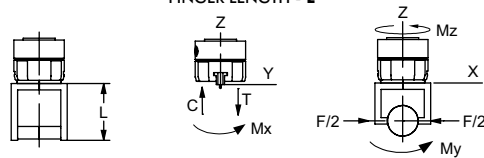
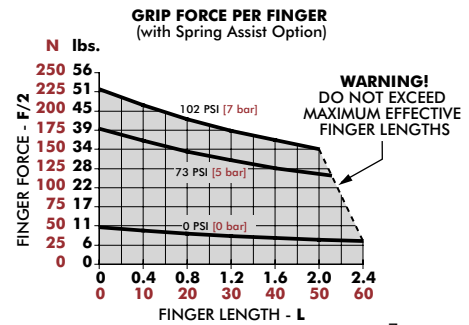
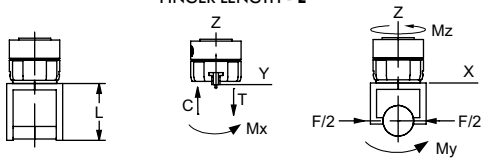
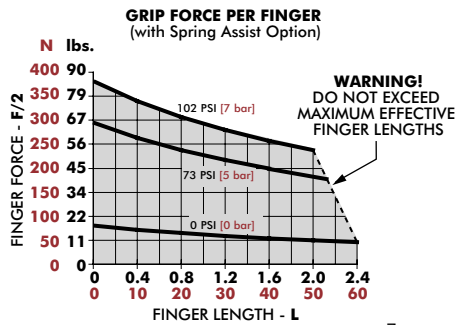

CP-3	Static	Dynamic
Maximum Tensile T	520 N [117 lbs]	72 N [16 lbs]
Maximum Compressive C	690 N [155 lbs]	72 N [16 lbs]
Maximum Moment M _x	11 Nm [97 in-lbs]	3.5 Nm [31 in-lbs]
Maximum Moment M _y	18 Nm [159 in-lbs]	6 Nm [53 in-lbs]
Maximum Moment M _z	17 Nm [150 in-lbs]	6 Nm [53 in-lbs]

[†]Capacities are per set of jaws and are not simultaneous

CP-3-C	Static	Dynamic
Maximum Tensile T	500 N [112 lbs]	55 N [12 lbs]
Maximum Compressive C	675 N [152 lbs]	55 N [12 lbs]
Maximum Moment M _x	9 Nm [80 in-lbs]	2.5 Nm [22 in-lbs]
Maximum Moment M _y	16 Nm [142 in-lbs]	4 Nm [35 in-lbs]
Maximum Moment M _z	17 Nm [150 in-lbs]	4 Nm [35 in-lbs]

[†]Capacities are per set of jaws and are not simultaneous

2-Jaw General Industrial Grippers | Dimensions and Technical Specifications

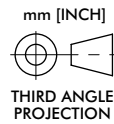
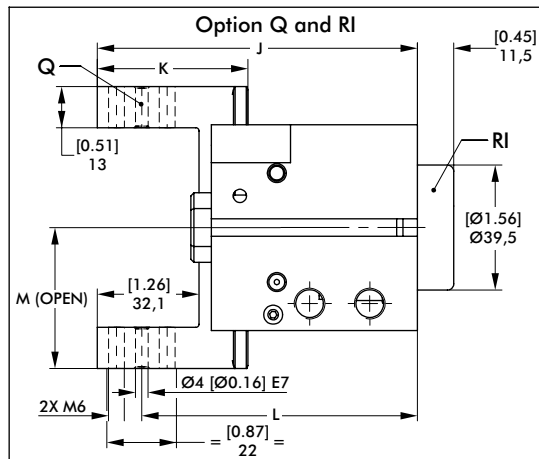
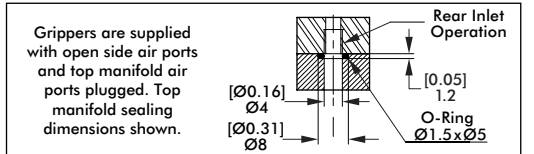
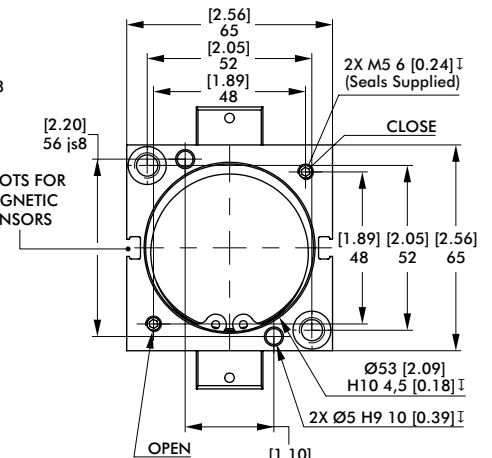
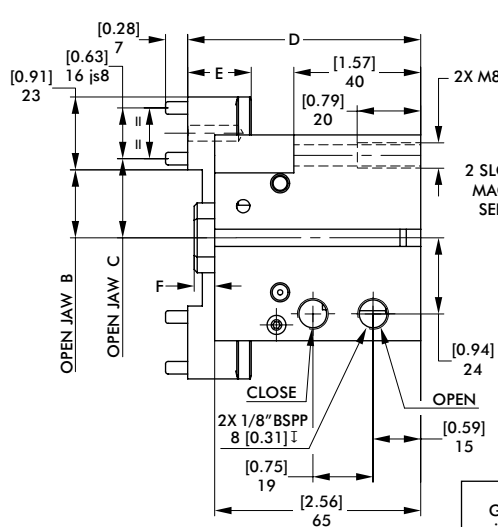
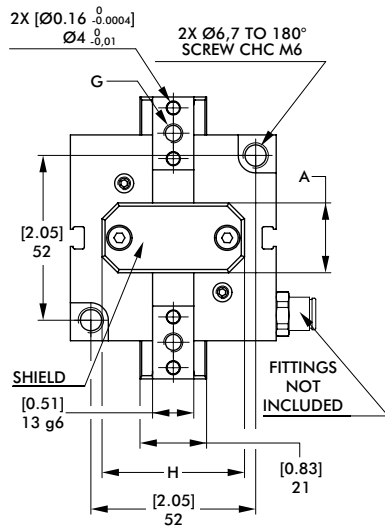

Sensor Accessories

Inductive Sensor Mounting Kit (mounts 2 sensors) (SD) **CP-4** SDCP4

Seal Repair Kits

Seal Repair Kit **Buna-N** SCP4 **Viton®** SCP4V

Repair Kit (screws, springs, seals) **KSCP4** KSCP4V

Model	A	B	C	D	E	F
CP-4	16 [0.63]	16 [0.63]	19.5 [0.77]	73 [2.87]	19.5 [0.77]	3 [0.12]
CP-4-C	22 [0.87]	21.5 [0.85]	25 [0.98]	73.5 [2.89]	20 [0.79]	6.5 [0.26]

Model	G	H	J	K	L	M
CP-4	M5 8 [0.31]	46 [1.81]	97 [3.82]	43.5 [1.71]	83 [3.27]	39 [1.54]
CP-4-C	M6 12 [0.47]	45 [1.77]	101 [3.98]	47.5 [1.87]	87 [3.43]	44.5 [1.75]

Dimensions in mm [in]

Loading Information

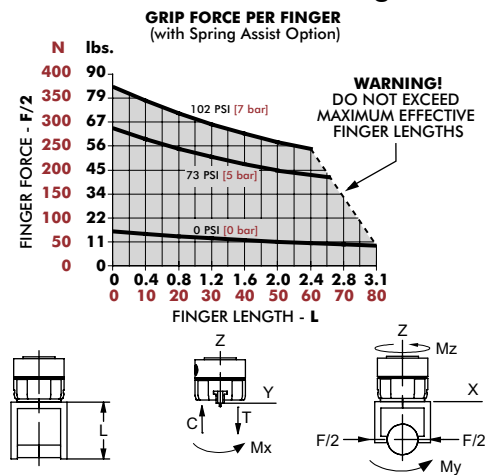
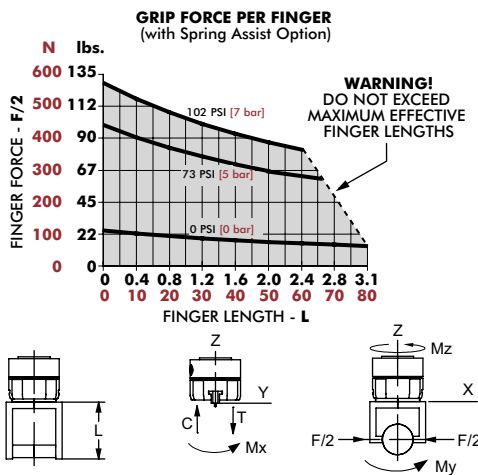

CP-4	Static	Dynamic
Maximum Tensile T	740 N [166 lbs]	109 N [24 lbs]
Maximum Compressive C	830 N [187 lbs]	109 N [24 lbs]
Maximum Moment M_x	23 Nm [204 in-lbs]	6.5 Nm [58 in-lbs]
Maximum Moment M_y	35 Nm [310 in-lbs]	10 Nm [89 in-lbs]
Maximum Moment M_z	25 Nm [221 in-lbs]	8 Nm [71 in-lbs]

Capacities are per set of jaws and are not simultaneous

CP-4-C	Static	Dynamic
Maximum Tensile T	710 N [160 lbs]	89 N [20 lbs]
Maximum Compressive C	800 N [180 lbs]	89 N [20 lbs]
Maximum Moment M_x	18 Nm [159 in-lbs]	4.7 Nm [42 in-lbs]
Maximum Moment M_y	30 Nm [266 in-lbs]	7.6 Nm [67 in-lbs]
Maximum Moment M_z	25 Nm [221 in-lbs]	7.6 Nm [67 in-lbs]

Capacities are per set of jaws and are not simultaneous

CP-5, CP-5-C

2-Jaw General Industrial Grippers | Dimensions and Technical Specifications

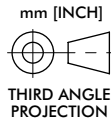
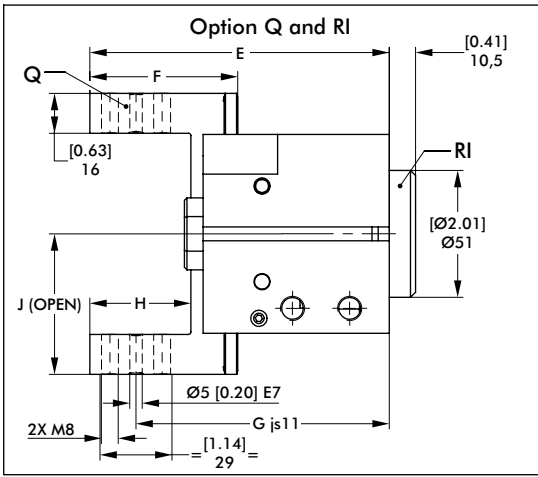
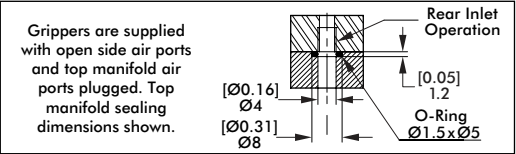
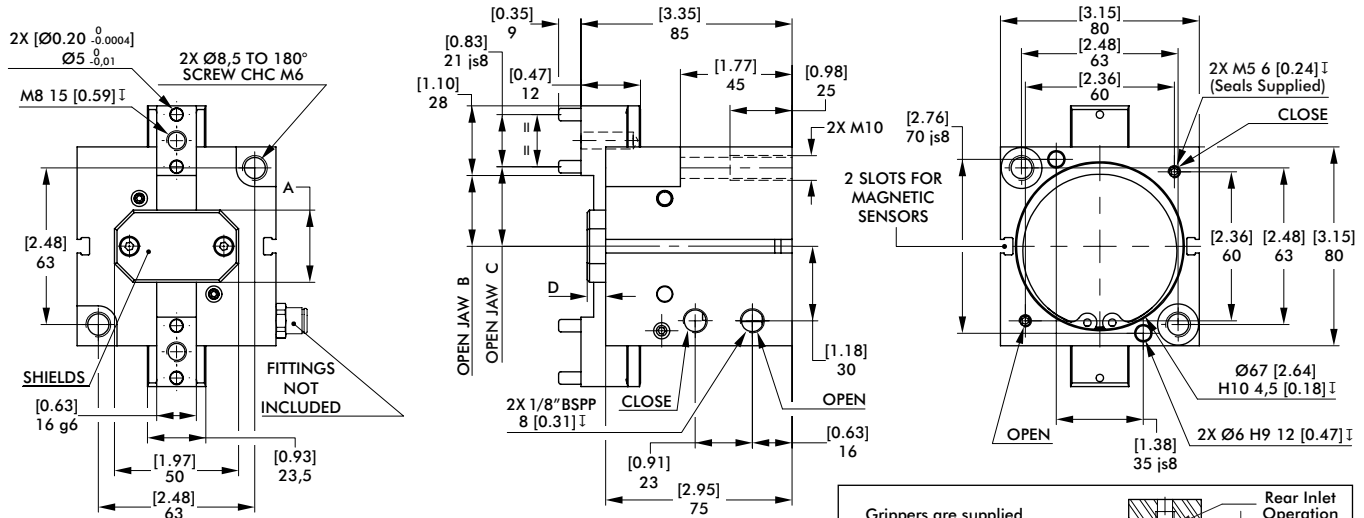

Sensor Accessories	CP-5
Inductive Sensor Mounting Kit (mounts 2 sensors) (SD)	SDCP5

Seal Repair Kits	Buna-N	Viton®
Seal Repair Kit	SCP5	SCP5V
Repair Kit (screws, springs, seals)	KSCP5	KSCP5V

Model	A	B	C	D	E
CP-5	20 [0.79]	19.5 [0.77]	23 [0.91]	3 [0.12]	115.5 [4.55]
CP-5-C	29 [1.14]	28.5 [1.12]	32 [1.26]	7.5 [0.30]	120.5 [4.74]

Model	F	G	H	J
CP-5	54.5 [2.15]	97 [3.82]	40.5 [1.59]	47.5 [1.87]
CP-5-C	59.5 [2.34]	102 [4.02]	40.6 [1.60]	56.5 [2.22]

Dimensions in mm [in]

Loading Information

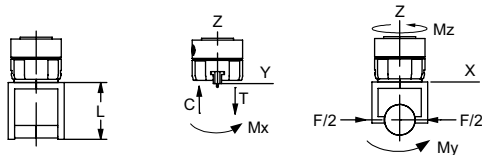
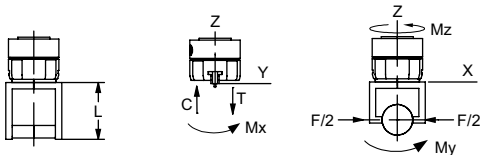
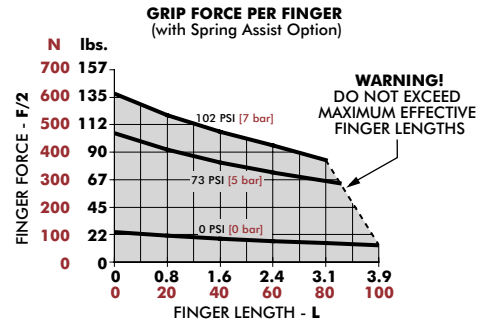
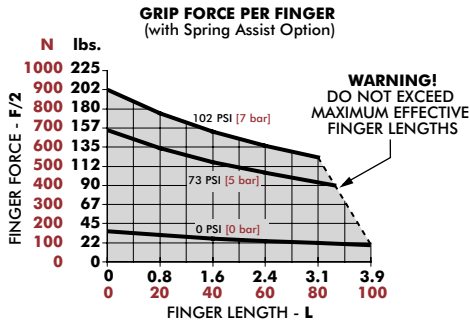

CP-5	Static	Dynamic
Maximum Tensile T	830 N [187 lbs]	169 N [38 lbs]
Maximum Compressive C	940 N [211 lbs]	169 N [38 lbs]
Maximum Moment M_x	27 Nm [6 in-lbs]	9 Nm [80 in-lbs]
Maximum Moment M_y	44 Nm [10 in-lbs]	14 Nm [124 in-lbs]
Maximum Moment M_z	30 Nm [7 in-lbs]	10 Nm [89 in-lbs]

*Capacities are per set of jaws and are not simultaneous

CP-5-C	Static	Dynamic
Maximum Tensile T	820 N [184 lbs]	144 N [32 lbs]
Maximum Compressive C	930 N [209 lbs]	144 N [32 lbs]
Maximum Moment M_x	22 Nm [195 in-lbs]	7 Nm [62 in-lbs]
Maximum Moment M_y	40 Nm [354 in-lbs]	13 Nm [115 in-lbs]
Maximum Moment M_z	30 Nm [266 in-lbs]	10 Nm [89 in-lbs]

*Capacities are per set of jaws and are not simultaneous

2-Jaw General Industrial Grippers | Dimensions and Technical Specifications

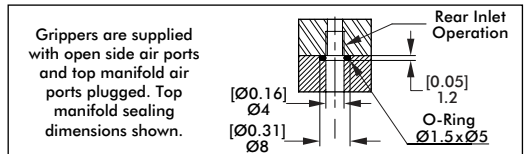
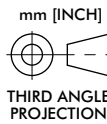
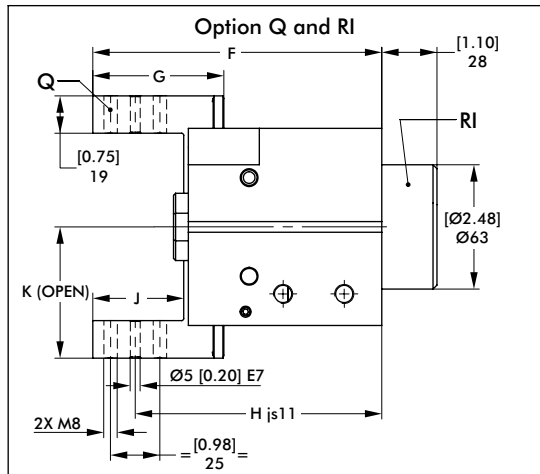
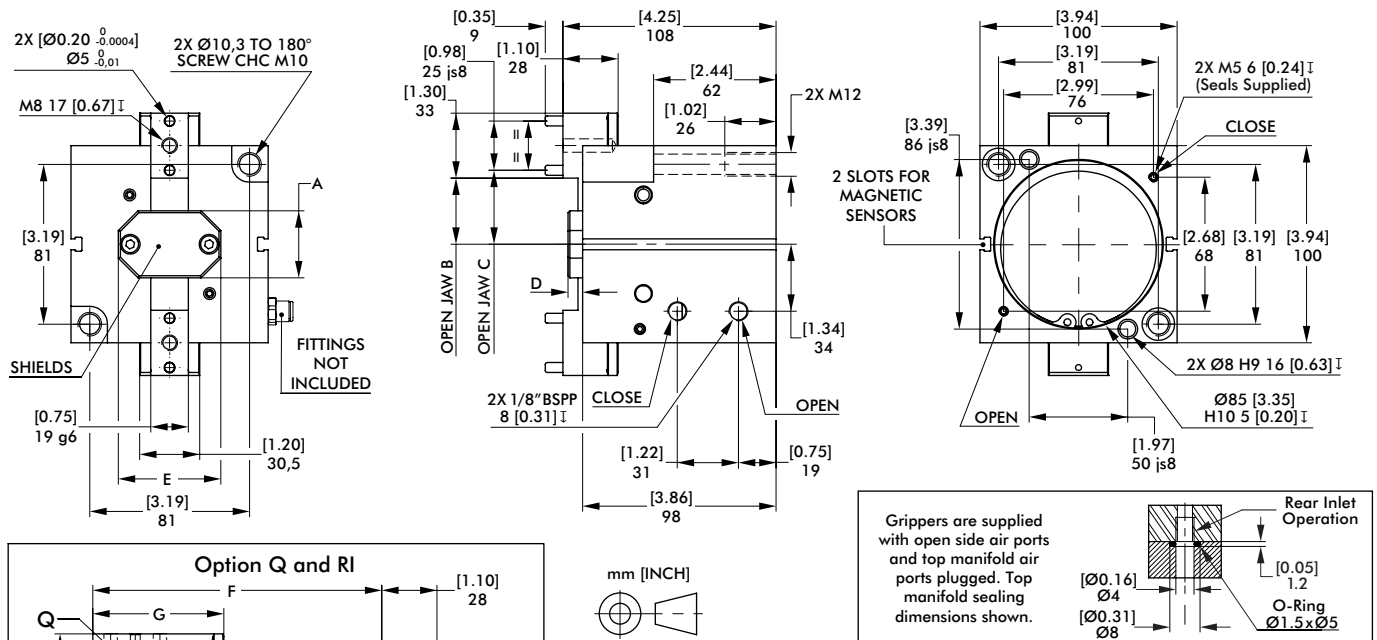

Sensor Accessories		CP-6
Inductive Sensor Mounting Kit (mounts 2 sensors) (SD)		SDCP6

Seal Repair Kits		Buna-N	Viton®
Seal Repair Kit		SCP6	SCP6V
Repair Kit (screws, springs, seals)		KSCP6	KSCP6V

Model	A	B	C	D	E
CP-6	26 [1.02]	25,5 [1.00]	29,5 [1.16]	3 [0.12]	50 [1.97]
CP-6-C	34 [1.34]	33,5 [1.32]	37,5 [1.48]	7,5 [0.30]	52 [2.05]

Model	F	G	H	J	K
CP-6	144 [5.67]	64 [2.52]	122,5 [4.82]	46 [1.81]	58,5 [2.30]
CP-6-C	146,5 [5.77]	66,5 [2.62]	125 [4.92]	46,1 [1.81]	66,5 [2.62]

Dimensions in mm [in]

Loading Information

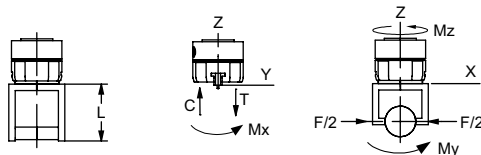
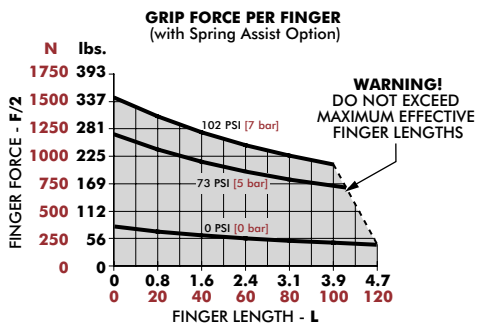

	Static	Dynamic
Maximum Tensile T	1375 N [309 lbs]	209 N [47 lbs]
Maximum Compressive C	1500 N [337 lbs]	209 N [47 lbs]
Maximum Moment M_x	48 Nm [11 in-lbs]	16 Nm [142 in-lbs]
Maximum Moment M_y	72 Nm [16 in-lbs]	24 Nm [212 in-lbs]
Maximum Moment M_z	68 Nm [15 in-lbs]	22 Nm [195 in-lbs]

†Capacities are per set of jaws and are not simultaneous

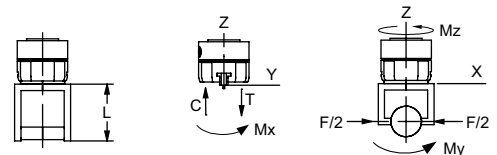
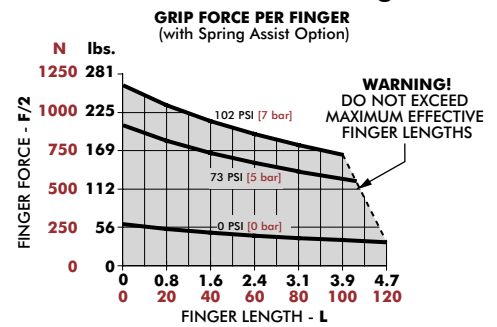

	Static	Dynamic
Maximum Tensile T	1340 N [301 lbs]	279 N [63 lbs]
Maximum Compressive C	1450 N [326 lbs]	279 N [63 lbs]
Maximum Moment M_x	42 Nm [372 in-lbs]	14 Nm [124 in-lbs]
Maximum Moment M_y	70 Nm [620 in-lbs]	23 Nm [204 in-lbs]
Maximum Moment M_z	64 Nm [566 in-lbs]	21 Nm [186 in-lbs]

†Capacities are per set of jaws and are not simultaneous