

TMR3109

23-bit TMR Magnetic Rotary Encoder

Description

The TMR3109 is a contactless, high-precision, and high-speed magnetic rotary encoder sensor, which integrated with tunneling magnetoresistance (TMR) sensors and CMOS digital signal processing circuitry.

The TMR3109 senses the single pole-pair magnet rotation above the chip by TMR sensors, collects the rotating magnetic field signal, transmits it to the digital processing unit, and calculates the rotation angle.

The TMR3109 supports 3-wire and 4-wire SPI working modes, allowing the client MCU to read 23-bit absolute position information through the SPI protocol.

Auto-calibration is available for the TMR3109 to compensate non-linearities caused by imperfect installation.

Features and Benefits

- Tunneling magnetoresistance (TMR) technology
- Supply voltage: 3.3 V to 5 V
- Supply current: 10 mA (typical)
- Supports 0° to 360° absolute angle detection
- On and off axis measurements
- Available in SPI interface
- Angular output delay < 2 μ s
- Angular repeatability < $\pm 0.05^\circ$
- Speeds up to 40,000 RPM
- Auto-calibration function
- Integrated automatic gain calibration function
- RoHS & REACH compliant

Applications

- Contactless angular position measurement
- Brushless motor position sensing
- Rotary speed sensing
- Close loop stepper system
- Servo encoder



SOP8

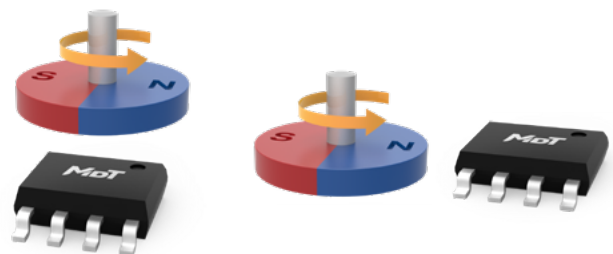

Selection Guide

Part Number (*)	Output Interface	Supply Voltage	Operating Temperature	Package	Packing Form
TMR3109P	SPI	3.3 V to 5 V	-40 °C to 125 °C	SOP8	Tape & Reel

Note: * Please contact MDT local sales representative for more model's information.

Catalogue

1. Pin Configuration	03
2. Functional Block Diagram	04
3. Absolute Maximum Ratings	05
4. Electrical Specifications	05
5. Digital Input Signals	05
6. Digital Output Signals	06
7. EEPROM Characteristics	06
8. Magnetic Field Specification	06
9. Output mode	07
9.1 SPI Output	07
10. Calibration	11
10.1 Factory Calibration	11
10.2 Auto-Calibration	11
10.3 Non-linear Calibration	12
11. Register List	13
12. Application Circuit Examples	13
13. Mechanical Angle Orientation	14
14. Dimensions	15

1. Pin Configuration

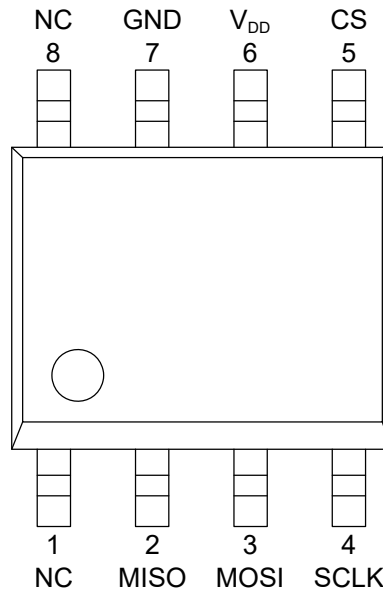

Figure 1. Pin configuration (SOP8)

Pin Number	Name	Input/Output	Signal type	Function
1	NC	-	-	Grounding recommended
2	MISO	Output	Digital	SPI data out
3	MOSI	Input	Digital	SPI data in
4	SCLK	Input	Digital	SPI clock
5	CS	Input	Digital	SPI chip select
6	V _{DD}	Input	Power supply	Power supply
7	GND	Input	Ground	Ground
8	NC	-	-	Grounding recommended

2. Functional Block Diagram

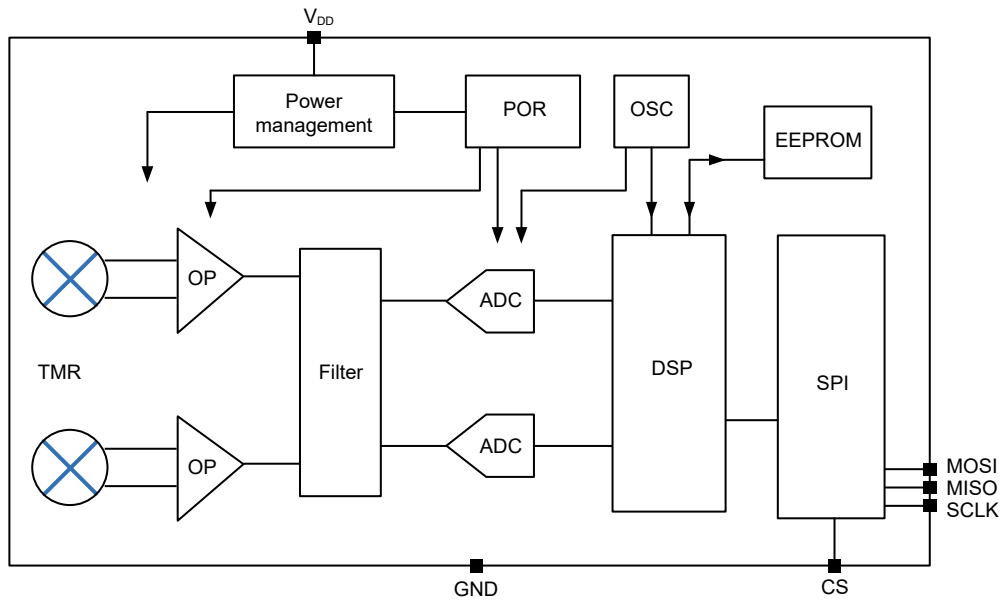

Figure 2. TMR3109 functional block diagram

3. Absolute Maximum Ratings

Parameter	Symbol	Min.	Max.	Unit
Supply voltage	V_{DD}	-0.3	6	V
Magnetic flux density	B	-	4000	Gs
A, B, Z, U, V, W, CS, SCLK, MISO, MOSI, PWM pin input voltage	V_{IN1}	-0.3	V_{DD}	V
A, B, Z, U, V, W, MISO pin output current	I_{OUT1}	-20	20	mA
Operating ambient temperature	T_A	-40	125	°C
Storage ambient temperature	T_{STG}	-40	150	°C
ESD performance (HBM)	V_{ESD}	-	4	kV

The absolute maximum rating only lists the conditions under which the sensors are not permanently damaged. For normal operations please refer to specifications.

4. Electrical Specifications

$T_A = 25\text{ °C}$ unless specified otherwise

Parameter	Symbol	Condition	Min.	Typ.	Max.	Unit
Supply voltage	V_{DD}	-	3.3	5.0	5.5	V
Supply current	I_{DD}	-	-	10	-	mA
Measurement range	A_{range}	-	0	-	360	Deg
Absolute resolution	RES_{SDC}	-	-	-	23	bit
Nonlinearity error	INL_{OPT}	-	-	± 0.05	-	Deg
Nonlinearity thermal drift	INL_{drift}	-40 °C to 125 °C	-	-	± 0.5	Deg
Repeatability	A_{repeat}	-	-	-	± 0.03	Deg
Output delay	T_D	-	-	2	-	μs
Rotation speed	R_{speed}	-	-	-	40000	RPM

5. Digital Input Signals

CS, SCLK, MOSI

Parameter	Symbol	Condition	Min.	Typ.	Max.	Unit
Input threshold high	$V_{I(HI)}$	-	$0.8 V_{DD}$	-	-	V
Input threshold low	$V_{I(LO)}$	-	-	-	$0.2 V_{DD}$	V

6. Digital Output Signals

MISO

Parameter	Symbol	Condition	Min.	Typ.	Max.	Unit
Output threshold high	$V_{O(HI)}$	$I = 1 \text{ mA}$	$V_{DD} - 0.3$	-	-	V
Output threshold low	$V_{O(LO)}$	$I = 1 \text{ mA}$	-	-	0.3	V
Rise time	t_{rise}	$C_L = 100 \text{ pF}$	-	-	100	ns
Fall time	t_{fall}	$C_L = 100 \text{ pF}$	-	-	100	ns
Output load capacitance	C_L	-	-	-	100	pF

7. EEPROM Characteristics

Parameter	Symbol	Condition	Min.	Typ.	Max.	Unit
MTP read/write supply voltage	V_{MTPW}	-	-	V_{DD}	-	V
EEPROM read/write cycles	E_{EN}	-	1000	-	-	Cycle
Data storage time	E_{RE}	-	10	-	-	Year

8. Magnetic Field Specification

Recommended magnet: cylindrical NdFeB magnet (N35SH), $\phi 9 \text{ mm} \times 2.5 \text{ mm}$, radial magnetization

Parameter	Symbol	Condition	Min.	Typ.	Max.	Unit
Diameter of magnet	d_{mag}	-	6	9	20	mm
Thickness of magnet	t_{mag}	-	-	2.5	-	mm
Mounting distance	D_{in}	Recommend magnet ($\phi 9 \text{ mm}$)	1	3	10	mm
Magnetic field	H_{ext}	Sensor surface	100	-	1000	Gs
Center deviation between magnet and sensor	x_{dis}	-	-	-	0.5	mm
Angle deviation of the sensor within package	ϕ_{pac}	-	-3	-	3	Deg

9. Output mode

9.1 SPI Output

9.1.1 SPI Sequence Diagram

TMR3109 provides the 4-wire SPI interface for user programming in common mode 1 (CPOL=0, CPHA=1). Data communication is only enabled when the CS pin is set to LOW. The MOSI pin carries the serial input data that will be written to the IC upon the falling edge of the SCLK signal. The serial output data is available to read at the MISO pin upon the rising edge of the SCLK signal.

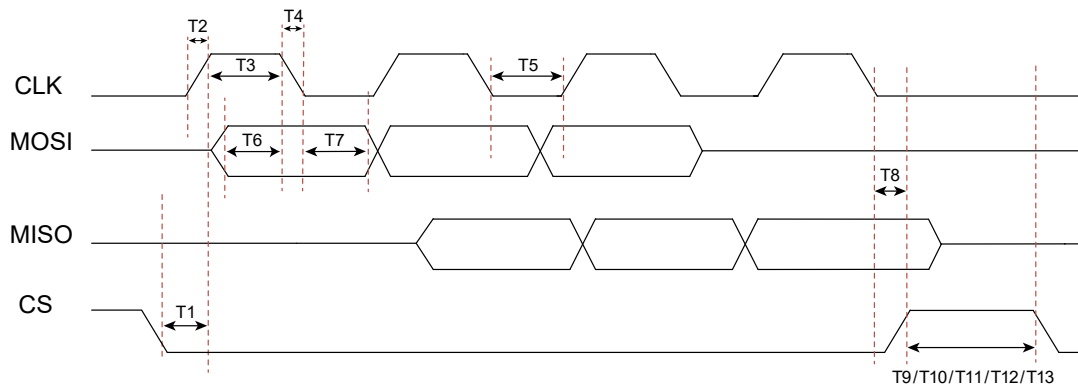

Figure 3. SPI timing diagram

Signal	Definition	Min.	Typ.	Max.	Unit
T1	SPI start-up time	-	100	-	ns
T2/T4	Clock signal rising/falling time	10	-	-	ns
T3	Clock signal HIGH period	40	-	-	ns
T5	Clock signal LOW period	40	-	-	ns
T6	Input signal setup time	30	-	-	ns
T7	Input signal sampling hold time	30	-	-	ns
T8	SPI closing time	-	50	-	ns
T9	SPI reading interval	1	-	-	μs
T10	EEPROM input interval	1000	-	-	ms
T11	Time interval between writing register, reading register, and reading EEPROM	2	-	-	ms
T12	Mode switching interval (normal to user mode)	2	-	-	ms
T13	Mode switching interval (user to normal mode)	5	-	-	ms

9.1.2 SPI Protocol

TMR3109 provides the 4-wire SPI interface for user programming in common mode 1 (CPOL=0, CPHA=1). Data communication is only enabled when the CS pin is set to LOW. The MOSI pin carries the serial input data that will be written to the IC upon the falling edge of the SCLK signal. The serial output data is available to read at the MISO pin upon the rising edge of the SCLK signal.

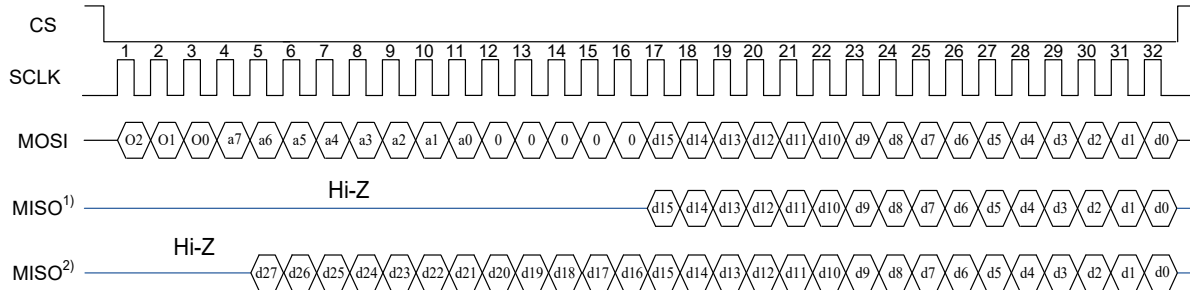

Figure 4. SPI data output sequence diagram

A complete SPI data transmission protocol, as shown in Figure 4, starts with the falling edge of CS and ends at the rising edge of CS. SCLK consists of 32 SPI serial clock pulses, controlled by the SPI master. When there is no SPI communication, CS is defaulted to high level, and SCLK to low level. MOSI and MISO are the input and output of SPI serial data, respectively. When SPI is not in output mode, MISO remains in "HI-Z" mode.

- CS: Low level during SPI communication, default high level when not communicating.
- SCLK: Consists of 32 clock pulses.
- MOSI: Consists of a 3-bit Op_code, 8-bit address, 5-bit idle, and 16-bit data.
- MISO: MISO¹⁾ When MISO outputs register data, it consists of 16-bit data.
MISO²⁾ When MISO is in angle output mode, it consists of 28-bit data.

Op_code	Definition
001	Write_ee
101	Write_register
110	Read_register
111	Change_mode
011	Read_angle

9.1.3 SPI Write EEPROM

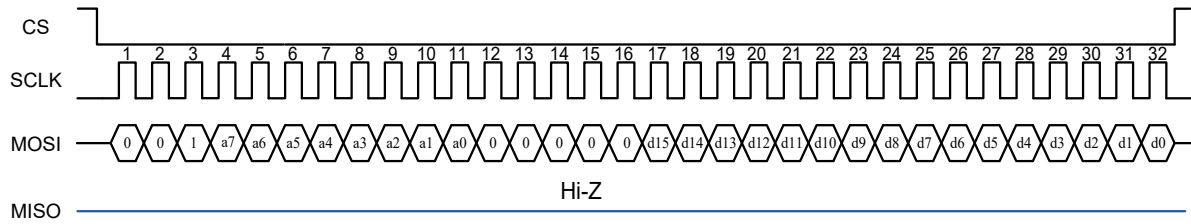

Figure 5. SPI write EEPROM sequence diagram

When writing EEPROM through SPI operation, the Op_code is: 3'b001. This corresponds to the EEPROM address from high to low corresponding to a7~a0, and the corresponding EEPROM data from high to low corresponding to d15~d0. After the operation is completed, wait at least 1000 ms before performing other actions.

9.1.4 SPI Write Register

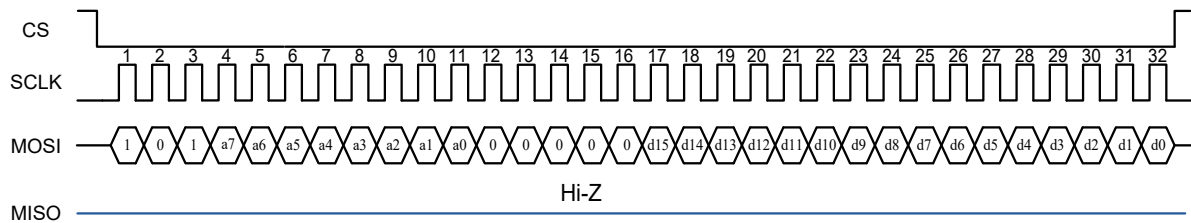

Figure 6. SPI write register sequence diagram

When writing register through SPI operation, the Op_code is: 3'b101. This corresponds to the register address from high to low corresponding to a7~a0, and the corresponding register data from high to low corresponding to d15~d0. After the operation is completed, wait at least 2 ms before performing other actions.

9.1.5 SPI Read Register

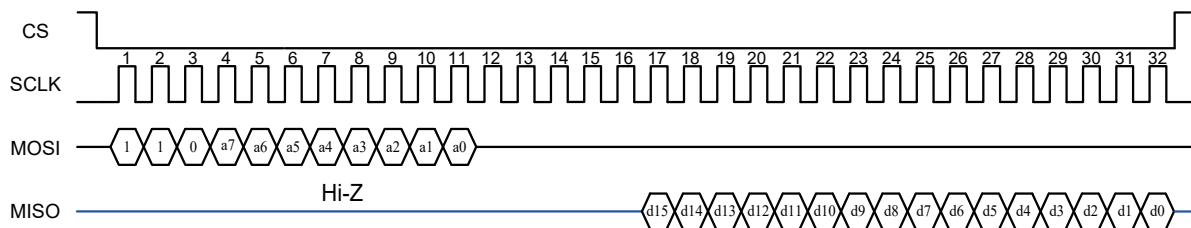

Figure 7. SPI write register sequence diagram

When reading register through SPI operation, the Op_code is: 3'b110, corresponding the register address from high to low from a7~a0. After the operation is completed, wait at least 2 ms before performing other actions.

9.1.6 SPI Mode Change (Normal mode to user mode)

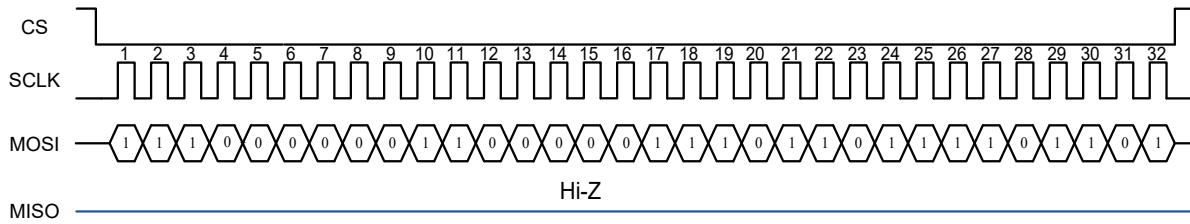

Figure 8. Normal mode to user mode change sequence diagram

When changing from normal mode to user mode through SPI operation, the Op_code is 3'b111. The matching register address is 8'b0000_0011 (8'h03), corresponding to register data 16'b1110_1101_1110_1101(16'headed). After successfully entering user mode from normal mode, wait at least 2 ms before performing other actions.

9.1.7 SPI Mode Change (User mode to normal mode)

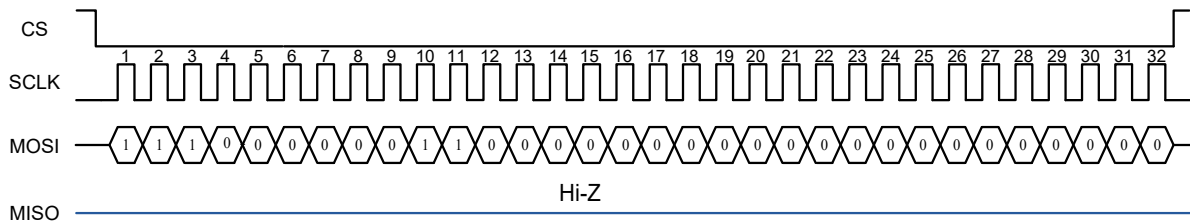

Figure 9. User mode to normal mode change sequence diagram

When returning from user mode to normal mode through SPI operation, the Op_code is 3'b111. The matching register address is 8'b0000_0011 (8'h03), corresponding to register data 16'b1110_1101_1110_1101(16'headed). Operate once to return from user mode to normal mode. Wait at least 5ms before performing other actions.

9.1.8 SPI Read Angle

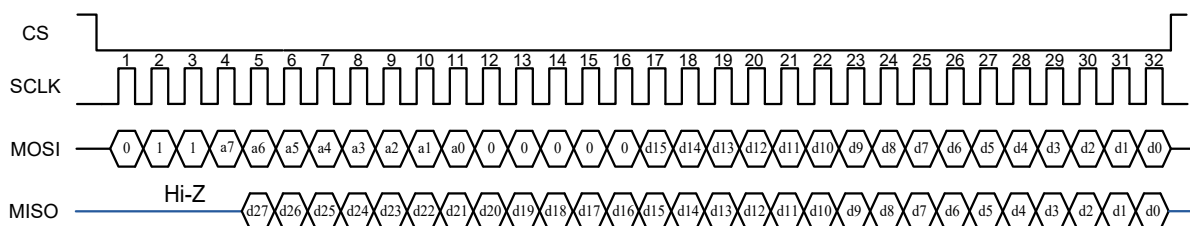

Figure 10. SPI read angle sequence diagram

When reading angle through SPI, the Op_code is 3'b011. d27~d5 corresponds to angle value; d4~d1 is the angle value corresponding to CRC code; d0 is error. Wait at least 2 μs before performing other actions.

1) d[27:5]: 23-bit angle data. The absolute angle value θ between 0 to 360° may be calculated by:

$$\theta = \frac{\sum_{i=0}^{22} \text{Angle} \langle i \rangle \times 2^i}{8388608} \times 360^\circ$$

2) d[4:1]: 4-bit CRC code. The CRC range is 1-bit "0" followed by 23-bit angle value (24-bit data in total). CRC polynomial is $x^4 + x^3 + x^2 + 1$, and the initial value is 4'b0101.

3) d0: error

10. Calibration

The TMR3109 offers two calibration modes, for different customer requirements, as shown in Figure 11. Customers can use built-in auto-calibration function or the 64-point non-linear calibration (LNR) function to achieve precise angle output. It is recommended to use a high-precision optical encoder when processing non-linear calibration (LNR).

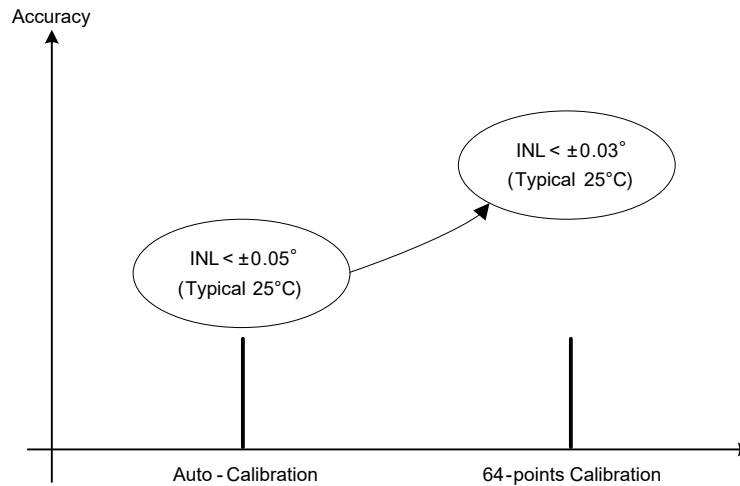

Figure 11. TMR3109 calibration options

10.1 Factory Calibration

Before delivery, MultiDimension Technology performs factory calibration on the TMR3109 to calibrate the original offset, gain mismatch and phase deviation of the angle sine/cosine signal. The original factory angular error is $< \pm 0.1^\circ$.

10.2 Auto-Calibration

MultiDimension Technology recommends users to calibrate the TMR3109 through the built-in auto-calibration function to maximize the encoder's performance in different applications and environments. Refer to procedures listed below to perform TMR3109 self-calibration. Install the TMR3109 in on-axis position as shown in Figure 12. Run the motor at constant speed¹⁾. Initiate auto-calibration function through SPI²⁾. The TMR3109 will begin auto-calibration and calculate relevant compensation coefficients automatically. After 3 to 5 seconds, the TMR3109 will store the compensation coefficients in the EEPROM and indicate that auto-calibration is complete. The post auto-calibration angular error is $< \pm 0.05^\circ$.

Note:

- 1) The motor should run at constant speed between 300 RPM and 3000 RPM during auto-calibration. MDT recommends 600 RPM.
- 2) Please refer to TMR3109 application manual or request "xMR310x demo board" to configure the encoder.

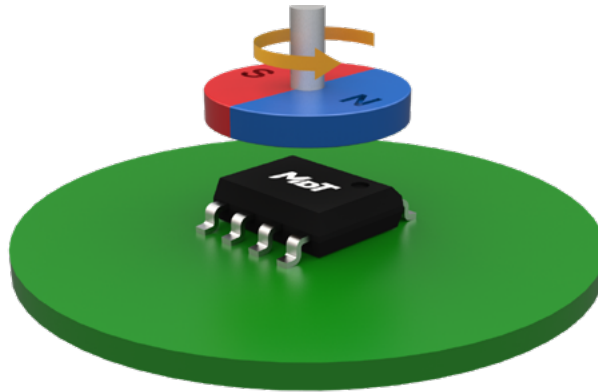

Figure 12. Self-calibration schematic

10.3 Non-linear Calibration

After self-calibration, the user may further improve the TMR3109 accuracy by performing 64-point non-linear calibration. Non-linear calibration is performed by comparing TMR3109 output to that of a high accuracy optical encoder.

1. Evenly divide 0 to 360° into 64 segments.
2. At each segment, read the TMR3109 SPI angle output and angle output of optical encoder.
3. Calculate the angular error for each segment by subtracting the TMR3109 angle output from the optical encoder angle output.
4. Store the error to `Inr_point0 [7:0] ~ Inr_point63 [7:0]` where `Inr_point0 [7:0] ~ Inr_point63 [7:0]` is the complement method and bit [7] is the sign bit.
5. Complete the non-linear calibration to yield better output.

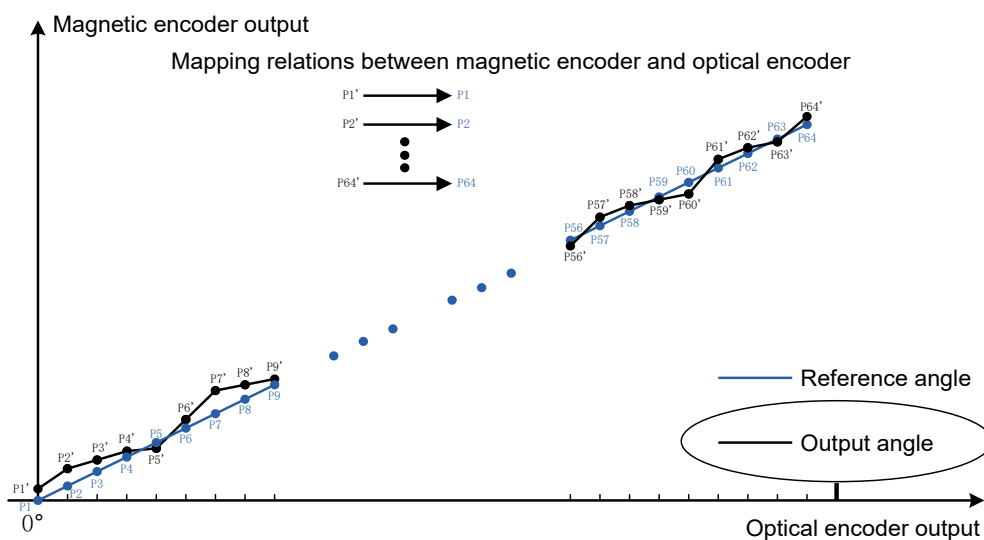

Figure 13. 64-point calibration illustration

11. Register List

Register Definition	Description
spi_zero [22:0]	SPI output zero setting
spi_hys [11:0]	SPI angle hysteresis
dis_error [1:0]	Enable error output
a_reverse	Reverse analog signal input
ccw/cw	Clockwise / counter-clockwise setting
backup id [15:0] chip id [15:0]	Customer programmable ID
Inr_point0 [7:0] ~ Inr_point63 [7:0]	64-point non-linear calibration coefficients

12. Application Circuit Examples

It is recommended to connect an external 100 nF decoupling capacitor between V_{DD} and GND close to the TMR3109 chip pins, and connect 500 Ω pull-up resistors for CS, SCLK, and MOSI. TMR3109 can be configured in 4-wire or 3-wire SPI mode and the connection method is shown in Figure 14 and Figure 15.

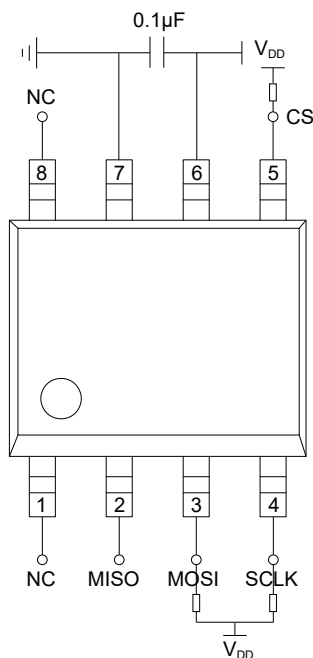

Figure 14. Schematic of 4-wire SPI circuit

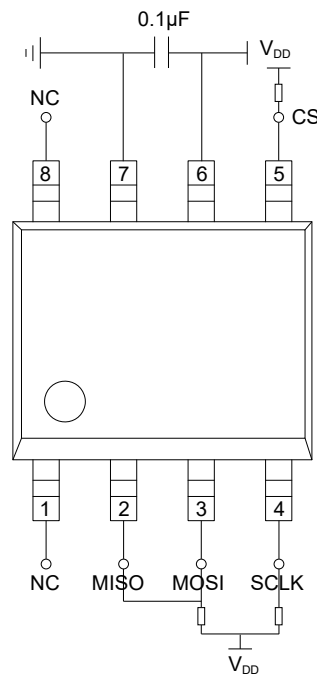

Figure 15. Schematic of 3-wire SPI circuit

13. Mechanical Angle Orientation

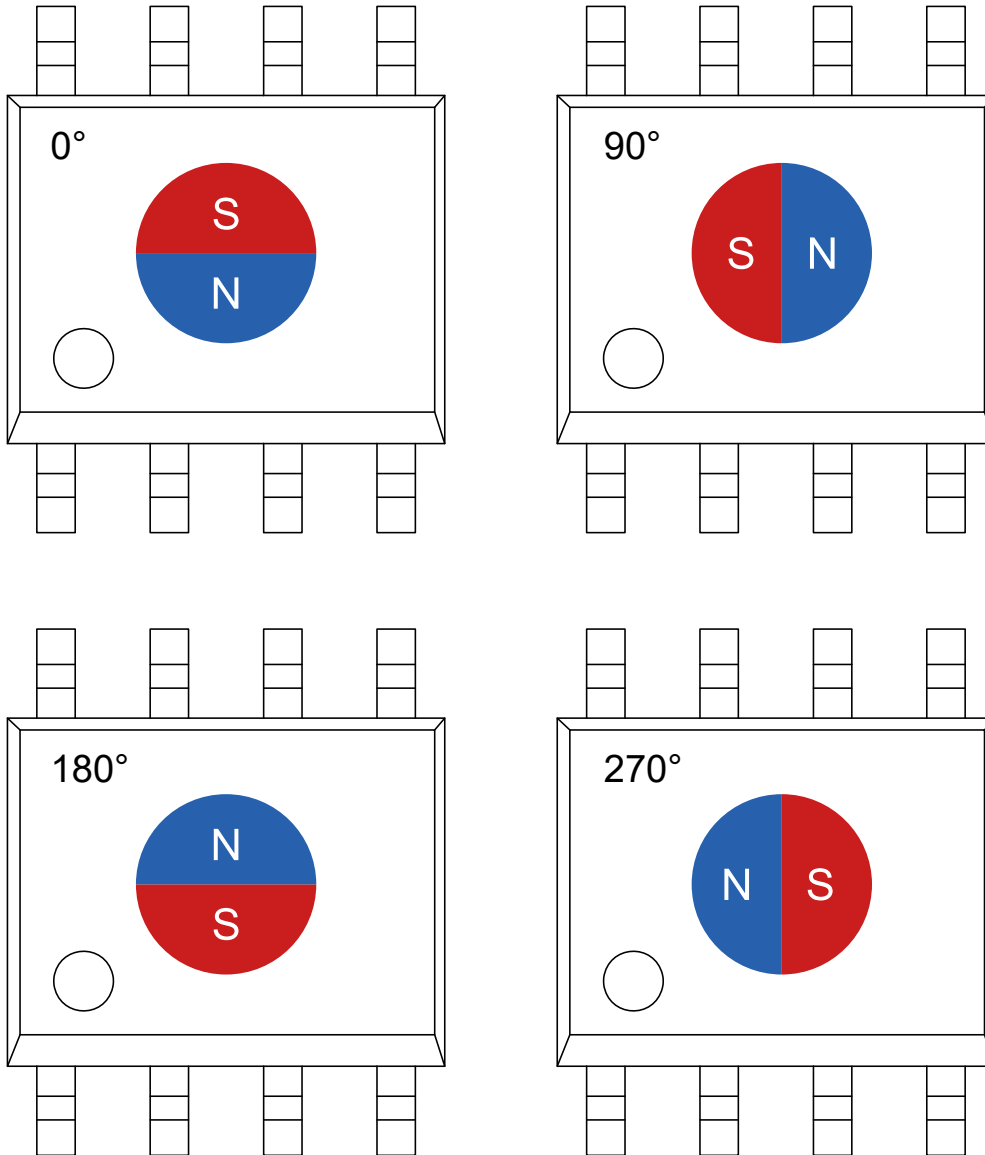

Figure 16. Definition of the magnetic field orientation measured by TMR3109

14. Dimensions

SOP8 Package

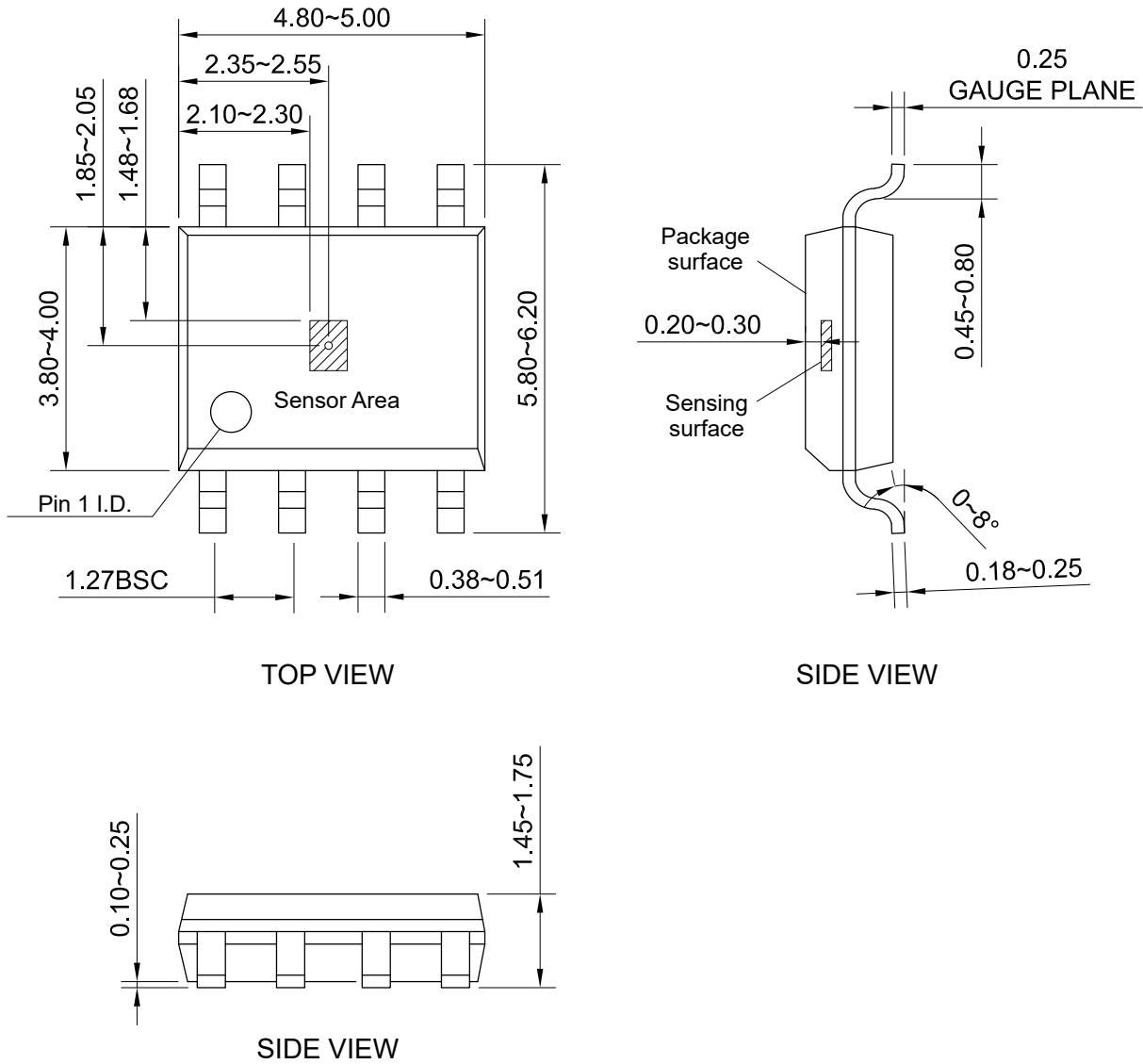

Figure 17. Package outline of SOP8 (unit: mm)

Copyright © 2024 by MultiDimension Technology Co., Ltd.

Information furnished herein by MultiDimension Technology Co., Ltd. (hereinafter MDT) is believed to be accurate and reliable. However, MDT disclaims any and all warranties and liabilities of any kind, with respect to any examples, hints or any performance or use of technical data as described herein and/or any information regarding the application of the product, including without limitation warranties of non-infringement of intellectual property rights of any third party. This document neither conveys nor implies any license under patent or other industrial or intellectual property rights. Customer or any third-party must further determine the suitability of the MDT products for its applications to avoid the applications default of customer or third-party. MDT accept no liability in this respect.

MDT does not assume any liabilities of any indirect, incidental, punitive, special or consequential damages (including without limitation of lost profits, lost savings, business interruption, costs related to the removal or replacement of any products or rework charges) whether or not such damages are based on tort (including negligence), warranty, breach of contract or any other legal theory. Notwithstanding any damages that customer might incur for any reason whatsoever, MDT's aggregate and cumulative liability towards customer for the products described herein shall be limited in accordance with the terms and conditions of commercial sale of MDT.

Absolute maximum ratings are the extreme limits the device will withstand without damage to the MDT product. However, the electrical and mechanical characteristics are not guaranteed as the maximum limits (above recommended operating conditions) are approached. MDT disclaims any and all warranties and liabilities of the MDT product will operate at absolute maximum ratings.

Specifications may change without notice.

Please download latest document from our official website www.dowaytech.com/en.

Recycling

The product(s) in this document need to be handed over to a qualified solid waste management services company for recycling in accordance with relevant regulations on waste classification after the end of the product(s) life.



No.2 Guangdong Road, Zhangjiagang Free Trade Zone, Jiangsu, China

Web: www.dowaytech.com/en E-mail: info@dowaytech.com

