



PRODUCT SPECIFICATION

PUBLICATION DATE: 08/08/2022

PART NUMBER: HDA430-2S-IPS

| |
|-------------------|
| CUSTOMER APPROVAL |
|-------------------|

| |
|------------------------|
| PREPARED BY: Harry Woo |
|------------------------|

Hantronix, Inc.
10080 Bubb Road
Cupertino, CA 95014
Telephone: (408) 252-1100
Email: info@hantronix.com
Website: www.hantronix.com

1. General Specifications

| No. | Item | Contents | Unit |
|-----|---------------------|-----------------------------------|------|
| 1 | Size | 4.3 | inch |
| 2 | Resolution | 480RGB*272 | |
| 3 | Interface | RGB | |
| 4 | Color Depth | 16.7 | M |
| 5 | Technology Type | a-Si | |
| 6 | Pixel Pitch | 0.198*0.198 | mm |
| 7 | Pixel Arrangement | R.G.B Vertical Stripe | |
| 8 | Display Mode | Normally Black, Transmissive, IPS | |
| 9 | Viewing Direction | ALL | |
| 10 | LCM (W x H x D) | 105.50*67.20*3.01 | mm |
| 11 | Active Area (W x H) | 95.04*53.856 | mm |
| 12 | With/Without TSP | Without TSP | |
| 13 | LED Numbers | 12 | |

3. PIN Assignment

| Pin No. | Symbol | I/O | Function | Remark | | | | | | |
|---------|---------------------|-----|---|----------------------|----------------------|---|--------------|---|---------------------|--|
| 1 | LEDK | P | LED backlight cathode. | | | | | | | |
| 2 | LEDA | P | LED backlight anode. | | | | | | | |
| 3 | GND | P | Ground. | | | | | | | |
| 4 | VDD | P | Power supply for analog circuit | | | | | | | |
| 5 | R0 | I | RGB interface data input pins. 8 bit data bus display red data. | | | | | | | |
| 6 | R1 | I | | | | | | | | |
| 7 | R2 | I | | | | | | | | |
| 8 | R3 | I | | | | | | | | |
| 9 | R4 | I | | | | | | | | |
| 10 | R5 | I | | | | | | | | |
| 11 | R6 | I | | | | | | | | |
| 12 | R7 | I | | | | | | | | |
| 13 | G0 | I | RGB interface data input pins. 8 bit data bus display green data. | | | | | | | |
| 14 | G1 | I | | | | | | | | |
| 15 | G2 | I | | | | | | | | |
| 16 | G3 | I | | | | | | | | |
| 17 | G4 | I | | | | | | | | |
| 18 | G5 | I | | | | | | | | |
| 19 | G6 | I | | | | | | | | |
| 20 | G7 | I | | | | | | | | |
| 21 | B0 | I | RGB interface data input pins. 8 bit data bus display blue data. | | | | | | | |
| 22 | B1 | I | | | | | | | | |
| 23 | B2 | I | | | | | | | | |
| 24 | B3 | I | | | | | | | | |
| 25 | B4 | I | | | | | | | | |
| 26 | B5 | I | | | | | | | | |
| 27 | B6 | I | | | | | | | | |
| 28 | B7 | I | | | | | | | | |
| 29 | GND | P | Ground. | | | | | | | |
| 30 | DCLK | I | Pixel clock input pin. | | | | | | | |
| 31 | DISP | I | DISP sets the display mode. | | | | | | | |
| | | | <table border="1"> <thead> <tr> <th>DISP</th> <th>Function Description</th> </tr> </thead> <tbody> <tr> <td>L</td> <td>Standby mode</td> </tr> <tr> <td>H</td> <td>Normal display mode</td> </tr> </tbody> </table> | DISP | Function Description | L | Standby mode | H | Normal display mode | |
| | | | DISP | Function Description | | | | | | |
| L | Standby mode | | | | | | | | | |
| H | Normal display mode | | | | | | | | | |
| | | | | | | | | | | |
| 32 | HSYNC | I | Horizontal sync input with negative polarity. | | | | | | | |
| 33 | VSYNC | I | Vertical sync input with negative polarity. | | | | | | | |
| 34 | DEN | I | Input data enable control.Display access is enabled when DEN is "H". | | | | | | | |
| 35 | NC | - | No connection | | | | | | | |
| 36 | GND | P | Ground. | | | | | | | |
| 37 | NC | - | No connection | | | | | | | |
| 38 | NC | - | No connection | | | | | | | |
| 39 | NC | - | No connection | | | | | | | |
| 40 | NC | - | No connection | | | | | | | |

PS. For further details, please refer to ST7283 data sheet.

4. Absolute Maximum Rating

AGND = GND = 0V, Ta = 25°C

| Item | Symbol | Min | Max | Unit | Remark |
|-----------------------|------------------|------|-----|------|--------|
| Power Voltage | VDD | -0.3 | 4.0 | V | |
| Operating Temperature | T _{OPR} | -20 | 70 | °C | |
| Storage Temperature | T _{STG} | -30 | 80 | °C | |

Note1: The absolute maximum rating values of this product are not allowed to be exceeded at any times. Should a module be used with any of the absolute maximum ratings exceeded, the characteristics of the module may not be recovered, or in an extreme case, the module may be permanently destroyed.

5. Electrical Characteristics

5.1. Recommended Operating Condition

AGND = GND = 0V, Ta = 25°C

| Item | Symbol | Min | Typ. | Max | Unit | Remark |
|--------------------------|-----------------|---------|------|--------|------|--------|
| Power Voltage | VDD | 3.0 | 3.3 | 3.6 | V | |
| Input logic high voltage | V _{ih} | 0.7 VDD | - | VDD | V | |
| Input logic low voltage | V _{il} | GND | - | 0.3VDD | V | |

5.2. Recommended Driving Condition for Backlight

Ta = 25°C

| Item | Symbol | Min | Typ. | Max | Unit | Remark |
|---------------------|----------------|-------|------|------|-------|--------|
| Forward Voltage | V _f | 16.8 | 18.6 | 19.8 | V | |
| Forward Current | I _f | | 40 | | mA | |
| Operating Life Time | - | 30000 | | | Hours | |

Note 1: Ta means ambient temperature of TFT-LCD module.

Note 2: If the module is driven by high current or at high ambient temperature & humidity condition. The operating life will be reduced.

Note 3: Operating life means brightness goes down to 50% initial brightness. Minimum operating life time is estimated data.

6. Timing Characteristics

6.1. AC Electrical Characteristics

AC Electrical Characteristics (PVDD=VDD=VDDI= 3.3V, AGND= 0V, TA=25 °C, Bare Chip)

System Operation AC Characteristics

| Item | Symbol | Min. | Typ. | Max. | Unit | Conditions |
|------------------------------|--------|------|------|------|------|---|
| VDD Power Source Slew Time | TPOR | - | - | 20 | ms | From 0V to 99% VDD |
| GRB Pulse Width | tRSTW | 10 | 50 | - | us | R=10Kohm, C=1uF |
| SD Output Stable Time | Tst | - | - | 12 | us | Output settled within +20mV Loading = 6.8k+28.2pF. |
| GD Output Rise and Fall Time | Tgst | - | - | 6 | us | Output settled (5%~95%), Loading = 4.7k+29.8pF |

System Bus Timing for RGB Interface

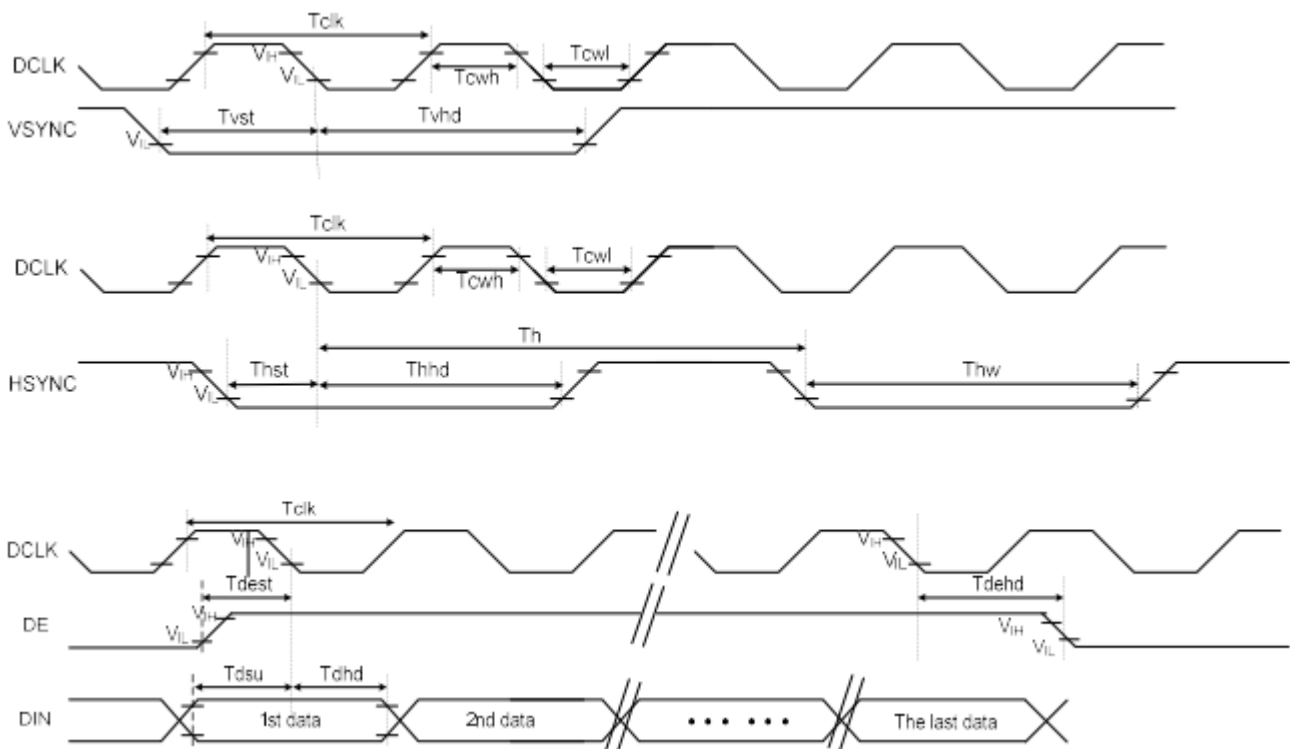

| Item | Symbol | Min. | Typ. | Max. | Unit | Conditions |
|------------------|--------|------|------|------|------|------------|
| CLK Pulse Duty | Tcw | 40 | 50 | 60 | % | |
| HSYNC Width | Thw | 2 | - | - | DCLK | |
| HSYNC Period | Th | 55 | 60 | 65 | us | |
| VSYNC Setup Time | Tvst | 12 | - | - | ns | |
| VSYNC Hold Time | Tvhd | 12 | - | - | ns | |
| HSYNC Setup Time | Thst | 12 | - | - | ns | |
| HSYNC Hold Time | Thhd | 12 | - | - | ns | |
| Data Setup Time | Tdsu | 12 | - | - | ns | |
| Data Hold Time | Tdhd | 12 | - | - | ns | |
| DE Setup Time | Tdest | 12 | - | - | ns | |
| DE Hold Time | Tdehd | 12 | - | - | ns | |

6. 2.DC Electrical Characteristics

DC Electrical Characteristics (PVDD=VDD=VDDI= 3.3V, AGND= 0V, TA=25 C, Bare Chip)

Recommended Operating Range

| Item | Symbol | Min. | Typ. | Max. | Unit | Conditions |
|----------------------------|--------|------|------|------|------|------------|
| Supply Voltage | VDD | 3.0 | 3.3 | 3.6 | V | |
| IO Supply Voltage | VDDI | 1.65 | - | 3.6 | V | |
| Charge Pump Supply Voltage | PVDD | 3.0 | 3.3 | 3.6 | V | |

DC Characteristics for Digital Circuit

| Item | Symbol | Min. | Typ. | Max. | Unit | Conditions |
|---------------------------|--------|----------|------|----------|------|------------|
| Logic-High Input Voltage | Vih | 0.7VDDI | - | VDDI | V | |
| Logic-Low Input Voltage | Vil | DGND | - | 0.3VDDI | V | |
| Logic-High Output Voltage | Voh | VDDI-0.4 | - | VDDI | V | |
| Logic-Low Output Voltage | Vol | DGND | - | DGND+0.4 | V | |

DC Characteristics for Analog Circuit

| Item | Symbol | Min. | Typ. | Max. | Unit | Conditions |
|-----------------------------|--------|------|------|------|------|---------------------|
| Positive High-Voltage Power | VGH | 13 | 15 | 16.5 | V | No Load@ FR=60Hz |
| Negative High-Voltage Power | VGL | -7 | -10 | -11 | V | |
| Output Voltage Deviation | Vod | - | ±35 | ±45 | mV | |
| Standby Current | Isc | - | - | 50 | uA | |
| Operation Current | Ioc | - | 20 | - | mA | |

6. 3.Timing

Parallel 24 bit RGB Input Timing Table

Parallel 24-bit RGB Input Timing (PVDD=VDD=VDDI= 3.3V, AGND= 0V, TA=25C)

| 480RGB X 272 Resolution Timing Table | | | | | | | |
|--------------------------------------|----------------|--------|------|------|------|--------|-----------------------|
| Item | Symbol | Min. | Typ. | Max. | Unit | Remark | |
| DCLK Frequency | Fclk | 8 | 9 | 12 | MHz | | |
| DCLK Period | Tclk | 83 | 111 | 125 | ns | | |
| HSYNC | Period Time | Th | 485 | 531 | 598 | DCLK | |
| | Display Period | Thdisp | | 480 | | DCLK | |
| | Back Porch | Thbp | 3 | 43 | 43 | DCLK | By H_BLANKING setting |
| | Front Porch | Thfp | 2 | 8 | 75 | DCLK | |
| | Pulse Width | Thw | 2 | 4 | 43 | DCLK | |
| VSYNC | Period Time | Tv | 276 | 292 | 321 | HSYNC | |
| | Display Period | Tvdisp | | 272 | | HSYNC | |
| | Back Porch | Tvbp | 2 | 12 | 12 | HSYNC | By V_BLANKING setting |
| | Front Porch | Tvfp | 2 | 8 | 37 | HSYNC | |
| | Pulse Width | Tvw | 2 | 4 | 12 | HSYNC | |

Note: It is necessary to keep Tvbp =12 and Thbp =43 in sync mode. DE mode is unnecessary to keep it.

SYNC Mode

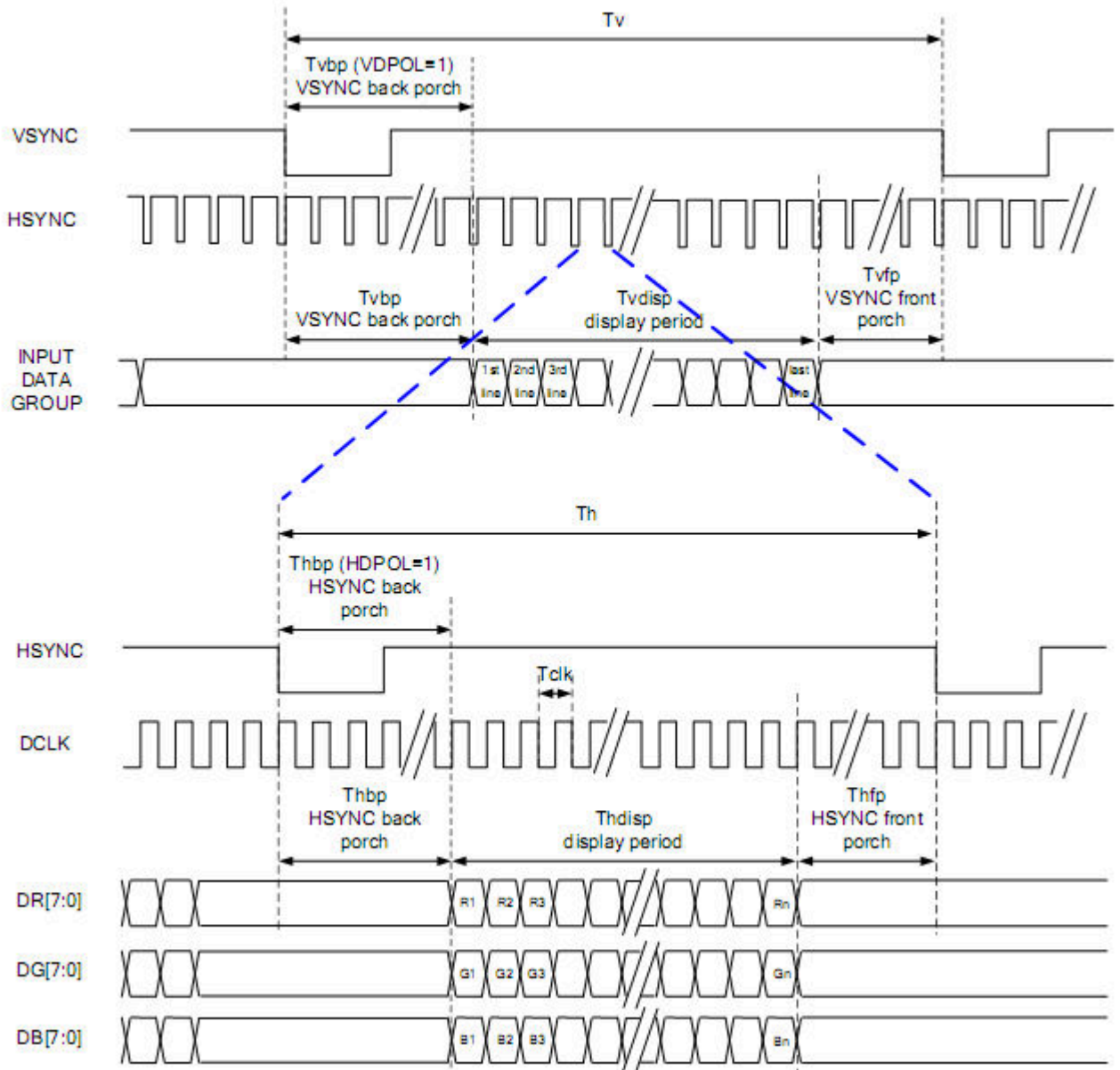

DE Mode

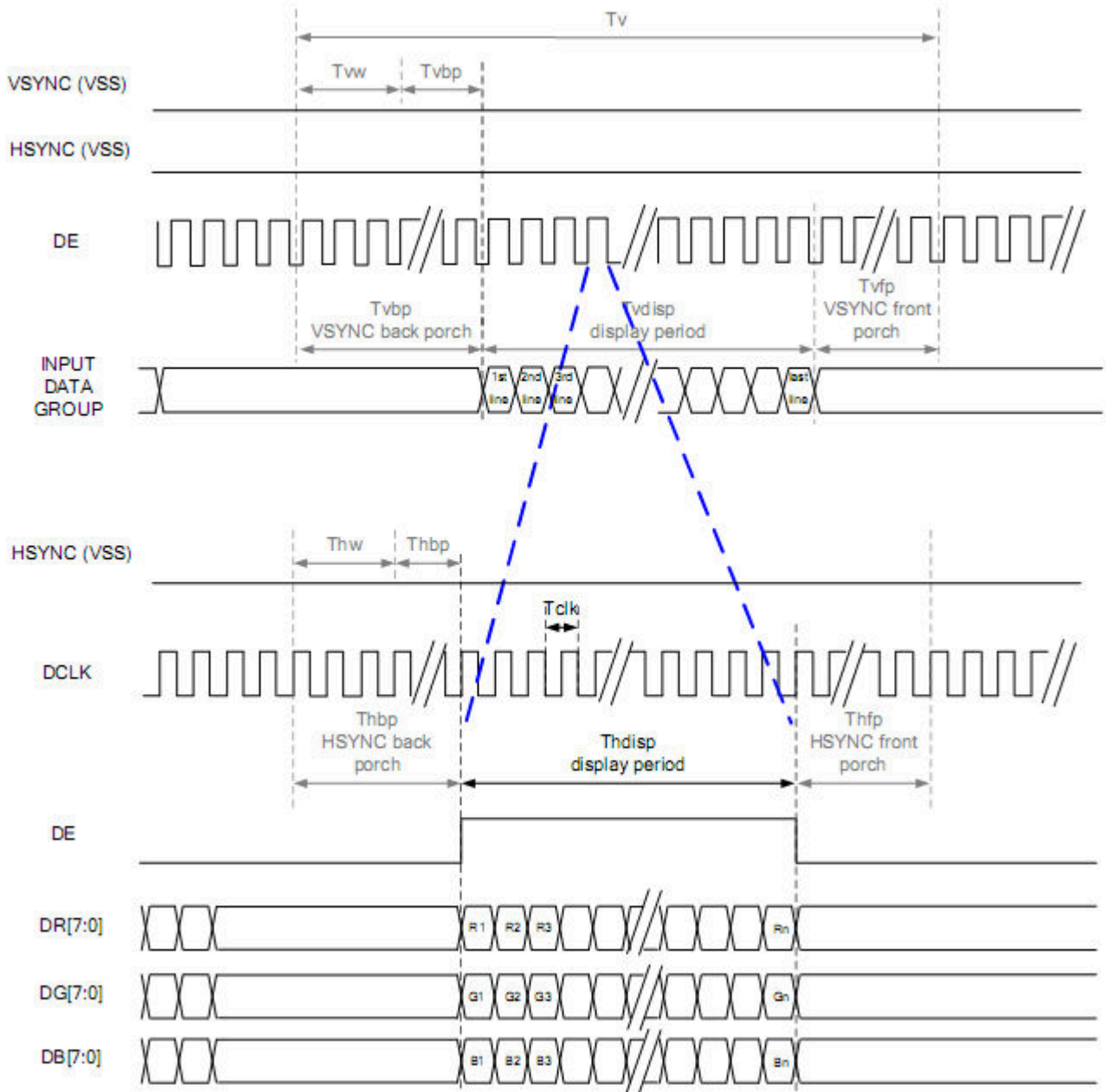

| RGB Mode Selection Table | DCLK | HSYNC | VSYNC | DE |
|--------------------------|-------|-------|-------|-------|
| SYNC - DE Mode | Input | Input | Input | Input |
| SYNC Mode | Input | Input | Input | GND |
| DE Mode | Input | GND | GND | Input |

Note: "Input" means these signals are driven by host side.

6. 4.Power ON/OFF Sequence

Power On Sequence

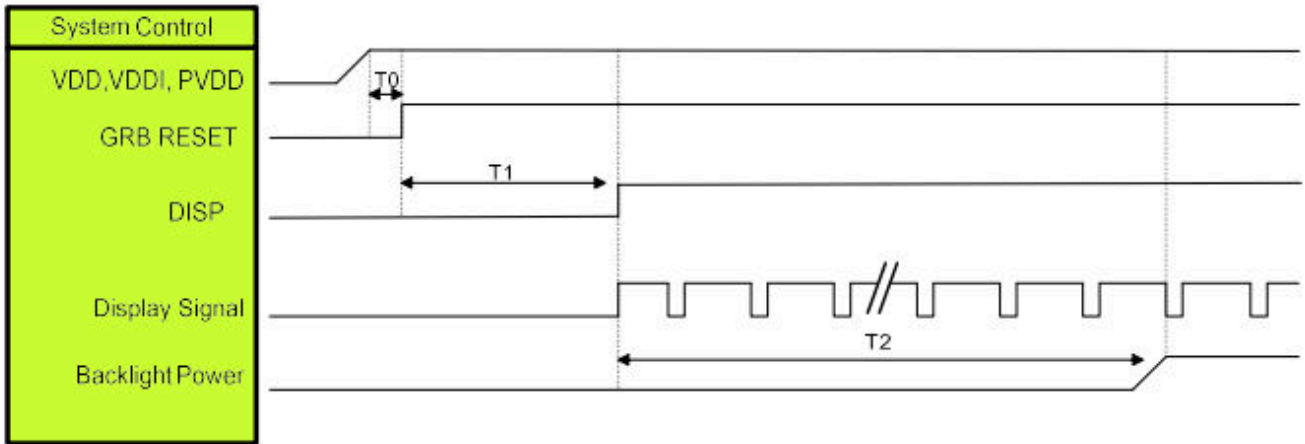

| Symbol | Description | Min. Time | Unit |
|--------|---|-----------|------|
| T0 | System power stability to GRB RESET signal | 0 | ms |
| T1 | GRB RESET= "High" to DISP="High" | 10 | ms |
| T2 | Display Signal output to Backlight Power on | 250 | ms |

Power Off Sequence

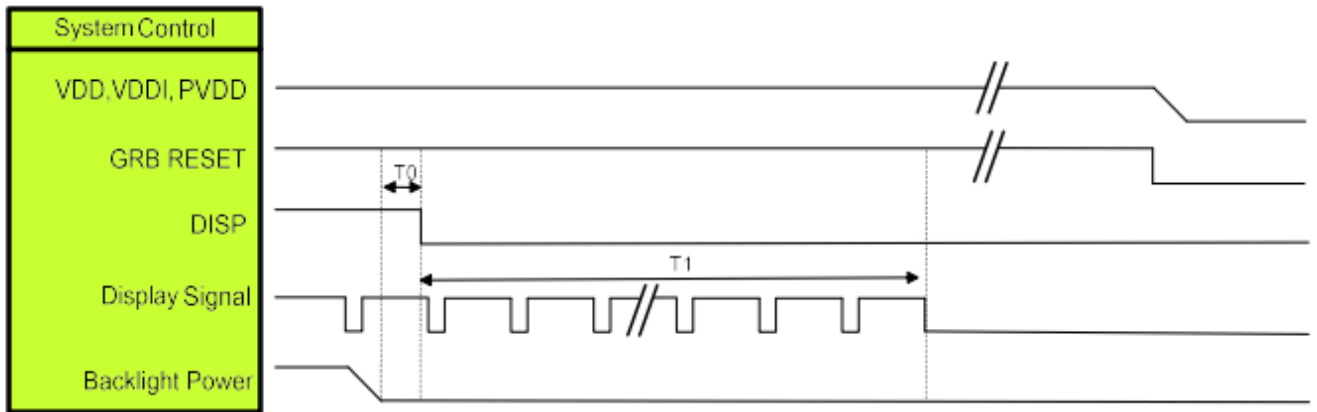

| Symbol | Description | Min. Time | Unit |
|--------|--|-----------|------|
| T0 | Backlight Power off to DISP="Low" | 5 | ms |
| T1 | DISP="Low" to IC internal voltage discharge complete | 80 | ms |

7. Optical Characteristics

| Item | Symbol | Condition | Min | Typ | Max | Unit | Remark |
|----------------|-----------------------------------|--------------------|-------|-------|-------|-------------------|------------------|
| View Angles | θT | CR \geq 10 | 80 | 85 | - | Degree | Note 2 |
| | θB | | 80 | 85 | - | | |
| | θL | | 80 | 85 | - | | |
| | θR | | 80 | 85 | - | | |
| Contrast Ratio | CR | $\theta = 0^\circ$ | 800 | 1000 | - | | Note 1 Note 3 |
| Response Time | T _{ON} +T _{OFF} | 25°C | - | 30 | 35 | ms | Note 1 Note 4 |
| Chromaticity | W _x | x | 0.272 | 0.312 | 0.352 | | Note 1 Note 5 |
| | W _y | y | 0.301 | 0.341 | 0.381 | | |
| | R _x | x | 0.547 | 0.587 | 0.627 | | |
| | R _y | y | 0.288 | 0.328 | 0.368 | | |
| | G _x | x | 0.325 | 0.365 | 0.405 | | |
| | G _y | y | 0.543 | 0.583 | 0.623 | | |
| | B _x | x | 0.111 | 0.151 | 0.191 | | |
| B _y | y | 0.081 | 0.121 | 0.161 | | | |
| Uniformity | U | | 75 | - | - | % | Note 5 |
| Luminance | L | | 400 | 550 | - | cd/m ² | Note 1 Note 5 |

Test Conditions:

1. If=40mA(Backlight current), VDD = 3.3 V, the ambient temperature is 25°C.
2. The test systems refer to Note 2.

Note1: Definition of optical measurement system.

The optical characteristics should be measured in dark room. After 5Minutes operation, the optical properties are measured at the center point of the LCD screen. ALL input terminals LCD panel must be ground when measuring the center area of the panel.

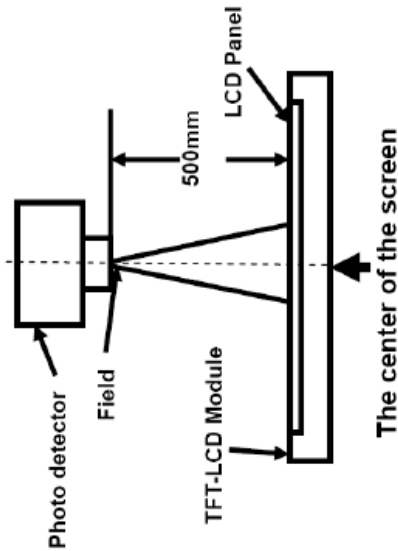

| Item | Photo detector | Field |
|----------------|----------------|-------|
| Contrast Ratio | CS1000 | 1° |
| Luminance | | |
| Lum Uniformity | | |
| Chromaticity | CS1000 | |
| Response Time | DMS703 | - |

Note2: Definition of viewing angle range and measurement system.

Viewing angle is measured at the center point of the LCD by CONOSCOPE (DMS703)

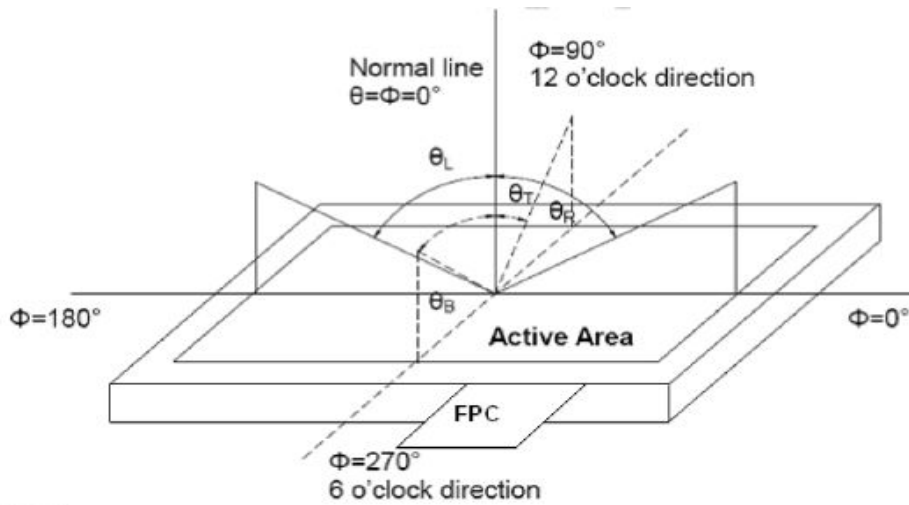

Note3: Definition of contrast ratio

White state :The state is that the LCD should drive by Vwhite.

$$\text{Contrast ratio(CR)} = \frac{\text{Luminance measured when LCD is on the "White" state}}{\text{Luminance measured when LCD is on the "Black" state}}$$

"Black state ":The state is that the LCD should drive by Vblack.

Vwhite: To be determined Vblack: To be determined

Note4: Definition of Response time

The response time is defined as the LCD optical switching time interval between "White"state and "Black" state. Rise time (T_{ON})is the time between photo detector output intensity changed from 90% to 10%.And fall time (T_{OFF})is the time between photo detector output intensity changed from 10% to90%.

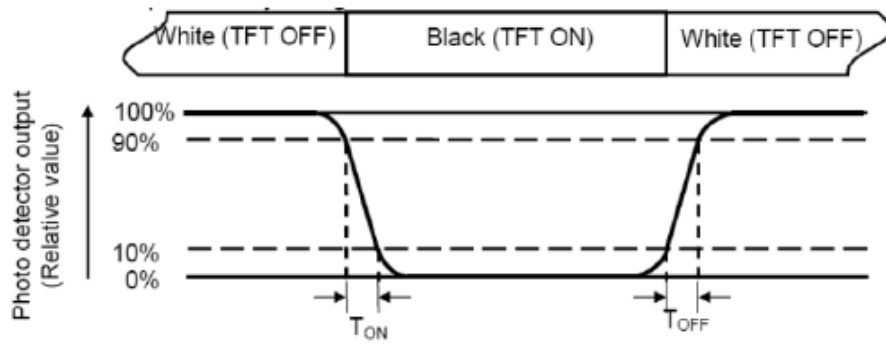

Note5: Definition of color chromaticity (CIE1931)

Color coordinates measured at center point of LCD.

Color coordinates are subject to actual measurement.

If the data has a bracket, that means reference value of TFT panel or one sample of module, the values of module TBD.

Note6: Definition of Luminance Uniformity

Active area is divided into 9 measuring areas(Refer Fig.2).Every measuring point is placed at the center of each measuring area.

Luminance Uniformity (U)=Lmin/Lmax

L-Active area length W-Active area width

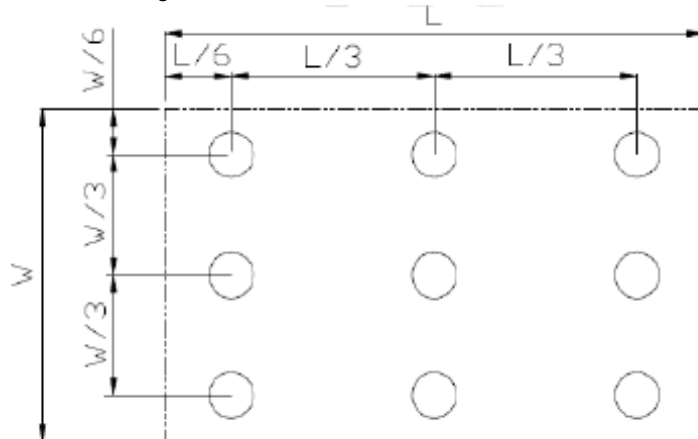

L max: The measured Maximum luminance of all measurement position.

L min: The measured Minimum luminance of all measurement position.

Note7: Definition of luminance: Measure the luminance of white state at center point.

8. Environmental/Reliability Test

| No. | Test Item | Test Condition | Inspection after test |
|-----|----------------------------|--|--|
| 1 | High Temperature Storage | 80±2°C/240 hours | Inspection after 2~4hours storage at room temperature, the sample shall be free from defects: 1.Air bubble in the LCD; 2.Sealleak; 3.Non-display; 4.Missing segments; 5.Glass crack; 6.Current Idd is twice higher than initial value. |
| 2 | Low Temperature Storage | -30±2°C/240 hours | |
| 3 | High Temperature Operating | 70±2°C/240 hours | |
| 4 | Low Temperature Operating | -20±2°C/240 hours | |
| 5 | Temperature Cycle | -30°C~ 25°C~ 80°C × 10cycles (30min.) (5min.) (30min.) | |
| 6 | Damp Proof Test | 40°C±5°C×90%RH/240 hours | |
| 7 | Vibration Test | Frequency : 10Hz~55Hz~10Hz Amplitude : 1.5mm, X, Y, Z direction for total 3hours (Packing condition) | |
| 8 | Dropping test | Drop to the ground from 1m height, one time, every side of carton. (Packing condition) | |
| 9 | ESD test | Voltage:±8KV R: 330Ω C: 150pF Air discharge, 10time Voltage:±6KV R: 330Ω C: 150pF Contact discharge, 10time | |

Remark:

1. The test samples should be applied to only one test item.
2. Sample size for each test item is 5~10pcs.
3. For Damp Proof Test, Pure water(Resistance> 10MΩ) should be used.
4. In case of malfunction defect caused by ESD damage, if it would be recovered to normal state after resetting, it would be judge as a good part.
5. Failure Judgment Criterion: Basic Specification, Electrical Characteristic, Mechanical Characteristic, Optical Characteristic.
6. Please use automatic switch menu(or roll menu) testing mode when test operating mode.

9. Packing Drawing

PACKING TYPE: BY EPE TRAY(T430ILAU-02-100A)

PACKLING ORDER:

1) Putting 6 pcs Modules on each EPE tray.

2) Putting 7 pcs EPE trays together with EPE paper on the top of EPE tray.

3) Assembling the boards and the tray together with adhesive tape

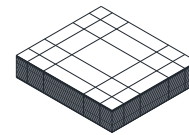
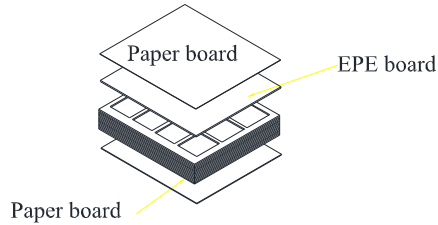

4) Putting in the inner small carton (TYPE:H82)

5) Putting 5 small cartons into one outcarton

6) Packing finished

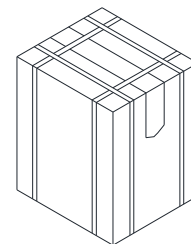
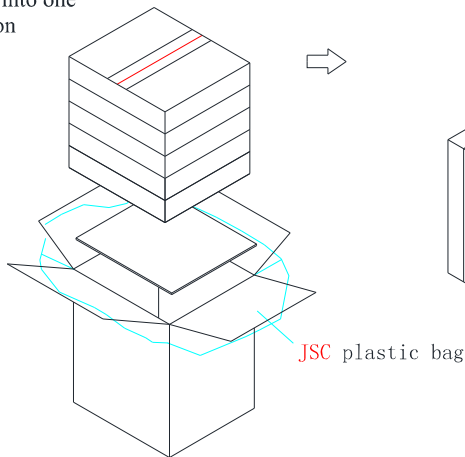
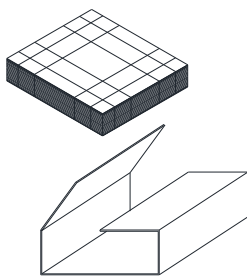

Note: 6 pcs in a tray, 7 trays in a inner carton, 5 inner cartons in a out carton, so 6x7x5=210pcs/Outcarton
 Dimension (Small carton): 385*325*87mm Dimension (Out carton): 394*344*470mm

10. Standard Specifications For Product Quality

10.1. Manner of test:

10.1.1 The test must be under 40W fluorescent light, and the distance of view must be at 35±5cm

10.1.2 Room temperature 25±5°C Humidity: (65±5)%RH.

10.1.3 If the product is uneven and bright spot, use 2%ND filter to check and confirm. Not visible, OK.

10.1.4 Inspection Angle:

The vision of inspector should be perpendicular to the surface of the Module.

10.1.5 Inspection time :

Perceptibility Test Time: 20 seconds max.

10.2. Quality specification

It shall be based on GB2828, inspection level II.

| | IETM | CHECK LEVEL | AQL |
|------------|---|-------------|------|
| MAJOR (MA) | 1. Liquid crystal leakage 2. Wrong polarizer 3. Outside dimension 4. Bright dot, Dark dot 5. Display abnormal 6. Glass crack | II | 0.25 |
| MINOR (MI) | 1. Spot Defect (Including black spot, white spot, pinhole, foreign particle, bubbles, hurt) 2. Fragment 3. Line Defect (Including black line, white line, scratch) 4. Incision defect 5. Newton's ring 6. Other visual defects | II | 1.0 |

10.3 Definition of area

10.3.1 I area: viewing area

II area: outside viewing area

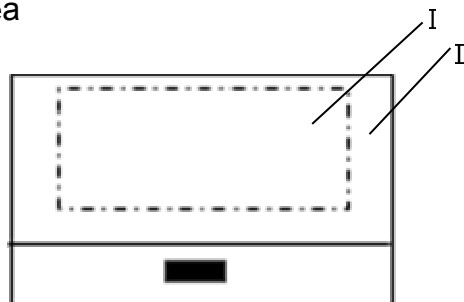

10.4. Standard of appearance test for I area: (unit: mm)

NOTE : Defect ignore for II area.

10.4.1 Bright/Dark Dots explain

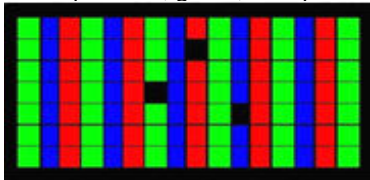
| Name | Explain | Definition |
|--------------|---|--|
| Bright dot | <p>Dots appear bright and unchanged in size in which LCD panel is displaying under black pattern.</p>  | <p>The definition of dot: The size of a defective dot over 1/2 of single pixel dot is regarded as one defective dot .</p> <p>Note:One pixel consists of 3 sub-pixels, including R,G, and B dot.(Sub-pixel = Dot)</p> |
| Dark dot | <p>Dots appear dark and unchanged in size in which LCD panel is displaying under pure red, green, blue pattern.</p>  | |
| Adjacent Dot | <p>Adjacent two sub-pixel are defect (define two dot defect)</p> | |

10.4.2 Inspection standard

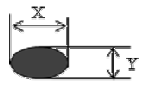
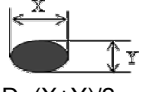
| No | Items | Criterion | | | | Checking manner | Defect classes | |
|----|--|---|---------------------|---------------------|---------------------|--------------------|--------------------|--|
| 1 | Bright/dark dot (亮、暗点) | LCD≤4.3" | 4.3" < LCD < 7" | 7"≤LCD≤12" | LCD > 12" | Checking with eyes | MAJ | |
| | | Bright dot : N≤2 | Bright dot : N≤3 | Bright dot : N≤4 | Bright dot : N≤5 | | Checking with eyes | |
| | | Dark dot : N≤3 | Dark dot : N≤4 | Dark dot : N≤5 | Dark dot : N≤6 | | | |
| | | Total : N≤4 | Total : N≤6 | Total : N≤8 | Total : N≤10 | | | |
| | | The distance between the two defect dots shall be greater than 5mm The distance between two defect dots above 7 inches shall be more than 10 mm Note: Adjacent dot defect N≤0 | | | | | | |
| 2 | Spot defects (black and white spot, pinhole, foreign matter, dent, backlight foreign matter)  D=(X+Y)/2 | D≤0.15 Ignore | D≤0.2 Ignore | D≤0.2 Ignore | D≤0.2 Ignore | Checking with eyes | MIN | |
| | | 0.15 < D≤0.3 N≤3 | 0.2 < D≤0.5 N≤4 | 0.2 < D≤0.5 N≤5 | 0.2 < D≤0.5 N≤6 | | | |
| 3 | Bubble  D=(X+Y)/2 | 0.3 < D N=0 | 0.5 < D N=0 | 0.5 < D N=0 | 0.5 < D N=0 | Checking with eyes | | |
| | | 0.2 < D≤0.5 N≤3 | 0.2 < D≤0.5 N≤4 | 0.2 < D≤0.5 N≤5 | 0.2 < D≤0.5 N≤6 | | | |
| | | 0.5 < D N=0 | 0.5 < D N=0 | 0.5 < D N=0 | 0.5 < D N=0 | | | |

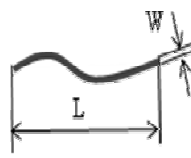
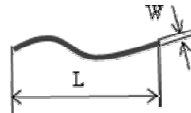
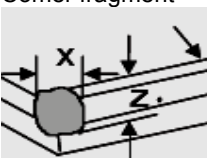
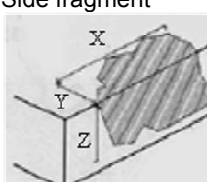
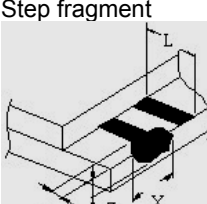
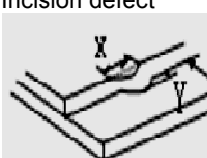
| No | Items | Criterion | | | | Checking manner | Defect classes |
|----|--|--|--|--|--|--------------------|----------------|
| 4 | Line defects(black and white line, backlight foreign matter etc.)  | LCD≤4.3" | 4.3" < LCD < 7" | 7"≤LCD≤12" | LCD > 12" | Checking with eyes | MIN |
| | | W≤0.03 Ignore 0.03 < W≤0.06 L≤5 N≤3 W > 0.06 L > 5 N=0 | W≤0.03 Ignore 0.03 < W≤0.1 L≤5 N≤4 W > 0.1 L > 5 N=0 | W≤0.03 Ignore 0.03 < W≤0.1 L≤5 N≤5 W > 0.1 L > 5 N=0 | W≤0.03 Ignore 0.03 < W≤0.1 L≤5 N≤6 W > 0.1 L > 5 N=0 | | |
| 5 | Scratch  | W≤0.03 Ignore 0.03 < W≤0.2 1.0 < L≤ 5.0 N≤3 W > 0.2 L > 5 N=0 | W≤0.03 Ignore 0.03 < W≤0.2 1.0 < L≤ 5.0 N≤4 W > 0.2 L > 5 N=0 | W≤0.03 Ignore 0.03 < W≤0.2 1.0 < L≤ 5.0 N≤5 W > 0.2 L > 5 N=0 | W≤0.03 Ignore 0.03 < W≤0.2 1.0 < L≤ 5.0 N≤6 W > 0.2 L > 5 N=0 | Checking with eyes | MIN |
| 6 | Display abnormal | Not allowed | | | | Checking with eyes | MAJ |
| 7 | Outside dimension | Accord with drawing | | | | Calipers | MAJ |
| 8 | Glass crack | Not allowed | | | | Checking with eyes | MAJ |
| 9 | Leak | Not allowed | | | | Checking with eyes | MAJ |
| 10 | Comer fragment  | X≤3 Y≤3 Z≤T Ignore Note : 1、 no hurt identifying 、 wire、 seal 2、 T: Glass thickness X: Length Y: Width Z: thickness | | | | Checking with eyes | MIN |
| | Side fragment  | Y≤1 Z≤T Ignore Note : 1、 no hurt identifying 、 wire、 seal 2、 T : Glass thickness X: Length Y: Width Z: thickness | | | | Checking with eyes | MIN |
| 11 | Step fragment  | Y≤1 and Y≤1/4 L | | | | Checking with eyes | MIN |
| | Incision defect  | Y≤1 and accord with outside dimension | | | | Checking with eyes | MIN |

11. Precautions for Use of LCD Modules

11.1 Handling Precautions

- (1) The display panel is made of glass and polarizer. As glass is fragile. It tends to become or chipped during handling especially on the edges. Please avoid dropping or jarring. Do not subject it to a mechanical shock by dropping it or impact.
- (2) If the display panel is damaged and the liquid crystal substance leaks out, be sure not to get any in your mouth. If the substance contacts your skin or clothes, wash it off using soap and water.
- (3) Do not apply excessive force to the display surface or the adjoining areas since this may cause the color tone to vary. Do not touch the display with bare hands. This will stain the display area and degraded insulation between terminals (some cosmetics are determined to the polarizer).
- (4) The polarizer covering the display surface of the LCD module is soft and easily scratched. Handle this polarizer carefully. Do not touch, push or rub the exposed polarizer with anything harder than an HB pencil lead (glass, tweezers, etc.). Do not put or attach anything on the display area to avoid leaving marks on. Condensation on the surface and contact with terminals due to cold will damage, stain or dirty the polarizer. After products are tested at low temperature they must be warmed up in a container before coming in contact with room temperature air.
- (5) If the display surface becomes contaminated, breathe on the surface and gently wipe it with a soft dry cloth. If it is heavily contaminated, moisten cloth with one of the following solvents
 - Isopropyl alcohol
 - Ethyl alcohol
 - Do not scrub hard to avoid damaging the display surface.
- (6) Solvents other than those above-mentioned may damage the polarizer. Especially, do not use the following.
 - Water
 - Ketone
 - Aromatic solvents

Wipe off saliva or water drops immediately, contact with water over a long period of time may cause deformation or color fading. Avoid contacting oil and fats.
- (7) Exercise care to minimize corrosion of the electrode. Corrosion of the electrodes is accelerated by water droplets, moisture condensation or a current flow in a high-humidity environment.
- (8) Install the LCD Module by using the mounting holes. When mounting the LCD module make sure it is free of twisting, warping and distortion. In particular, do not forcibly pull or bend the I/O cable or the backlight cable.
- (9) Do not attempt to disassemble or process the LCD module.
- (10) NC terminal should be open. Do not connect anything.
- (11) If the logic circuit power is off, do not apply the input signals.
- (12) Electro-Static Discharge Control, Since this module uses a CMOS LSI, the same careful attention should be paid to electrostatic discharge as for an ordinary CMOS IC. To prevent destruction of the elements by static electricity, be careful to maintain an optimum work environment.
 - Before remove LCM from its packing case or incorporating it into a set, be sure the module and your body have the same electric potential. Be sure to ground the body when handling the LCD modules.
 - Tools required for assembling, such as soldering irons, must be properly grounded. make certain the AC power source for the soldering iron does not leak. When using an electric screwdriver to attach LCM, the screwdriver should be of ground potentiality to minimize as much as possible any transmission of electromagnetic waves produced sparks coming from the commutator of the motor.
 - To reduce the amount of static electricity generated, do not conduct assembling and other work under dry conditions. To reduce the generation of static electricity be careful that the air in the work is not too dried. A relative humidity of 50%-60% is recommended. As far as possible make the electric potential of your work clothes and that of the work bench the ground potential.

The LCD module is coated with a film to protect the display surface. Exercise care when peeling off this protective film since static electricity may be generated.

- (13) Since LCM has been assembled and adjusted with a high degree of precision, avoid applying excessive shocks to the module or making any alterations or modifications to it.
- Do not alter, modify or change the shape of the tab on the metal frame.
 - Do not make extra holes on the printed circuit board, modify its shape or change the positions of components to be attached.
 - Do not damage or modify the pattern writing on the printed circuit board.
 - Absolutely do not modify the zebra rubber strip (conductive rubber) or heat seal connector.
 - Except for soldering the interface, do not make any alterations or modifications with a soldering iron.
 - Do not drop, bend or twist LCM.

11.2 Storage Precautions

When storing the LCD modules, the following precaution is necessary.

- (1) Store them in a sealed polyethylene bag. If properly sealed, there is no need for the dessicant.
- (2) Store them in a dark place. Do not expose to sunlight or fluorescent light, keep the temperature between 0°C and 35°C.
- (3) The polarizer surface should not come in contact with any other objects. (We advise you to store them in the container in which they were shipped).

11.3 Others

- (1) Liquid crystals solidify under low temperature (below the storage temperature range) leading to defective orientation or the generation of air bubbles (black or white). Air bubbles may also be generated if the module is subject to a low temperature.
- (2) If the LCD modules have been operating for a long time showing the same display patterns, the display patterns may remain on the screen as ghost images and a slight contrast irregularity may also appear. A normal operating status can be regained by suspending use for some time. It should be noted that this phenomenon does not adversely affect performance reliability.
- (3) To minimize the performance degradation of the LCD modules resulting from destruction caused by static electricity etc., exercise care to avoid holding the following sections when handling the modules.
 - Exposed area of the printed circuit board.
 - Terminal electrode sections.

11.4 USING LCD MODULES

Installing LCD Modules

The hole in the printed circuit board is used to fix LCM as shown in the picture below. Attend to the following items when installing the LCM.

- (1) Cover the surface with a transparent protective plate to protect the polarizer and LC cell.

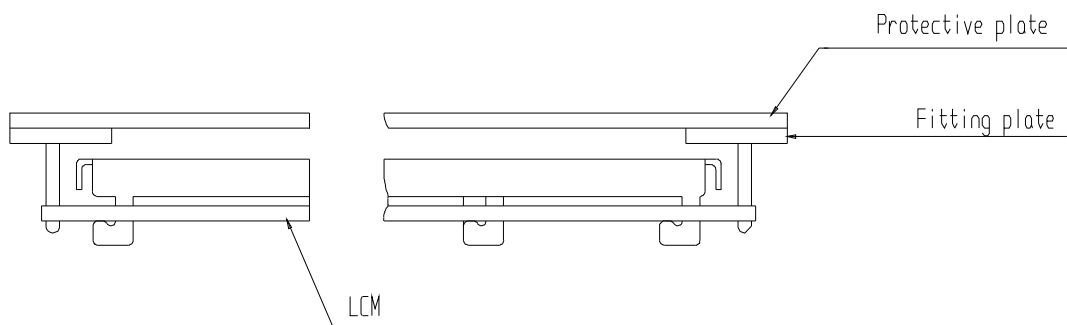

- (2) When assembling the LCM into other equipment, the spacer to the bit between the LCM and the fitting plate should have enough height to avoid causing stress to the module surface, refer to the individual specifications for measurements. The measurement tolerance should be 0.1mm.

Precaution for assemble the module with BTB connector:

Please note the position of the male and female connector position, don't assemble or assemble like the method which the following picture shows

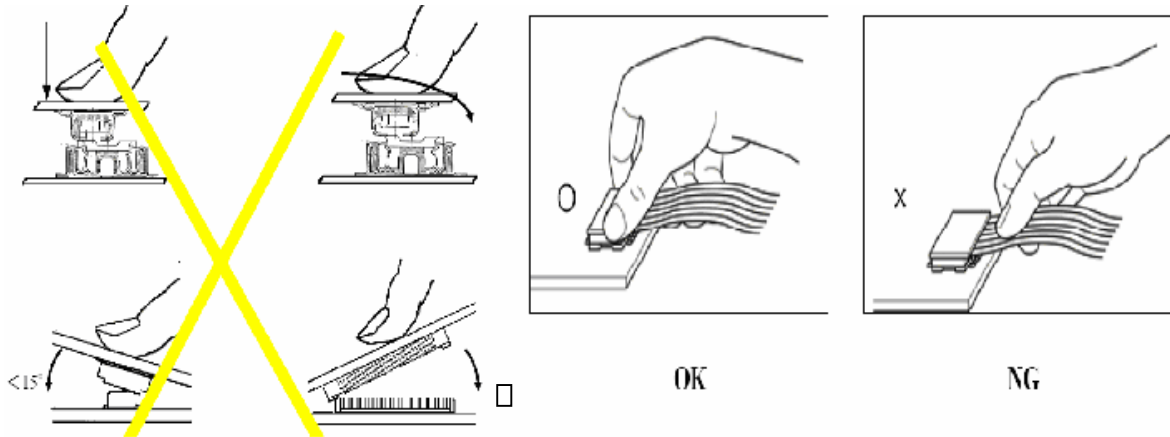

Precaution for soldering to the LCM

| | Hand soldering | Machine drag soldering | Machine press soldering |
|-----------------|-----------------------------|--------------------------------|--|
| No ROHS Product | 290 C~350 C. Time :3-5S. | 330 C ~350 C. Speed : 4-8mm/s. | 300 C~330C. Time : 3-6S. Press: 0.8~1.2Mpa |
| ROHS Product | 340 C~370 C. Time:3-5S. | 350 C ~370 C. Time : 4-8 mm/s. | 330 C~360C. Time : 3-6S. Press: 0.8~1.2Mpa |

- (1) If soldering flux is used, be sure to remove any remaining flux after finishing to soldering operation. (This does not apply in the case of a non-halogen type of flux.) It is recommended that you protect the LCD surface with a cover during soldering to prevent any damage due to flux spatters.
- (2) When soldering the electroluminescent panel and PC board, the panel and board should not be detached more than three times. This maximum number is determined by the temperature and time conditions mentioned above, though there may be some variance depending on the temperature of the soldering iron.
- (3) When remove the electroluminescent panel from the PC board, be sure the solder has completely melted, the soldered pad on the PC board could be damaged.

Precautions for Operation

- (1) It is an indispensable condition to drive LCD's within the specified voltage limit since the higher voltage then the limit cause the shorter LCD life. An electrochemical reaction due to direct current causes LCD's undesirable deterioration, so that the use of direct current drive should be avoided.
- (2) Response time will be extremely delayed at lower temperature than the operating temperature range and on the other hand at higher temperature LCD's show dark color in them. However those phenomena do not mean malfunction or out of order with LCD's, which will come back in the specified operating temperature.
- (3) If the display area is pushed hard during operation, the display will become abnormal. However, it will return to normal if it is turned off and then back on.
- (4) A slight dew depositing on terminals is a cause for electro-chemical reaction resulting in terminal open circuit. Usage under the maximum operating temperature,50%RH or less is required.
- (5) Input each signal after the positive/negative voltage becomes stable.
- (6) Please keep the temperature within specified range for use and storage. Polarization degradation, bubble generation or polarizer peel-off may occur with high temperature and high humidity.

Safety

- (1) It is recommended to crush damaged or unnecessary LCDs into pieces and wash them off with solvents such as acetone and ethanol, which should later be burned.
- (2) If any liquid leaks out of a damaged glass cell and comes in contact with the hands, wash off thoroughly with soap and water.

11.5 The disposal of waste

For waste disposal, our recommendations are as follows, please refer to your company, and the relevant provisions of the state laws and regulations of the act accordingly

1. Packing materials disposal for our packaging (carton/PS tray/EPE tray/PET tray)
 - 1) Our company used to recycle and reuse materials, packing materials can be you just need to transfer to material recycling companies
 2. Our scrap module can't be recycled for reuse, so please dispose of:
 - 1) Our scrap module can't be recycled for reuse, products and components are "served" can lead to accidents
 - 2) Our scrap can be transfer to material recycling companies, dismantling, to ensure that scrap in relatively advanced technology products, environmental protection measures of relatively perfect environment for processing.
3. WEEE order must be executed in product scrap.