

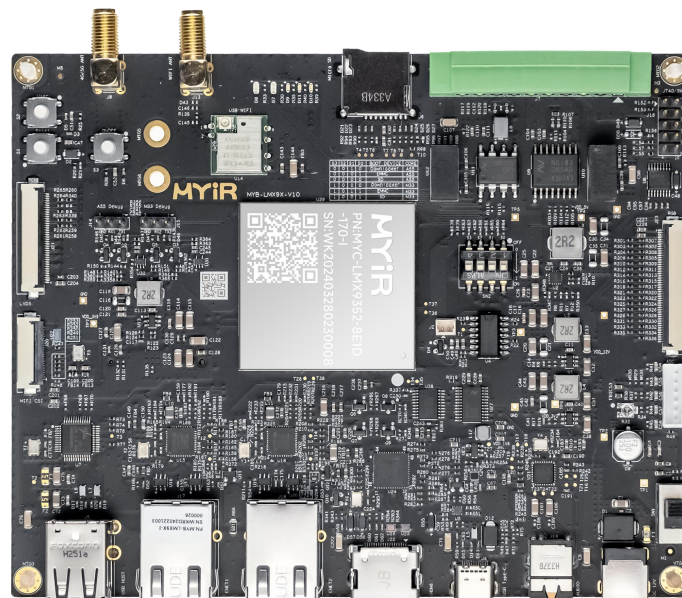

MYD-LMX9X Development Board Overview



- ✓ MYC-LMX9X SOM as Controller Board
- ✓ NXP i.MX 9352 Application Processor based on 1.7 GHz Dual Arm Cortex-A55 and 250MHz Cortex-M33 Cores
- ✓ 1GB/2GB LPDDR4, 8GB eMMC Flash, 32KB EEPROM
- ✓ UARTs, 2 x USB 2.0 Host, 1 x USB 2.0 OTG, 1 x Micro SD Card Slot, CAN/RS485/RS232
- ✓ 2 x Gigabit Ethernet, 1 x 4G/5G Module Interface, 1 x WiFi Module
- ✓ Supports HDMI and LVDS Display, Camera Interface (MIPI-CSI), Audio Input and Output
- ✓ Ready to Run Linux 6.1 OS



The [MYD-LMX9X Development Board](#) is an advanced evaluation platform specifically designed for the NXP i.MX 9352 processor. This processor boasts up to 1.7GHz Dual ARM Cortex-A55 and 250MHz Cortex-M33 cores, belonging to the esteemed [NXP i.MX 93](#) family. It offers rapid and efficient ML inference alongside a comprehensive set of peripherals and high-performance application cores tailored for the automotive, industrial, and consumer IoT market segments. The board is ready to run Linux OS and supports an industrial operating temperature range of -40 to +85 Celsius.

The [MYD-LMX9X Development Board](#) is built around the [MYC-LMX9X System-On-Module](#) (SOM) and has explored many features of the NXP i.MX 9352 SoC through the 218-pin LGA expansion interface. It provides a range of advanced connectivity options, including RS232, RS485, two USB2.0, one USB OTG, two Gigabit Ethernet, one CAN, one Micro SD card slot, one M.2 Socket for USB based 4G/5G LTE Module with dual SIM card holders. Furthermore, it incorporates a USB2.0 based WiFi module, an Audio interface, a Mini-CSI interface, and multiple display interfaces: HDMI, LVDS, and RGB.

The MYD-LMX9X Development Board is delivered with a Quick Start Guide, one USB to TTL serial cable and one 12V/2A power adapter. MYIR also offers [MY-CAM003M MIPI Camera Module](#), [MY-LVDS070C 7-inch LVDS Module](#) and [MY-LCD70TP-C 7-inch LCD Module](#) as add-on options for the board.

The MYD-LMX9X Development Board is capable of running Linux 6.1 Operating System, ensuring stable and efficient performance. MYIR offers abundant software resources, including kernel and driver source code, as well as detailed documentations and tools that facilitate rapid and easy development for users. These resources provide developers with the necessary support to focus on creating innovative and exciting applications.

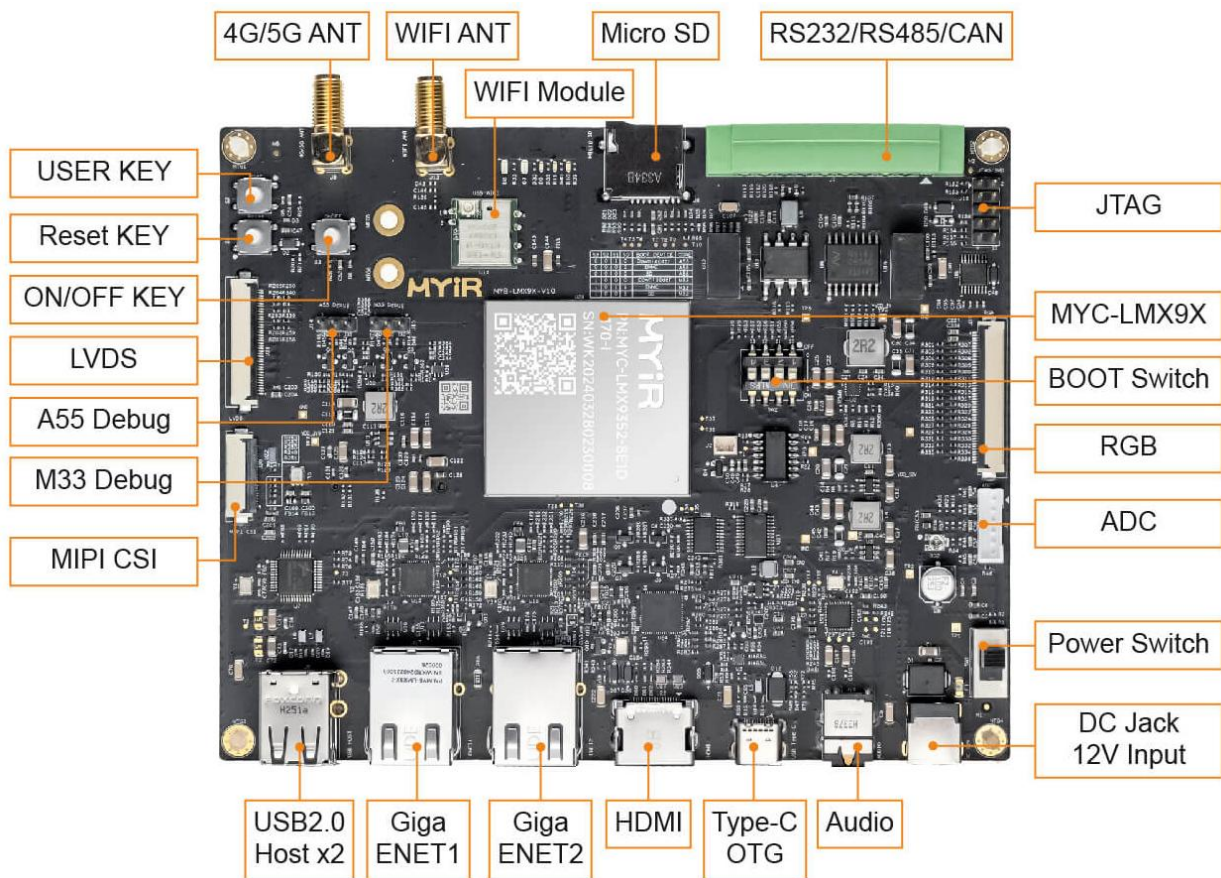

MYD-LMX9X Development Board (Top view)

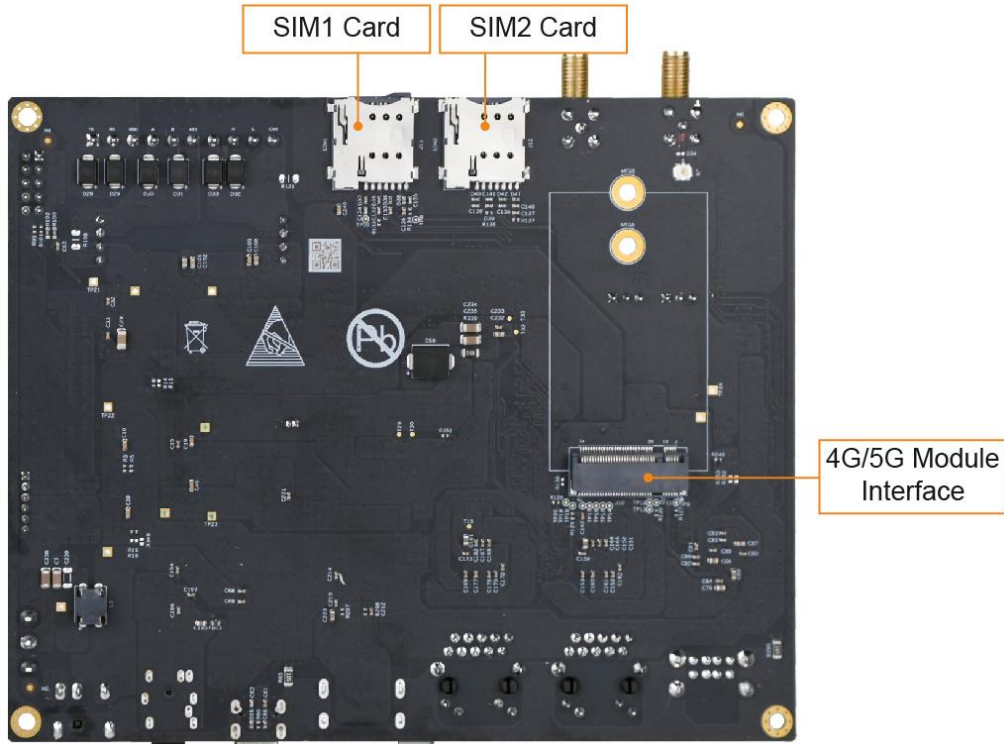

MYD-LMX9X Development Board (Bottom view)

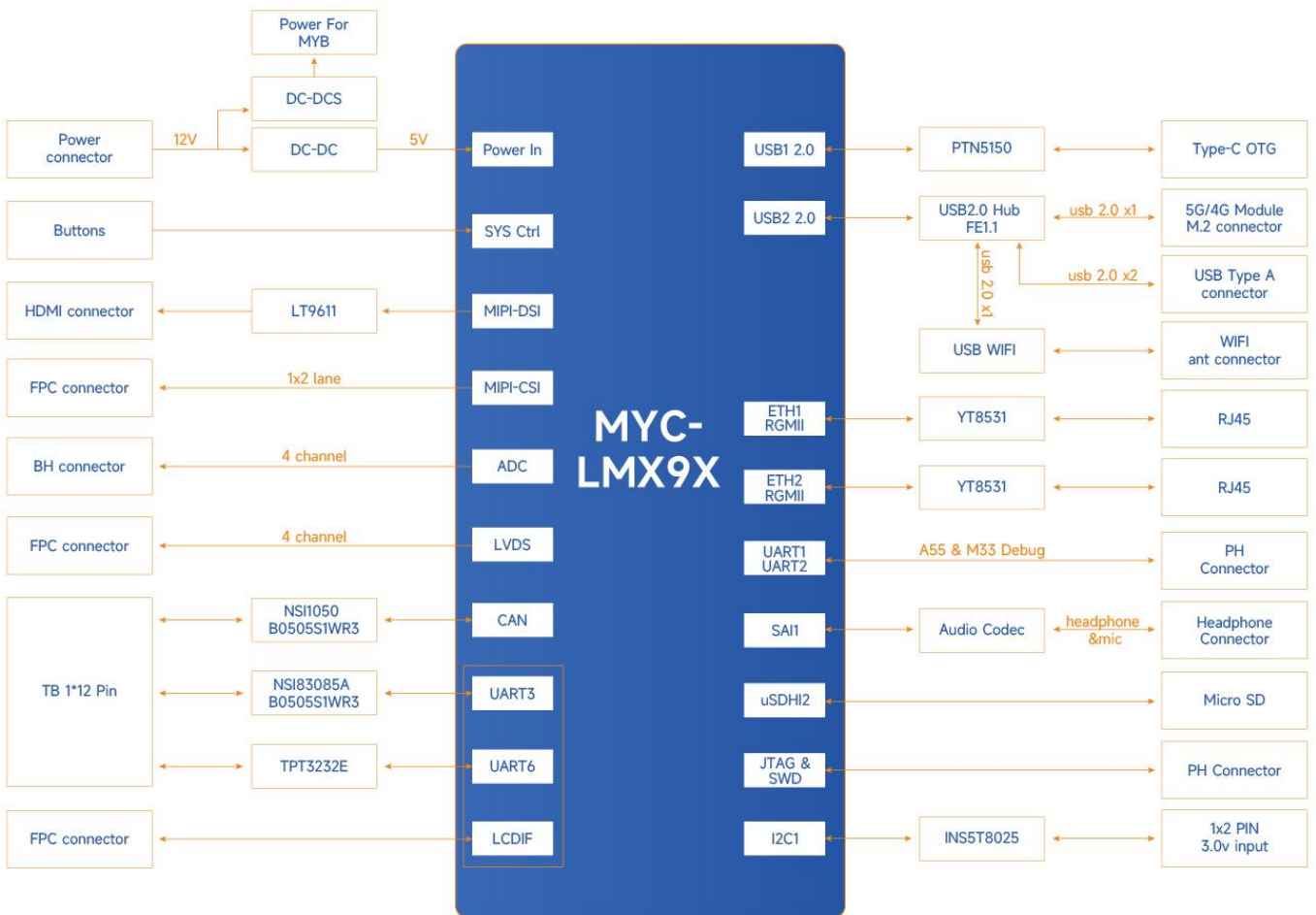

MYD-LMX9X Function Block Diagram



Hardware Specification

The [i.MX 93 family](#) represents NXP's latest power-optimized processors for smart home, building control, contactless HMI, IoT edge, Automotive, and Industrial applications. The i.MX 93 includes powerful dual Arm® Cortex®-A55 processors with speeds up to 1.7 GHz integrated with a NPU that accelerates machine learning inference. A general-purpose Arm® Cortex®-M33 running up to 250 MHz is for real-time and low-power processing. Robust control networks are possible via CAN-FD interface. Also, dual 1 Gbps Ethernet controllers, one supporting Time Sensitive Networking (TSN), drive gateway applications with low latency.



i.MX93 Processor Block Diagram

The MYC-LMX9X is driven by the 11 x 11mm package (198 IO pins) i.MX 9352 processor, comprising dual Cortex-A55 cores running at 1.7 GHz alongside a Cortex-M33 core operating at 250MHz.

PN	NPU	Arm CPU	Package	Camera Interface	Display Interface	Networking & Connectivity	Audio
MIMX9352xxxxxxx	Y	2x	11x11mm (198 IO pins)	2-lane 1080p30 MIPI CSI, Parallel camera	4-lane 1080p60 MIPI DSI, 4-lane LVDS, Parallel display	2x GbE, 2x USB 2.0	7x I2S TDM
MIMX9351xxxxxxx	Y	1x					
MIMX9332xxxxxxx	N	2x					
MIMX9331xxxxxxx	N	1x	9x9mm (138 IO pins)	Parallel camera	Parallel display	1x GbE, 1x USB 2.0	3x I2S TDM
MIMX9321xxxxxxx	Y	1x					
MIMX9311xxxxxxx	N	1x					

i.MX 93 Product Features



The MYD-LMX9X Development Board uses the MYC-LMX9X SOM as its core controller board, leveraging the advantages of the NXP i.MX 9352 processor. The main features are characterized as below:

Mechanical Parameters

- Dimensions: 120mm x 150mm (base board), 37mm x 39mm (SOM)
- PCB Layers: 6-layer design (base board), 10-layer design (SOM)
- Power supply: +12V/2A (base board), +5V/1A (SOM)
- Working temperature: -40~85 Celsius (industrial grade)
(WiFi Module: -20~70 Celsius)

The MYD-LMX9X Controller Board (MYC-LMX9X)

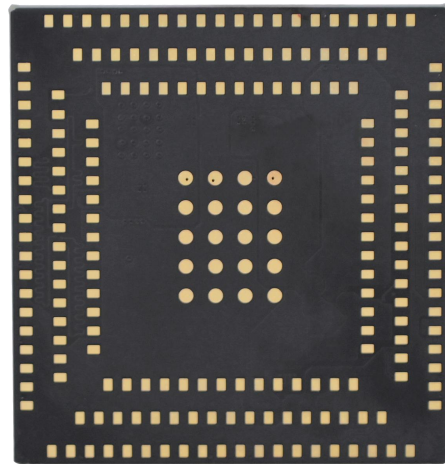

MYC-LMX9X System On Module (Top-view and Bottom-view)

Processor

- NXP i.MX 9352 processor
 - Up to 1.7GHz Dual-core ARM Cortex-A55 CPU
 - 250MHz Real-time ARM Cortex-M33 co-processor
 - Up to 0.5 TOPS Arm® Ethos™ U-65 microNPU

Memory

- 1GB/2GB LPDDR4
- 8GB eMMC
- 32KB EEPROM

Peripherals and Signals Routed to Pins

- Power Management IC (PCA9451AHNY)
- 218-pin LGA Expansion Interface
 - 2x RGMII
 - 2x USB2.0
 - 8x UART
 - 2x CAN FD
 - 8x I2C
 - 2x I3C
 - 8x SPI



- 1x MIPI-DSI
- 1x LVDS
- 1x RGB
- 1x MIPI-CSI
- 1x Parallel CSI
- 3x SAI
- 1x SPDIF
- 4x ADC
- 1x JTAG
- Up to 87x GPIOs

Note: the peripheral signals brought out to the expansion interface are listed in maximum number. Some signals are reused. Please refer to the processor datasheet and the SOM pinout description file.

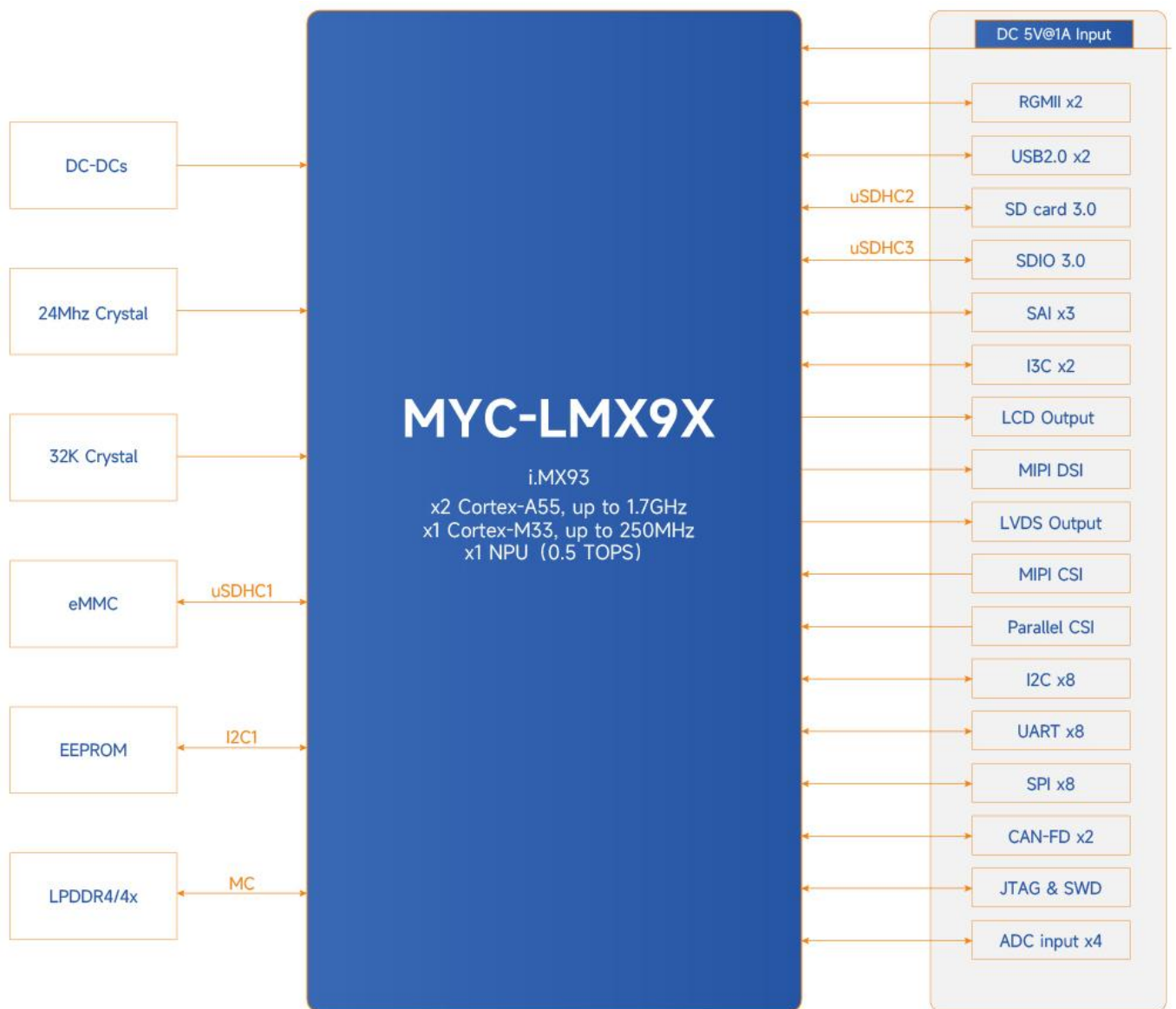

MYC-LMX9X Function Block Diagram



The MYD-LMX9X Development Board Base Board

- 1x Power Jack
- 1x Power Switch
- Serial Ports
 - 1x RS232
 - 1x RS485 (with isolation)
 - 3x Debug Interfaces (one for Cortex-A55 core, one for Cortex-M33 core, one for JTAG)
- USB
 - 2x USB2.0 Host ports
 - 1x USB2.0 OTG port
 - 1x M.2 socket for USB based 4G/5G LTE Module
- 2x SIM card slots
- 2x 10/100/1000Mbps Ethernet interfaces
- 1x WiFi Module
- 2x external antenna connectors (one for WiFi and one 4G/5G)
- 1x CAN FD interface (with isolation)
- 1x Micro SD card slot
- 1x LVDS interface (J21, 0.5mm pitch 40-pin FPC connector)
- 1x RGB Interface (J23, 0.5mm pitch 50-pin FPC connector)
- 1x HDMI Display Interface
- 1x MIPI-CSI Camera Interface (J20, 0.5mm pitch 24-pin FPC connectors)
- 1x Audio Input and Output Interface
- 3x Buttons (one for Reset, one for User, one for ON/OFF)

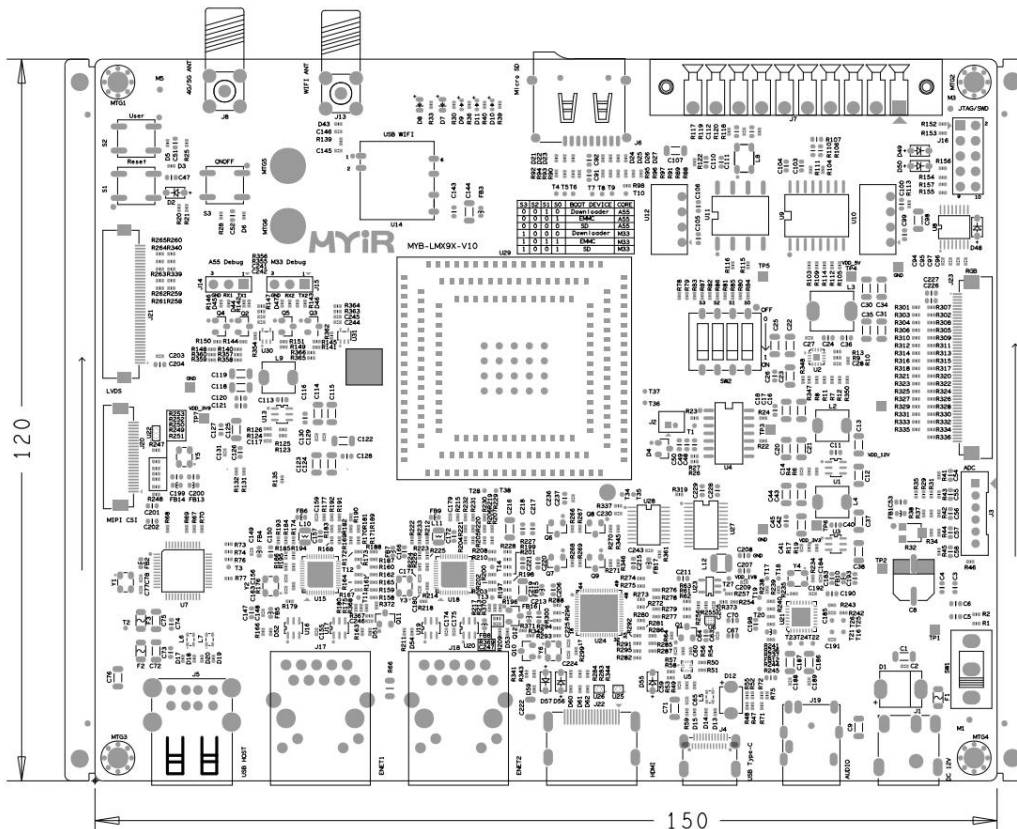

MYD-LMX9X Dimensions Chart (Unit: MM)



Software Features

The MYD-LMX9X development board supports Linux OS and comes equipped with comprehensive software packages. To help clients in accelerate their projects, the kernel and various peripheral drivers are provided in source code format. Here is a brief overview of the key software features:

Item	Features	Description	Source Code
Bootloader	ATF	First Bootloader Program ATF2.8	YES
	SPL	Second Bootloader Program SPL	YES
	U-boot	Third Bootloader Program uboot_2023.04	YES
Linux kernel	Linux kernel	Customized base on official kernel_6.1.36 version	YES
Device driver	PMIC	PCA9451AHNY driver	YES
	USB Host	USB Host driver	YES
	USB OTG	USB OTG driver	YES
	I2C	I2C bus driver	YES
	SPI	SPI bus driver	YES
	Ethernet	YT8531SH driver	YES
	SDHI	eMMC/SD card storage driver	YES
	HDMI	LT9611 driver	YES
	LVDS	LVDS driver	YES
	Audio	SGTL5000 driver	YES
	4G/5G	4G/5G driver	YES
	ADC	ADC driver	YES
	RTC	INS5T8025 driver	YES
	GPIO	GPIO driver	YES
	UART	RS232/RS485/TTL driver	YES
	CAN	CAN driver	YES
MIPI-CSI	MY-CAM003M camera module driver (OV5640)	YES	
WiFi	FG6131EUXX-00 driver	YES	
File system	myir-image-core	Image built in Yocto without GUI interface	YES
	myir-image-full	A fully functional image built with Yocto	YES

MYC-LMX9X Software Features

Order Information

Product Item	Part No.	Packing List
MYD-LMX9X Development Board	MYD-LMX9352-8E1D-170-I	<ul style="list-style-type: none"> ✓ One MYD-LMX9X Development Board (including MYC-LMX9X SOM) ✓ One USB to TTL cable ✓ One 12V/2A Power adapter ✓ One Quick Start Guide
	MYD-LMX9352-8E2D-170-I	
MYC-LMX9X System-On-Module	MYC-LMX9352-8E1D-170-I	Add-on Options <ul style="list-style-type: none"> ✓ One MYC-LMX9X SOM ✓ MY-LVDS070C 7-inch LVDS Module ✓ MY-LCD70TP-C 7-inch LCD Module ✓ MY-CAM003M Module
	MYC-LMX9352-8E2D-170-I	
MY-LVDS070C 7-inch LVDS Module	MY-LVDS070C	
MY-LCD70TP-C 7-inch LCD Module	MY-TFT070CV2	
MY-CAM003M Camera Module	MY-CAM003M	
<i>Note:</i> <ol style="list-style-type: none"> 1. One MYD-LMX9X Development Board includes one MYC-LMX9X SOM mounted on the base board. If you need more SOMs, you can order extra ones. 2. Bulk discounts are available. Please contact MYIR for inquiries. 3. We accept custom design based on the MYD-LMX9X, whether reducing, adding or modifying the existing hardware according to customer's requirement. 		

MYIR Electronics Limited

Headquarter Address: Room 04, 6th Floor, Building No.2, Fada Road, Yunli Smart Park, Bantian, Longgang District, Shenzhen, Guangdong, China 518129

Factory Address: Room 201, Block C, Shengjianli Industrial Park, Dafu Industrial Zone, Guanlan, Longhua District, Shenzhen, 518110, China

Website: www.myirtech.com

Email: sales@myirtech.com

Tel: +86-755-22984836