



SPECIFICATION SHEET

SPECIFICATION SHEET NO.	R0408- MDD2301000S0S1	
DATE	Apr. 08, 2024	
REVISION	A0	Updated With Most Recent Data - Official First Release
DESCRIPTION AND MAIN PARAMETRICS	<p>-20V P-Channel Enhancement Mode MOSFET, MDD Series, 3 pads MDD2301 Type, Case SOT-23 Drain-Source Voltage (V(BR)DSS): -20V Continuous Drain Current (Id): -3.0A Power Dissipation (Pd): 1.2W Max. Operating Temp. Range -50°C ~+150°C Package in Tape/Reel, 3000pcs/Reel RoHS III/REACH Compliant and Halogen Free (HF)</p>	
CUSTOMER		
CUSTOMER PART NO.		
CROSS REF. PART NO.		
ORIGINAL MFG/PART NO.	MDD/MDD2301	
PART CODE	MDD2301000S0S1	

VENDOR APPROVE			
Issued/Checked/Approved			
DATE: Apr. 08, 2024			

CUSTOMER APPROVE	
DATE:	

-20V P-CHANNEL ENHANCEMENT MODE MOSFET CASE SOT-23

MAIN FEATURE

- Trench FET Power MOSFET
- Surface Mount Package Ideally Suited for Automatic Insertion
- REACH/RoHS III Complaint and Halogen Free
- Cross Main Competitor Parts in Market



APPLICATION

- Load Switch for Portable Devices
- DC/DC Converter

PART CODE GUIDE

RFQ

[Request For Quotation](#)

MDD	2301	000S	0S1
1	2	3	4

1. MDD: SMD P-Channel Enhancement Mode MOSFET, MDD series, 3 pads, Case SOT-23
2. 2301: Specification code for MDD2301 type.
3. 000S: Internal Control Code, Custom letter A~Z, a-z or digits (0-9)
4. 0S1: Marking code for "S1" on the case surface

-20V P-CHANNEL ENHANCEMENT MODE MOSFET CASE SOT-23

DIMENSION (Unit: mm)

Image for reference

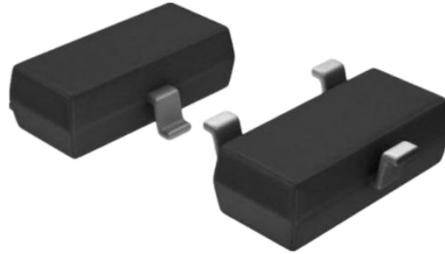

Case SOT-23 Outline

Symbol	Value (mm)		
	Min.	Typ.	Max.
A	0.90		1.4
A1	0.00		0.10
b	0.30		0.50
c	0.08		0.20
D	2.80	2.90	3.10
E	1.20		1.60
E1	2.25		2.80
e	1.80	1.90	2.00
L	0.10		0.50
L1	0.40		0.55
θ	0°		10°

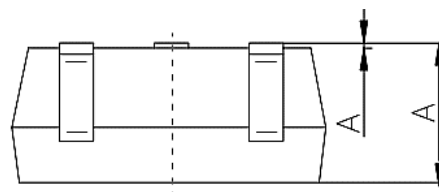
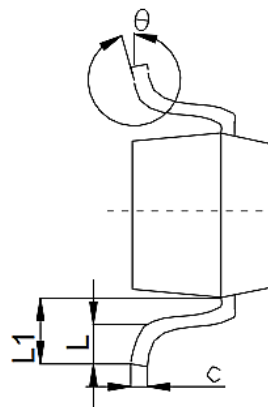
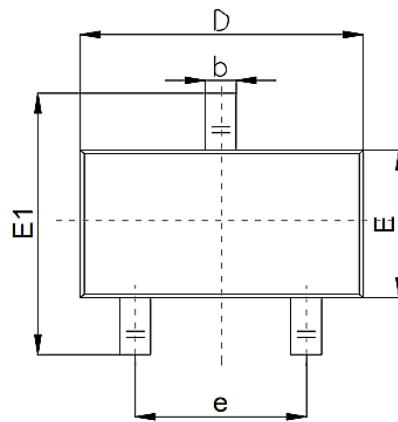

-20V P-CHANNEL ENHANCEMENT MODE MOSFET CASE SOT-23

EQUIVALENT CIRCUIT

1. Gate (G) 2. Source (S) 3. Drain (D)

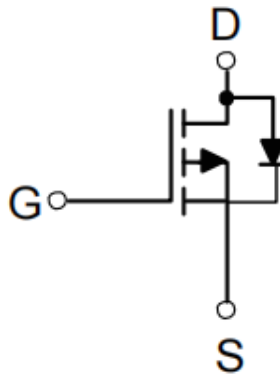
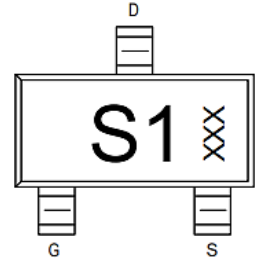
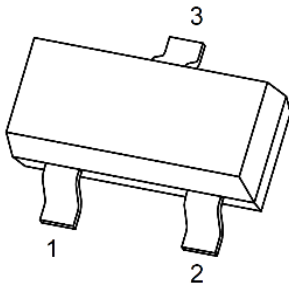

RECOMMEND PAD LAYOUT (For Reference, Unit: Inch/mm, ±0.05mm)

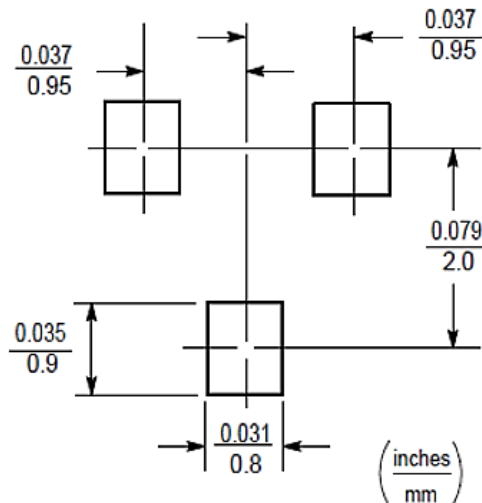

-20V P-CHANNEL ENHANCEMENT MODE MOSFET CASE SOT-23
-20V P-CHANNEL MODE MOSFET

V(BR)DSS	RDS(on) Typ.	Id Max.
-20V	70mΩ@4.5V	-3.0A
	95mΩ@2.5V	-3.0A

MECHANICAL DATA

CASE	TERMINAL	POLARITY	MOUNTING POSITION	WEIGHT PER PIECE
JEDEC SOT-23 molded plastic body	Matte tin plated	Polarity symbol marking on case	Any	0.00019 Ounce, 0.00591 grams

ABSOLUTE MAXIMUM RATINGS (AT Ta=25 °C , unless otherwise specified)

Parameter	SYMBOL	VALUE	UNITS
Drain-Source Voltage	Vds	-20	V
Gate-Source Voltage	Vgs	±12	V
Continuous Drain Current	Id	-3.0	A
Pulsed Drain Current (See Page 7 Note 1)	IDM	-12	A
Power Dissipation (See Page 7 Note 2)	PD	1.2	W
Thermal Resistance from Junction to Ambient (See Page 7 Note 2)	ReJA	100	°C/W
Junction Temperature and Storage Temperature	TJ , TSTG	-50 ~ +150	°C

Notes

Stresses exceeding Maximum Ratings may damage the device. Maximum Ratings are stress ratings only. Functional operation above the Recommended Operating Conditions is not implied. Extended exposure to stresses above the Recommended Operating Conditions may affect device reliability.

-20V P-CHANNEL ENHANCEMENT MODE MOSFET CASE SOT-23
MOSFET STATIC CHARACTERISTICS (AT Ta=25 °C unless otherwise specified)

PARAMETER	SYMBOL	VALUE			UNIT	CONDITION
		MIN.	TYP.	MAX.		
Drain-source Breakdown Voltage	V(BR)DSS	-20	-	-	V	VGS=0V, ID= 250µA
Drain-Source Leakage Current	IDSS	-	-	-1.0	µA	VDS= -20V, VGS=0V
Gate-Source Leakage Current	IGSS	-	-	±100	nA	VGS=±10V, VDS=0V
Gate threshold Voltage	VGS(TH)	-0.4	-0.7	-1.0	V	VDS= VGS, ID= -250µA
Drain-Source On-State Resistance (See Page 7 Note 3)	RDS(ON)	-	70	90	mΩ	VGS= -4.5V, ID= -3.0A
		-	95	130		VGS= -2.5V, ID= -2.0A

DYNAMIC ELECTRICAL CHARACTERISTICS (AT Ta=25 °C unless otherwise specified)

PARAMETER	SYMBOLS	VALUE			UNIT	CONDITION
		MIN.	TYP.	MAX.		
Input Capacitance	Ciss	-	330	-	pF	VDS= -10V VGS=0V f=1MHz
Output Capacitance	Coss	-	50	-	pF	
Reverse Transfer Capacitance	Crss	-	45	-	pF	
Total Gate Charge	Qg	-	6.6	-	nC	VDS= -10V VGS= -2.5V ID= -3.0A
Gate Source Charge	Qgs	-	0.7	-	nC	
Gate Drain Charge	Qgd	-	1.4	-	nC	

-20V P-CHANNEL ENHANCEMENT MODE MOSFET CASE SOT-23
SWITCHING CHARACTERISTICS (AT Ta=25 °C unless otherwise specified)

PARAMETER	SYMBOLS	VALUE			UNIT	CONDITION
		MIN.	TYP.	MAX.		
Turn on Delay Time	td(on)	-	11	-	ns	Vds=-10V VGS= -4.5V ID= -3.0A RG= 3.3Ω RL=10Ω
Turn on Rise Time	tr	-	12	-	ns	
Turn Off Delay Time	td(off)	-	18	-	ns	
Turn Off Fall Time	tf	-	30	-	ns	

SOURCE DRAIN DIODE CHARACTERISTICS (AT Ta=25 °C unless otherwise specified)

PARAMETER	SYMBOLS	VALUE			UNIT	CONDITION
		MIN.	TYP.	MAX.		
Source drain current (Body Diode)	ISD	-	-	-1.5	A	Ta=25 °C
Drain-Source Diode Forward Voltage	VSD	-	-0.85	-1.2	V	VGS=0V, IS= -2.0A

Notes

1. Pulse width limited by maximum allowable junction temperature
2. The value of Pd & RθJA is measured with the device mounted on 1 in² FR-4 board with 2oz. Copper, double sided, in a still air environment with Ta=25°C.
3. Pulse test: Pulse width ≤ 300μs, duty cycle ≤2%

-20V P-CHANNEL ENHANCEMENT MODE MOSFET CASE SOT-23

TYPICAL PERFORMANCE CHARACTERISTIC CURVES (For Reference Only)

Figure 1. Typical Output Characteristics

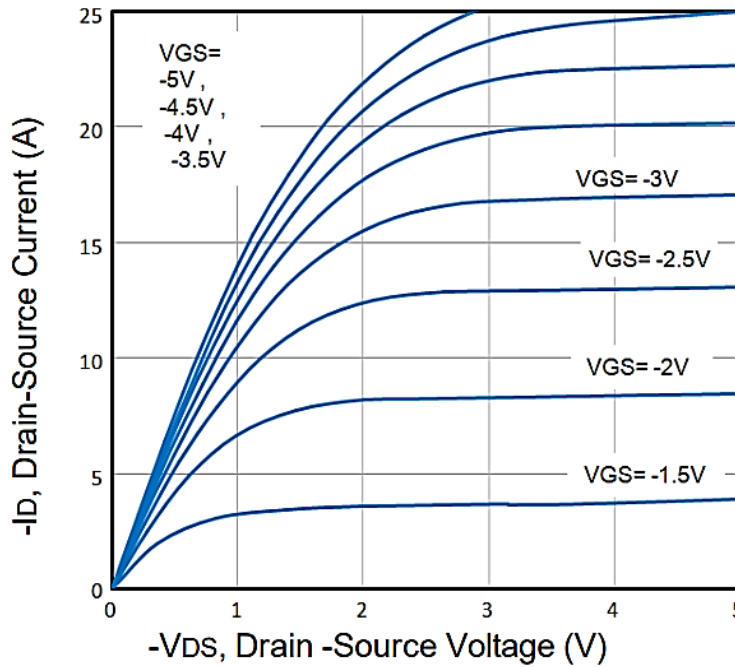
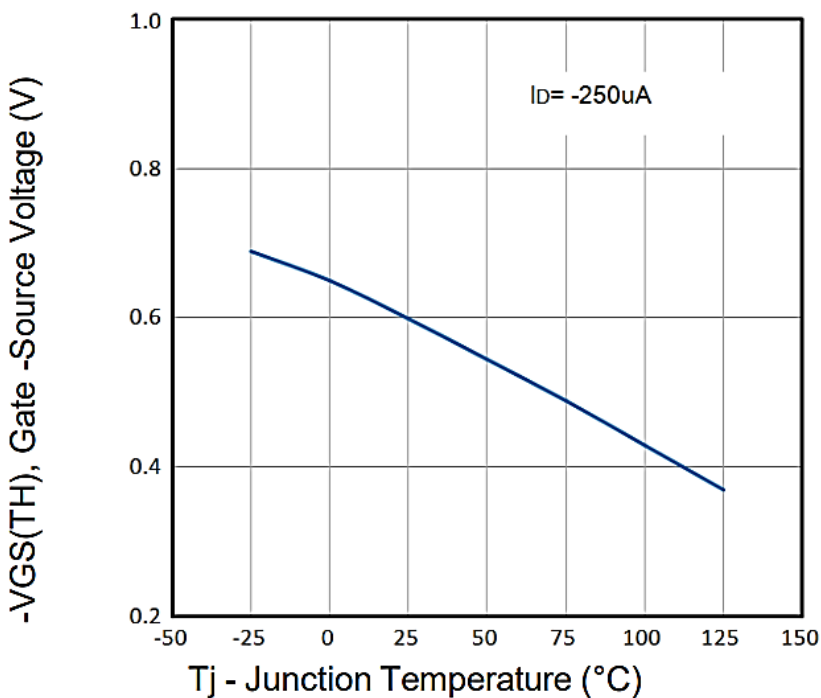

Figure 2. Normalized Threshold Voltage Vs. Temperature



-20V P-CHANNEL ENHANCEMENT MODE MOSFET CASE SOT-23

TYPICAL PERFORMANCE CHARACTERISTIC CURVES (For Reference Only)

Figure 3. Typical Transfer Characteristics

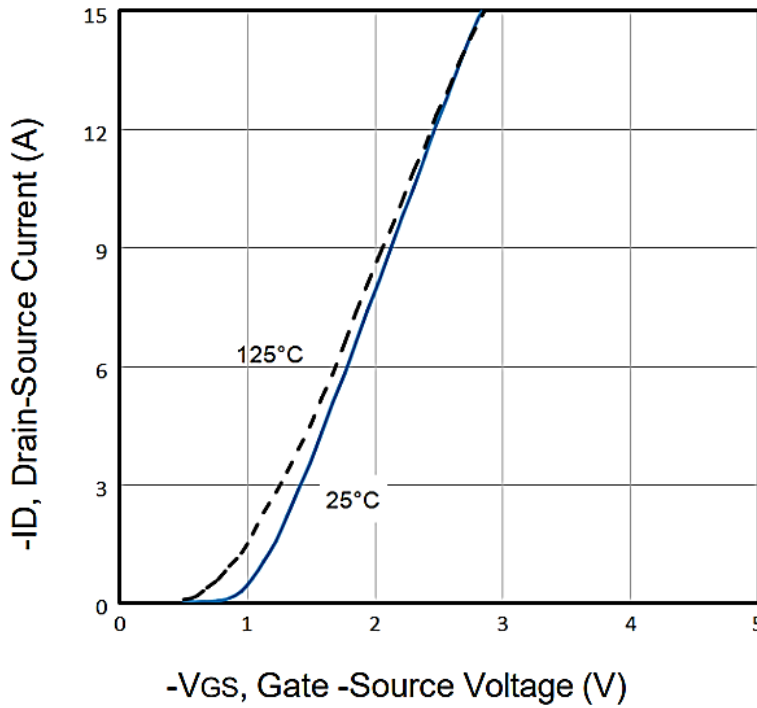
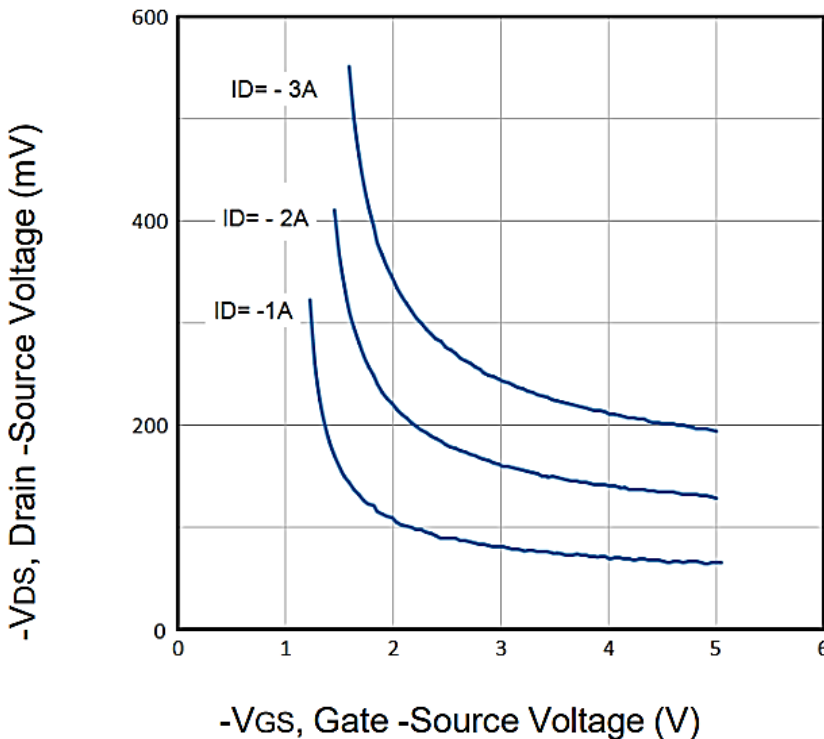

Figure 4. On-Resistance vs. Drain Current and Gate



-20V P-CHANNEL ENHANCEMENT MODE MOSFET CASE SOT-23

TYPICAL PERFORMANCE CHARACTERISTIC CURVES (For Reference Only)

Figure 5. Typical Source-Drain Diode Forward Voltage

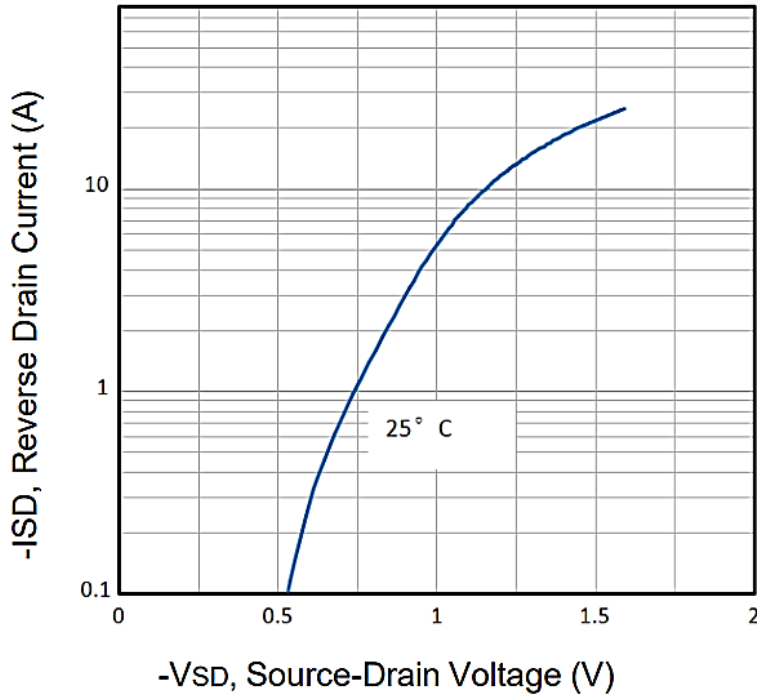
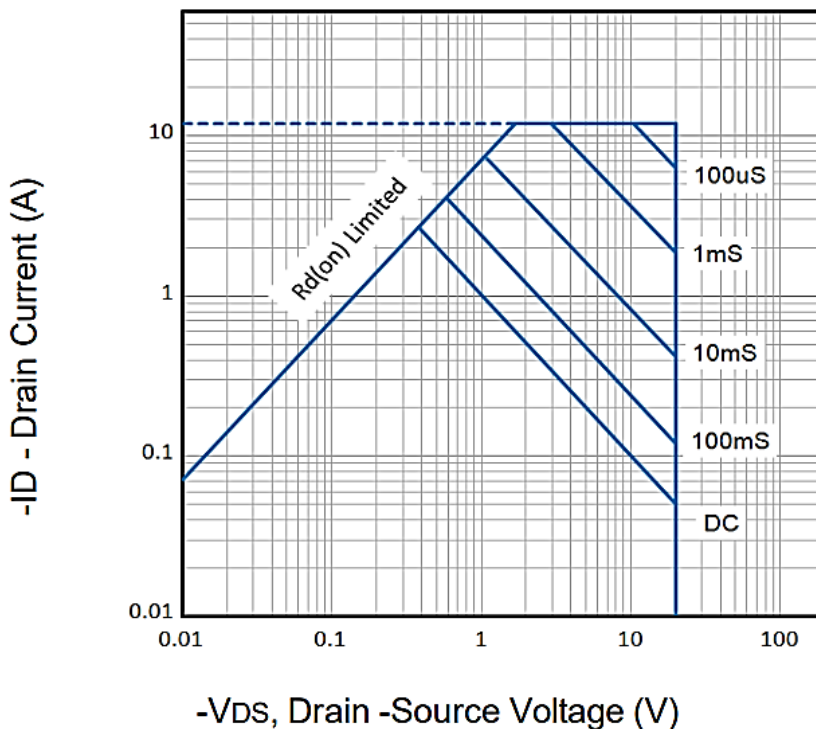

Figure 6. Maximum Safe Operating Area



-20V P-CHANNEL ENHANCEMENT MODE MOSFET CASE SOT-23

TYPICAL PERFORMANCE CHARACTERISTIC CURVES (For Reference Only)

Figure 7. Typical Capacitance Vs. Drain-Source Voltage

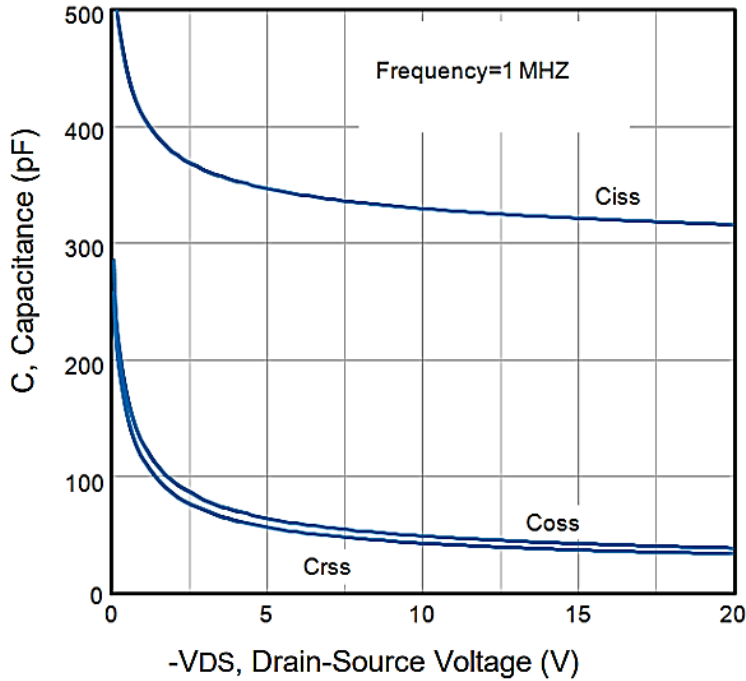
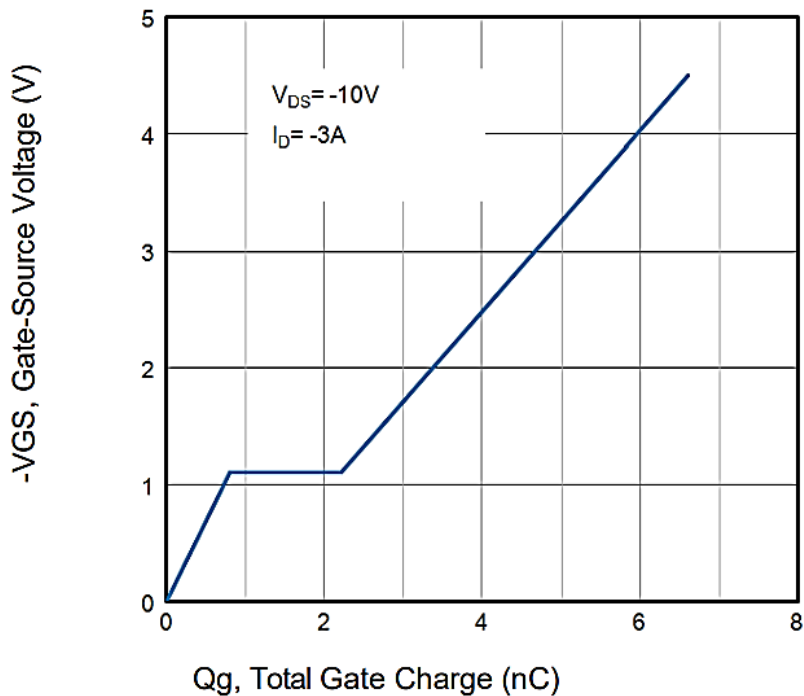

Figure 8. Typical Gate Charge Vs. Gate-Source Voltage



-20V P-CHANNEL ENHANCEMENT MODE MOSFET CASE SOT-23

TYPICAL PERFORMANCE CHARACTERISTIC CURVES (For Reference Only)

Figure 9. Normalized Maximum Transient Thermal Impedance

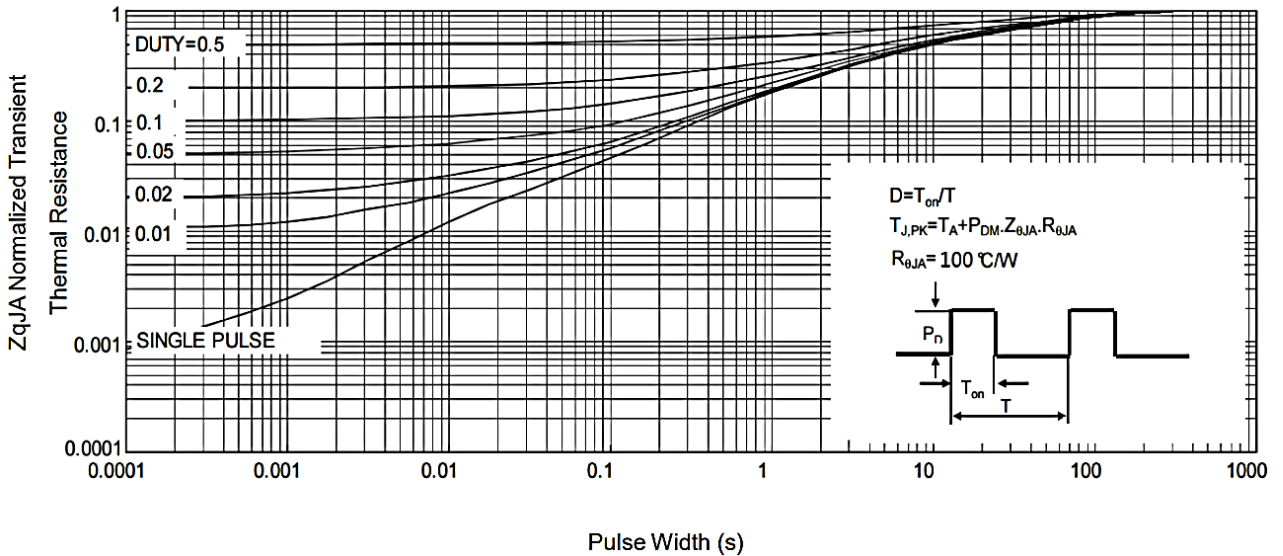
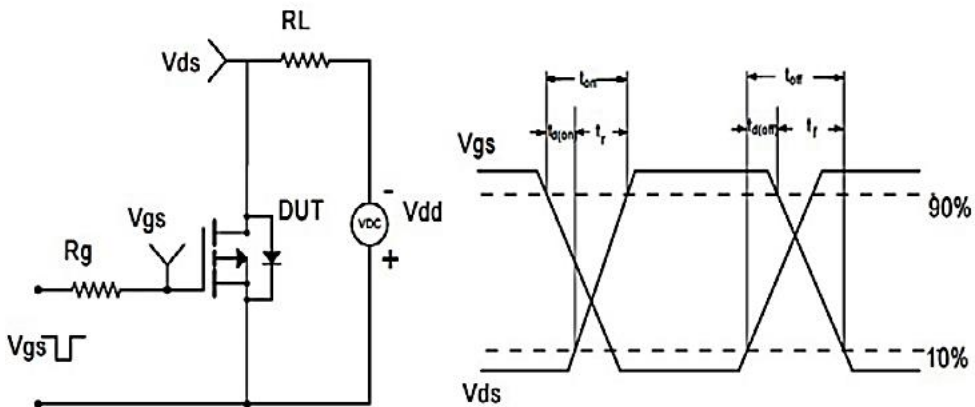

Figure 10. Switching Time Test Circuit and waveforms



-20V P-CHANNEL ENHANCEMENT MODE MOSFET CASE SOT-23
RELIABILITY

NUMBER	EXPERIMENT ITEMS	EXPERIMENT METHOD AND CONDITIONS	REFERENCE DOCUMENTS
1	Solder Resistance Test	Test 260°C± 5°C for 10 ± 2 sec. Immerse body into solder 1/16" ± 1/32"	MIL-STD-750D METHOD-2031.2
2	Solderability Test	230°C ±5°C for 5 sec.	MIL-STD-750D METHOD-2026.1 0
3	Pull Test	1 kg in axial lead direction for 10 sec.	MIL-STD-750D METHOD-2036.4
4	Bend Test	0.5Kg Weight Applied To Each Lead, Bending Arcs 90 °C ± 5 °C For 3 Times	MIL-STD-750D METHOD-2036.4
5	High Temperature Reverse Bias Test	TA=100°C for 1000 Hours at VR=80% Rated VR	MIL-STD-750D METHOD-1038.4
6	Forward Operation Life Test	TA=25°C Rated Average Rectified Current	MIL-STD-750D METHOD-1027.3
7	Intermittent Operation Life Test	On state: 5 min with rated IRMS Power Off state: 5 min with Cool Forced Air. On and off for 1000 cycles.	MIL-STD-750D METHOD-1036.3
8	Pressure Cooker Test	15 PSIG, TA=121°C, 4 hours	MIL-S-19500 APPENOIXC
9	Temperature Cycling Test	-55°C~+125°C; 30 Minutes For Dwelled Time 5 minutes for transferred time. Total: 10 cycles.	MIL-STD-750D METHOD-1051.7
10	Thermal Shock Test	0°C for 5 minutes., 100°C for 5minutes, Total: 10 cycles	MIL-STD-750D METHOD-1056.7
11	Forward Surge Test	8.3ms Single Sale Sine-wave One Surge.	MIL-STD-750D METHOD-4066.4
12	Humidity Test	TA=65°C, RH=98% for 1000 hours.	MIL-STD-750D METHOD-1021.3
13	High Temperature Storage life Test	150°C for 1000 Hours	MIL-STD-750D METHOD-1031.5

-20V P-CHANNEL ENHANCEMENT MODE MOSFET CASE SOT-23

SUGGESTED REFLOW PROFILE - For Reference Only

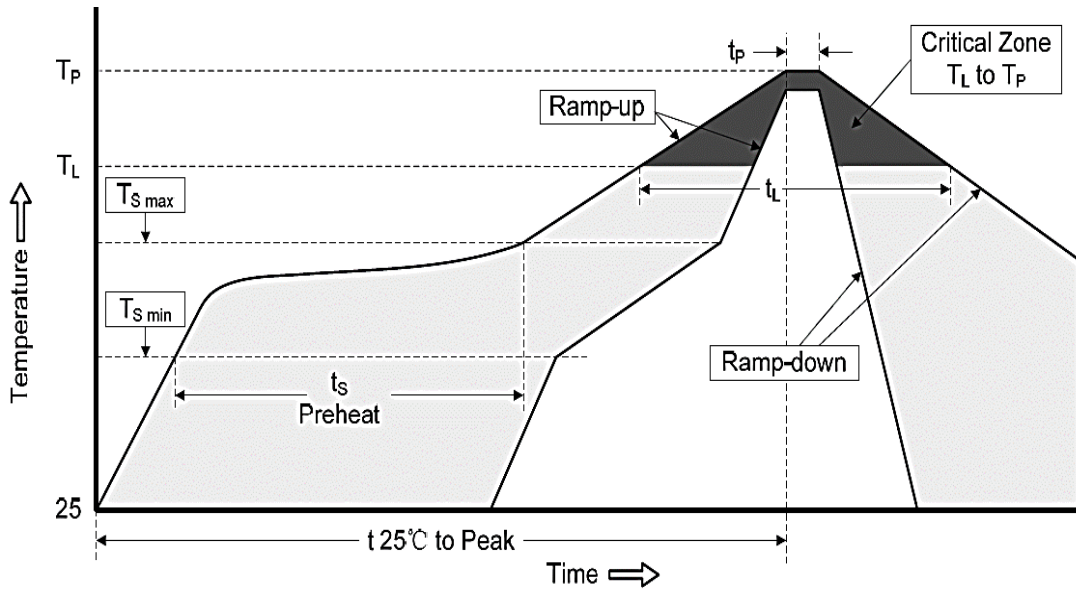

PROFILE FEATURE		PB-FREE ASSEMBLY
Average Ramp-up Rate (Ts Max to Tp)		3°C/second Max
Preheat	Temperature Min (Ts Min.)	150°C
	Temperature Max (Ts Max.)	200°C
	Time (ts Min. to ts Max.)	60 ~ 180 seconds
Time maintained above	Temperature (Tl)	217°C
	Time (tl)	60 ~ 150 seconds
Peak/Classification Temperature (Tp)		260 °C
Time within 5°C of actual Peak Temperature (tp)		20 ~ 40 seconds
Ramp-down rate		6 °C /Second Max.
Time 25 °C to Peak Temperature		8 minutes Max.
Suggest reflow times		3 Times Max.

-20V P-CHANNEL ENHANCEMENT MODE MOSFET CASE SOT-23

TAPE/REEL (Unit: mm)

All Devices are packed in accordance with EIA standard RS-481-A and specifications.

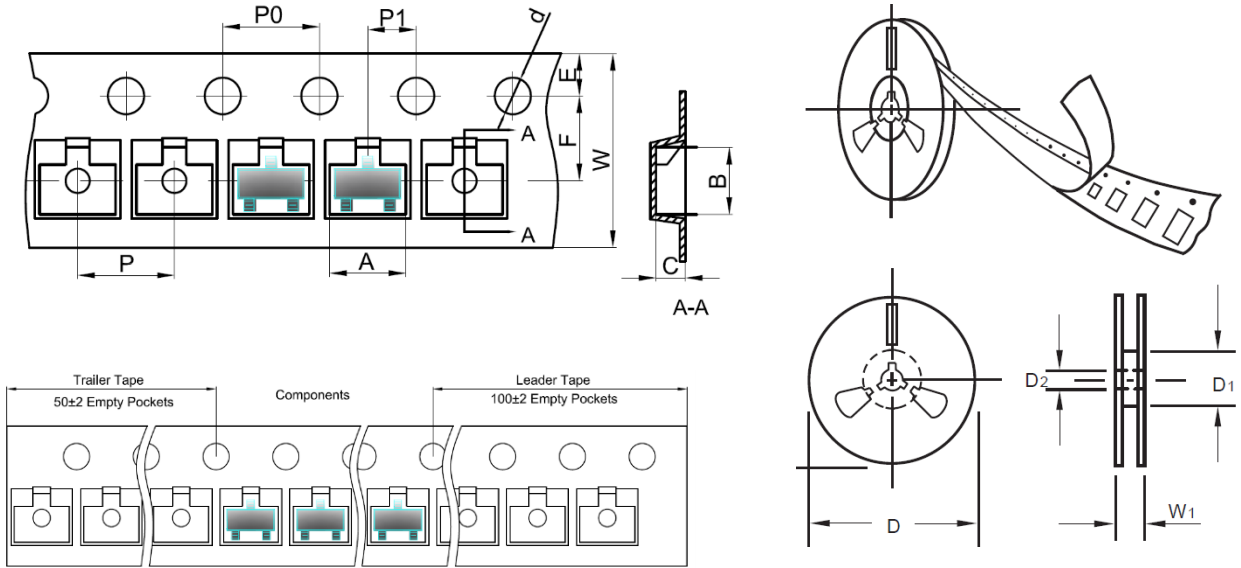

ITEM	SYMBOL	TOLERANCE	SOT-23
Carrier width	A	0.1	3.15
Carrier Length	B	0.1	2.77
Carrier Depth	C	0.1	1.22
Sprocket hole	d	0.05	1.55
7"Reel outside diameter	D	2.0	178.00
7"Reel inner diameter	D1	Min.	54.4
Feed hole diameter	D2	0.5	13.00
Sprocket hole position	E	0.1	1.75
Punch hole position	F	0.1	3.50
Punch hole pitch	P	0.1	4.00
Sprocket hole pitch	P0	0.1	4.00
Embossment center	P1	0.1	2.00
Overall tape thickness	T	0.1	0.25
Tape width	W	0.3	8.00
Reel width	W1	1.0	19.50
Qty. per Reel		3000pcs	

-20V P-CHANNEL ENHANCEMENT MODE MOSFET CASE SOT-23

ROHS COMPLIANCE

- The levels of RoHS restricted materials in this product are below the maximum concentration values (also referred to as the threshold limits) permitted for such substances, or are used in an exempted application, in accordance with EU RoHS Directive (EU) 2015/863 EC (RoHS3). RoHS Test Report for this product can be obtained can be obtained at Download Center.

REACH COMPLIANCE

- REACH substances of high concern (SVHCs) information is available for this product. Since the European Chemical Agency (ECHA) has published notice of their intent to frequently revise the SVHC listing for the foreseeable future, REACH Test Report for this product can be obtained can be obtained at Download Center.

IMPORTANT NOTES AND DISCLAIMER

1. All Product parametric performance is indicated in the Electrical Characteristics for the listed herein test conditions, unless otherwise noted. Product performance may not be indicated by the Electrical Characteristics if operated under different conditions.
2. NextGen Component, Inc (*NextGen*) reserves the right to make changes to this document and its products and specifications at any time without notice. Customers should obtain and confirm the latest product information and specifications before final design, purchase or use.
3. *NextGen* makes no warranty, representation or guarantee regarding the suitability of its products for any particular purpose, not does NextGen assume any liability for application assistance or customer product design.
4. *NextGen* does not warrant or accept any liability with products which are purchased or used for any unintended or unauthorized application. No license is granted by implication or otherwise under any intellectual property rights of NextGen.
5. *NextGen* products are not authorized for use as critical components in life support devices or systems without express written approval by *NextGen*.
6. *NextGen* requires that customers first obtain an RMA (Returned Merchandise Authorization) number prior to returning any products. Returns must be made within 30 days of the date of invoice, be in the original packaging, unused and like-new condition. At the time of quoting or purchasing, a product may say that it is Non-Cancelable/ Non-Returnable (NCNR). These products are not returnable and not refundable.