

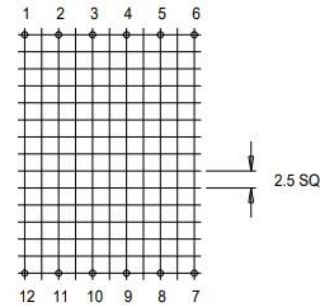

FE0230

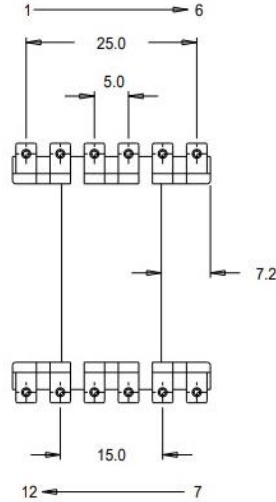
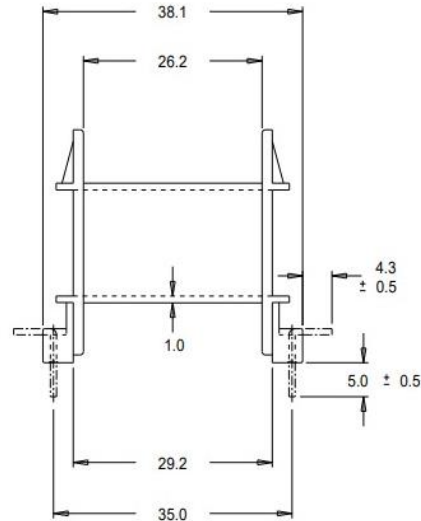
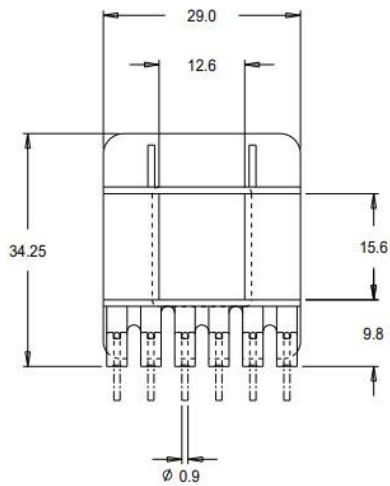

Part Number FE0230	Part Weight (g) 7.3	Carton Quantity 420	Pinning Configuration TPB-RD-090 1:2:3:4:5:6:7:8:9:10:11:12:
Order Code FE0230FGNNAT0001	Material Nylon PA66	Carton Size (mm) 465x315x260	Pin Length (mm) (from standoff) 5.0
Part Description Bobbin E42/21/15 H 12P 1S UL94V0	Material Datasheets	Related Items n/a	Terminal Pin Material Phosphor Bronze
Product Range E/EF Range	UL Rating UL94V0	3D CAD Image	Compliance information

MILES - PLATTS

+44 (0)116 264 3850

milesplatts.co.uk

enquiries@milesplatts.co.uk