

E4-42  
H4-42  
R4-42



# e-chain system® E4-1

## Series E4-42/H4-42/R4-42

### Price Index



Series E4-42



Series H4-42



Series R4-42

### Special Options Available



Low noise version available with special rubber pads



Cleanroom test upon request



ESD classification:  
Electrically conductive ESD/  
ATEX version upon request

### Assembly Tips



Opening e-chains®: Remove crossbars and clips - Insert screwdriver into the slot, push down, release by lever action



Remove lids/bottoms (e-tubes) - Insert screwdriver into the slot, release by lever action

### Other Installation Methods

Vertical, hanging ≤ 328 ft (100 m)

Vertical, standing ≤ 19.69 ft (6 m)

Side-mounted, un\_supp. ≤ 6.56 ft (2 m)

Rotary requires further calculation

### Usage Guidelines



- If quiet operation is required
- If very high speeds and/or accelerations are required
- Long travels
- High additional loads



- When an extremely low vibration e-chain®/e-tube is required  
➤ Series E6-40/R6-40
- When an economic one-sided snap-open e-chain®/e-tube is required  
➤ Series 3400/3450/3480/3500

### Features & Benefits

- 1 Wide, rounded plastic crossbars - cable friendly
- 2 Low-noise operation through integrated brake in the radial stop dog system
- 3 Hinged snap-open removable lids along the outer radius of the e-tube
- 4 Straight run through inner-/outer-link design
- 5 QuickLock Crossbar, 385-X-Q, available for faster assembly/disassembly
- 6 The tongue and groove design provides greater lateral stability
- 7 New Interior separation kit available
- 8 Crossbars are removable along both radii
- 9 15% more tensile strength (compared to the older E4 series), better unsupported length through improved stop dog system and vertical radial stops
- 10 Version NCST "without camber" simply by turning outer links without unnecessary rework



Also available without camber.  
Add NCST to the end of the part number.  
Ex: E4-42-20-300NCST

### Order Example: Complete e-chain®

Please indicate chain length or number of links. Example:

16.4 ft (5 m) E4-42-20-300-0

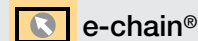

e-chain®

With 2 separators 42.1.1 assembled every 2nd link



Interior Separation

1 Set E4-420-20-12P



Mounting Bracket

# e-chain system® E4-1

## Series E4-42/H4-42/R4-42

### Installation Dimensions



E4-42  
H4-42  
R4-42

#### Short travel, unsupported length

- $FL_B$  = unsupported with permitted sag
  - $FL_G$  = unsupported with straight upper run
- Further information ► Design, Chapter 1

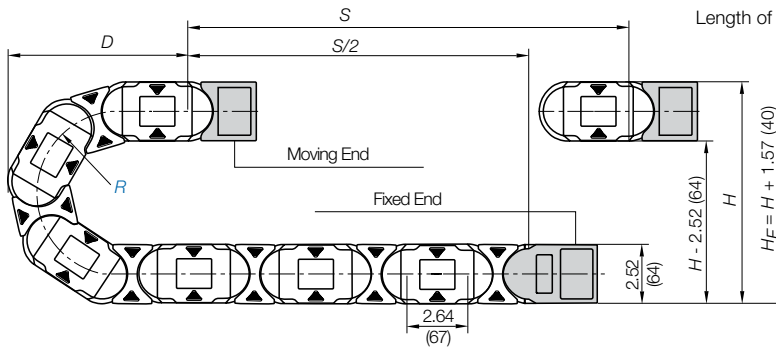
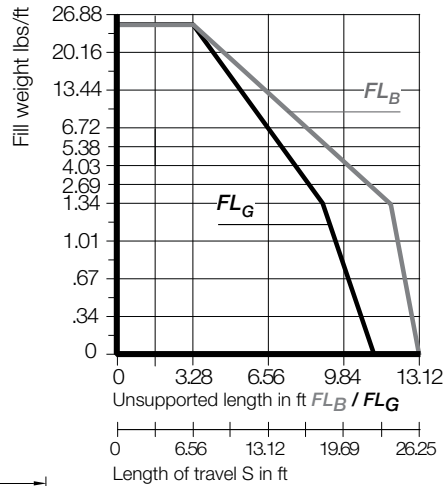
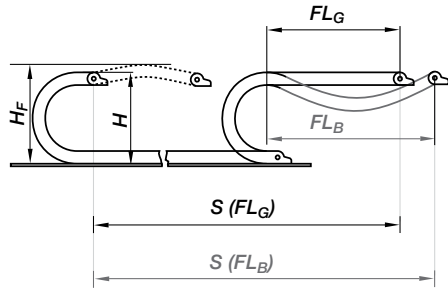

Pitch per link = 2.64" (67 mm)  
Links per ft (m) = 4.57 (15)  
For center mount applications:  
Chain length =  $\frac{S}{2} + K$

The required clearance height:  $H_F = H + 1.57$  in. (40 mm) (with 2.02 lbs/ft (3 kg/m) fill weight).  
Please consult igus® if space is particularly restricted.

R	2.95 (075*)	3.94 (100*)	4.53 (115*)	4.92 (125)	5.91 (150)	6.30 (160)	6.69 (175)	7.87 (200)	9.84 (250)	11.81 (300)	13.78 (350)
H $\pm 0.25$	8.43 (214)	10.39 (264)	11.57 (294)	12.36 (314)	14.33 (364)	15.12 (384)	16.30 (414)	18.27 (464)	22.20 (564)	26.14 (664)	30.08 (764)
D	8.19 (208)	9.17 (233)	9.76 (248)	10.15 (258)	11.14 (283)	11.54 (293)	12.13 (308)	13.11 (333)	15.08 (383)	17.05 (433)	19.02 (483)
K	14.57 (370)	17.72 (450)	19.69 (500)	20.87 (530)	24.02 (610)	25.20 (640)	26.97 (685)	30.12 (765)	36.22 (920)	42.52 (1080)	48.62 (1235)

\*Radius not available for e-tubes

#### For long travels with lowered mounting height

Long travel lengths from 32.8 ft. (10 m) to max. 984 ft. (300 m)

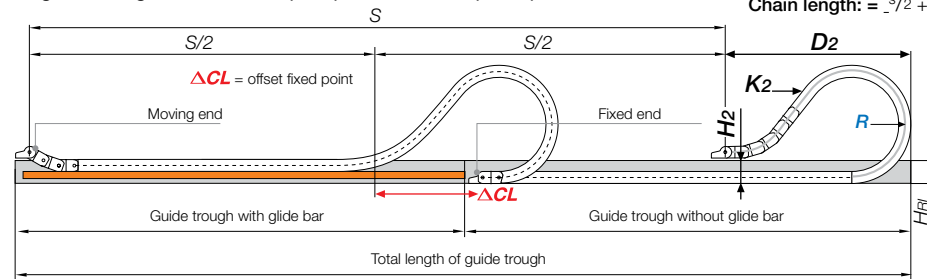

R	2.95 (075*)	3.94 (100*)	4.53 (115*)	4.92 (125)	5.91 (150)	6.30 (160)	6.69 (175)	7.87 (200)	9.84 (250)	11.81 (300)	13.78 (350)
H <sub>2</sub>	-	-	9.06 (230)	7.32 (186)	7.32 (186)	7.32 (186)	7.32 (186)	7.32 (186)	7.32 (186)	7.32 (186)	7.32 (186)
D <sub>2</sub> $\pm 25$	-	-	17.13 (435)	18.70 (475)	22.44 (570)	24.53 (623)	26.38 (670)	30.71 (780)	40.55 (1030)	45.28 (1150)	59.06 (1500)
K <sub>2</sub>	-	-	29.02 (737)	31.65 (804)	36.93 (938)	42.20 (1072)	44.84 (1139)	52.76 (1340)	65.94 (1675)	76.50 (1943)	94.96 (2412)
ΔCL	-	-	7.87 (200)	9.06 (230)	11.81 (300)	14.96 (380)	14.96 (380)	18.11 (460)	25.98 (660)	28.74 (730)	40.55 (1030)

In case of travels between 26.3 and 29.4 ft (8 and 12 m) we recommend a longer unsupported length.

For support of the lower run, see Chapter 9 for the Support Tray tool kit

\*Radius not available for e-tubes

#### Short Travels - Unsupported

Unsupported e-chains® feature positive camber over short travels. This must be accounted for when specifying the clearance height. Please refer to **Installation dimensions** for further details.

#### Legend

- S = Length of travel
- R = Bending radius
- H = Nominal clearance height
- D = Overlength e-chain® radius in final position
- K =  $\pi \cdot R + \text{ safety buffer}$
- H<sub>F</sub> = Required clearance height
- H<sub>ri</sub> = Trough inner height
- H<sub>2</sub> = \*Mounting height
- D<sub>2</sub> = Overlength - long travels, gliding
- K<sub>2</sub> = \*Add-on

\*If the mounting bracket location is set lower

#### Long Travels - Gliding



If the unsupported length is exceeded, the e-chain®/ Tube must glide on itself. This requires a guide trough.

Design, Chapter 1

#### Technical Data

Speed / acceleration $FL_G$	max. 65.6 ft/s (20 m/s) / max. 656 ft/s <sup>2</sup> (200 m/s <sup>2</sup> )
Speed / acceleration $FL_B$	max. 9.84 ft/s (3 m/s) / max. 19.69 ft/s <sup>2</sup> (6 m/s <sup>2</sup> )
Gliding speed / acceleration (maximum)	max. 32.8 ft/s (10 m/s) / max. 164 ft/s <sup>2</sup> (50 m/s <sup>2</sup> )
Material - permitted temperature	igumid G / -40°F (-40°C) up to +248°F (+120°C)
Flammability Class, igumid G	VDE 0304 IIC UL94 HB



Details of material properties

► Chapter 1



PDF: [igus.com/e-chain-pdfs](http://igus.com/e-chain-pdfs)  
Product information: [igus.com/e-chains](http://igus.com/e-chains)



Series E4-42 - e-chain® with crossbars every link

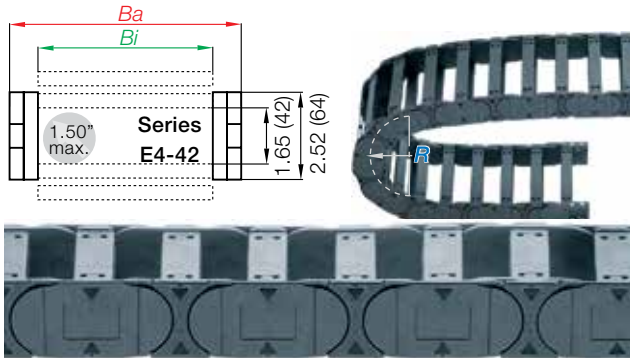

- Crossbars every link
- For use with rigid hydraulic hoses
- For particularly demanding applications
- Can be opened from both sides

Part Number Structure

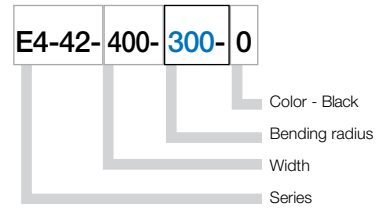

Series H4-42 - e-chain® with crossbars every other link

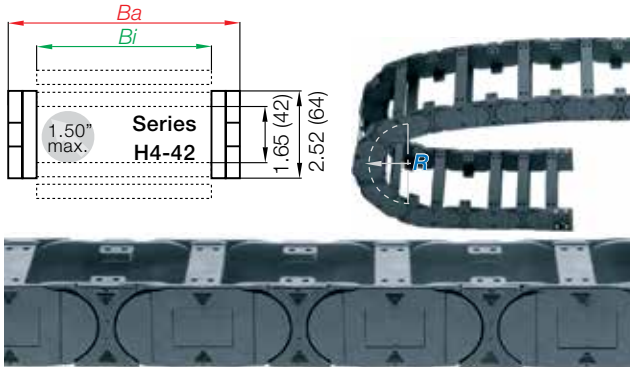

- Crossbars every other link
- Standard configuration
- For nearly every situation
- Can be opened from both sides
- Easy assembly
- Stable
- Cost-effective

Part Number Structure

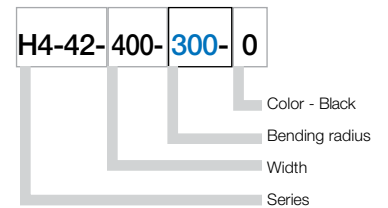

Series R4-42 - fully enclosed e-tube

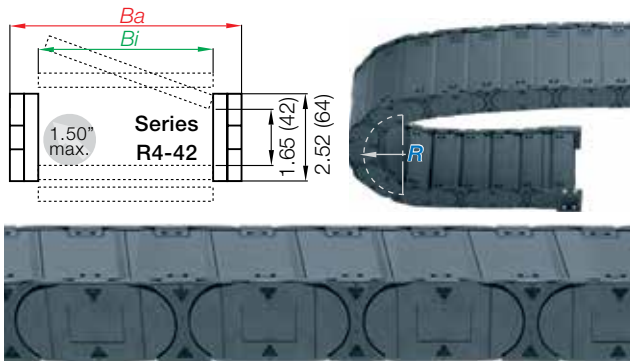

- Fully enclosed
- Excellent cable and hose protection against dirt
- Protection against hot chips
- Lids along inner radius are completely removable
- Lids along the outer radius are single-sided, snap open, hinged on one side as well as completely removable

Part Number Structure

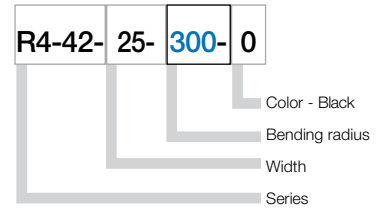

e-chain® as separate parts, links and side plates

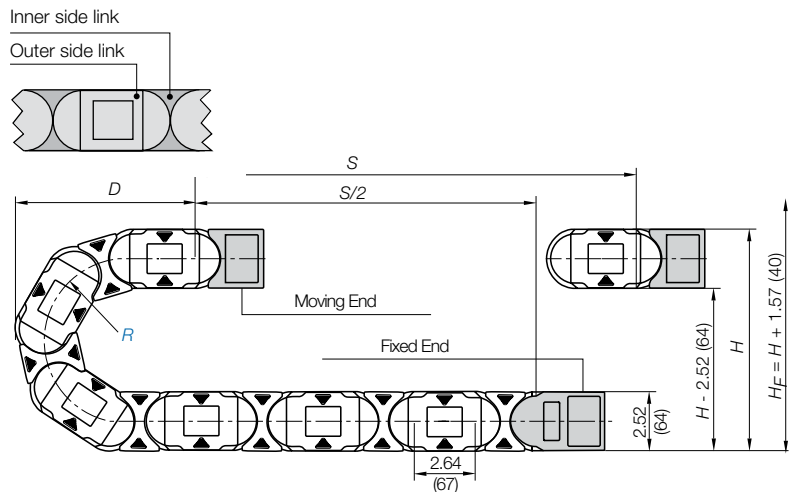
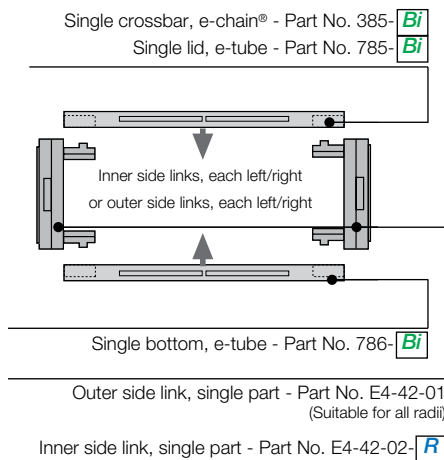

# e-chain system® E4-1

## Series E4-42/H4-42/R4-42

### Product Range



E4-42  
H4-42  
R4-42

Supplement part number with required radius. Example: E4-42-400-300-0  
Pitch: 2.64 in. (67mm) per link, links/ft(m) = 4.57 (15)

Part Number			<i>Bi</i>	<i>Ba</i>	Weight		
Crossbars Every link	Crossbars Every other	Tube Version			in. (mm)	in. (mm)	E4-42 lbs/ft (kg/m)
E4-42-05-	H4-42-05-	*R4-42-05- <input type="checkbox"/> -0	1.97 (50)	2.99 (76)	≈ 1.29 (1.92)	≈ 1.21 (1.80)	≈ 1.44 (2.15)
E4-42-06-	H4-42-06-	<input type="checkbox"/> -0	2.68 (68)	3.70 (94)	≈ 1.36 (2.03)	≈ 1.25 (1.86)	–
E4-42-07-	H4-42-07-	R4-42-07- <input type="checkbox"/> -0	2.95 (75)	3.98 (101)	≈ 1.38 (2.06)	≈ 1.26 (1.87)	≈ 1.53 (2.28)
E4-42-087-	H4-42-087-	<input type="checkbox"/> -0	3.43 (87)	4.49 (114)	≈ 1.42 (2.12)	≈ 1.28 (1.90)	≈ 1.62 (2.41)
E4-42-097	H4-42-097	<input type="checkbox"/> -0	3.82 (97)	4.72 (120)	≈ 1.43 (2.14)	≈ 1.29 (1.92)	–
E4-42-10-	H4-42-10-	R4-42-10- <input type="checkbox"/> -0	3.94 (100)	4.96 (126)	≈ 1.47 (2.19)	≈ 1.32 (1.96)	≈ 1.69 (2.52)
E4-42-11-	H4-42-11-	R4-42-11- <input type="checkbox"/> -0	4.25 (108)	5.28 (134)	≈ 1.50 (2.24)	≈ 1.32 (1.97)	≈ 1.73 (2.57)
E4-42-112-	H4-42-112-	<input type="checkbox"/> -0	4.41(112)	5.47 (139)	≈ 1.51 (2.25)	≈ 1.32 (1.97)	–
E4-42-12-	H4-42-12-	R4-42-12- <input type="checkbox"/> -0	4.92 (125)	5.94 (151)	≈ 1.57 (2.34)	≈ 1.35 (2.01)	≈ 1.83 (2.73)
E4-42-137-	H4-42-137-	<input type="checkbox"/> -0	5.39 (137)	6.46 (164)	≈ 1.61 (2.39)	≈ 1.37 (2.04)	–
E4-42-15-	H4-42-15-	R4-42-15- <input type="checkbox"/> -0	5.91 (150)	6.93 (176)	≈ 1.65 (2.46)	≈ 1.39 (2.07)	≈ 2.00 (2.98)
E4-42-162-	H4-42-162-	<input type="checkbox"/> -0	6.38 (162)	7.44 (189)	≈ 1.67 (2.48)	≈ 1.40 (2.09)	–
E4-42-17-	H4-42-17-	R4-42-17- <input type="checkbox"/> -0	6.61 (168)	7.64 (194)	≈ 1.71 (2.55)	≈ 1.42 (2.12)	≈ 2.12 (3.15)
E4-42-18-	H4-42-18-	<input type="checkbox"/> -0	6.89 (175)	7.91 (201)	≈ 1.73 (2.57)	≈ 1.43 (2.13)	–
E4-42-187-	H4-42-187-	<input type="checkbox"/> -0	7.36 (187)	8.43 (214)	≈ 1.75 (2.61)	≈ 1.44 (2.15)	–
E4-42-20-	H4-42-20-	R4-42-20- <input type="checkbox"/> -0	7.87 (200)	8.90 (226)	≈ 1.83 (2.72)	≈ 1.48 (2.20)	≈ 2.32 (3.45)
E4-42-212-	H4-42-212-	<input type="checkbox"/> -0	8.35 (212)	9.41 (239)	≈ 1.85 (2.76)	≈ 1.49 (2.22)	–
E4-42-23-	H4-42-23-	<input type="checkbox"/> -0	8.86 (225)	9.88 (251)	≈ 1.90 (2.84)	≈ 1.52 (2.26)	–
E4-42-237-	H4-42-237-	<input type="checkbox"/> -0	9.33 (237)	10.39 (264)	≈ 1.93 (2.87)	≈ 1.53 (2.28)	–
E4-42-25-	H4-42-25-	R4-42-25- <input type="checkbox"/> -0	9.84 (250)	10.87 (276)	≈ 2.00 (2.98)	≈ 1.57 (2.33)	≈ 2.86 (4.25)
E4-42-262-	H4-42-262-	<input type="checkbox"/> -0	10.31 (262)	11.38 (289)	≈ 2.05 (3.05)	≈ 1.59 (2.37)	–
E4-42-28	H4-42-28-	<input type="checkbox"/> -0	10.83 (275)	11.85 (301)	≈ 2.09 (3.11)	≈ 1.61 (2.40)	–
E4-42-29-	H4-42-29-	<input type="checkbox"/> -0	11.30 (287)	12.36 (314)	≈ 2.11 (3.14)	≈ 1.62 (2.41)	–
E4-42-30-	H4-42-30-	R4-42-30- <input type="checkbox"/> -0	11.81 (300)	12.83 (326)	≈ 2.18 (3.24)	≈ 1.65 (2.46)	≈ 3.29 (4.89)
E4-42-312-	H4-42-312-	<input type="checkbox"/> -0	12.28 (312)	13.35 (339)	≈ 2.19 (3.26)	≈ 1.66 (2.47)	–
E4-42-325-	H4-42-325-	<input type="checkbox"/> -0	12.79 (325)	13.82 (351)	≈ 2.24 (3.34)	≈ 1.69 (2.52)	–
E4-42-337-	H4-42-337-	<input type="checkbox"/> -0	13.27 (337)	14.33 (364)	≈ 2.28 (3.40)	≈ 1.71 (2.54)	–
E4-42-350-	H4-42-350-	<input type="checkbox"/> -0	13.78 (350)	14.80 (376)	≈ 2.41 (3.59)	≈ 1.77 (2.64)	–
E4-42-362-	H4-42-362-	<input type="checkbox"/> -0	14.25 (362)	15.31 (389)	≈ 2.47 (3.67)	≈ 1.80 (2.68)	–
E4-42-375-	H4-42-375-	<input type="checkbox"/> -0	14.76 (375)	15.83 (402)	≈ 2.51 (3.73)	≈ 1.82 (2.71)	–
E4-42-387-	H4-42-387-	<input type="checkbox"/> -0	15.24 (387)	16.30 (414)	≈ 2.55 (3.79)	≈ 1.84 (2.74)	–
E4-42-400	H4-42-400-	<input type="checkbox"/> -0	15.75 (400)	16.77 (426)	≈ 2.58 (3.84)	≈ 1.85 (2.76)	–

Choose from the radii below for all of the above sizes

Radius (mm) Example: E4-42-400-300-0

	075**	100**	115**	125	150	160	175	200	250	300	350
<i>R</i>	2.95 (075*)	3.94 (100*)	4.53 (115*)	4.92 (125)	5.91 (150)	6.30 (160)	6.69 (175)	7.87 (200)	9.84 (250)	11.81 (300)	13.78 (350)
<i>H</i> $\frac{D}{20}$	8.43 (214)	10.39 (264)	11.57 (294)	12.36 (314)	14.33 (364)	15.12 (384)	16.30 (414)	18.27 (464)	22.20 (564)	26.14 (664)	30.08 (764)
<i>D</i>	8.19 (208)	9.17 (233)	9.76 (248)	10.15 (258)	11.14 (283)	11.54 (293)	12.13 (308)	13.11 (333)	15.08 (383)	17.05 (433)	19.02 (483)
<i>K</i>	14.57 (370)	17.72 (450)	19.69 (500)	20.87 (530)	24.02 (610)	25.20 (640)	26.97 (685)	30.12 (765)	36.22 (920)	42.52 (1080)	48.62 (1235)

\*\* This radius is not available for the R4-42 Series

\*Removable lid only, no hinged option

0 = Standard color black.

For other colors see Chapter 1

For wider chains see page 6.51

For large diameter hoses see page 6.52

PDF: [igus.com/e-chain-pdfs](http://igus.com/e-chain-pdfs)  
Product information: [igus.com/e-chains](http://igus.com/e-chains)





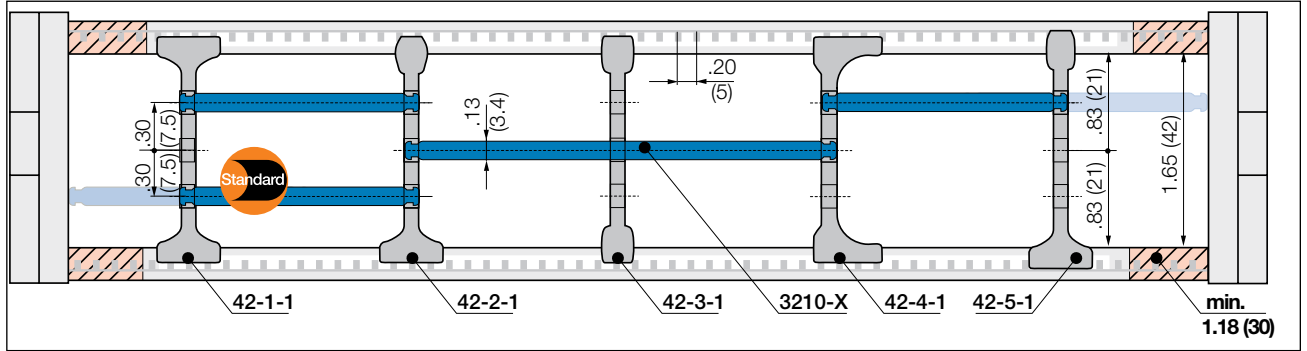

Note e-tube: Please maintain a lateral spacing of 1.18" (30 mm) between the separators and the side links. In the standard configuration separators are assembled every 2<sup>nd</sup> e-chain® link

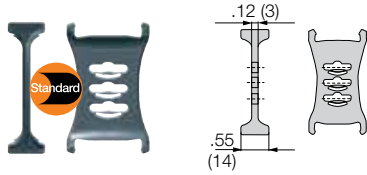

Separator, wide base

Unassembled	Part No. 42-1
Assembled	Part No. 42-1-1

- **Standard separator 42-1 for all applications**

Separator with wide base for maximum locking strength and safe standing in e-chains®.

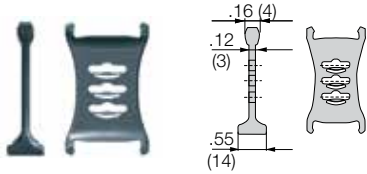

Separator, narrow head

Unassembled	Part No. 42-2
Assembled	Part No. 42-2-1

- **Separator 42-2 For even faster installation**

is used when vertical and horizontal separation is required. Due to its slot, it allows basic vertical/horizontal shelving arrangements.

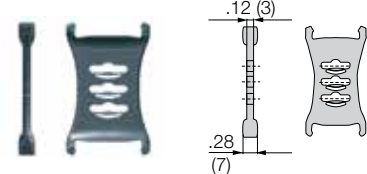

Separator, narrow base

Unassembled	Part No. 42-3
Assembled	Part No. 42-3-1

- **Separator 42-3 For many thin cables**

is used when vertical and horizontal separation is required. Due to its slot, it allows basic vertical/horizontal shelving arrangements.

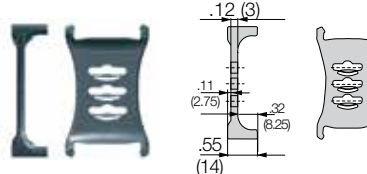

Separator, asymmetrical

Unassembled	Part No. 42-4
Assembled	Part No. 42-4-1

- **Separator 42-4 For side mounted applications**

is used when vertical and horizontal separation is required. Due to its slot, it allows basic vertical/horizontal shelving arrangements.

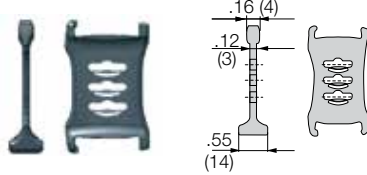

Separator, asymmetrical

Unassembled	Part No. 42-5
Assembled	Part No. 42-5-1

- **Separator 42-5 Locks safely in .30" (7.5 mm) increments**

Notch separator for exact positioning in e-chains®. Recommended for side-mounted applications.

**Lockable full-width shelves - for the standard interior separation**

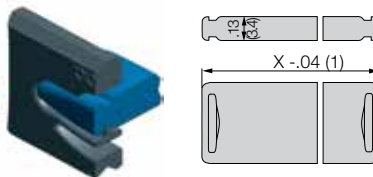

Full width shelf, lockable

Unassembled	Part No. 3200-X
Assembled	Part No. 3210-X

- **Full width shelf, lockable**

Shelf locks safely into separators on both ends, fixed width possible. Separators can be moved freely over the shelf in horizontal direction. Can be used at one height.

Width X in. (mm)	Part No. Unassembled	Part No. Assembled	Width X in. (mm)	Part No. Unassembled	Part No. Assembled	Width X in. (mm)	Part No. Unassembled	Part No. Assembled
1.97 (050)	3200-50	3210-50	4.92 (125)	3200-125	3210-125	8.86 (225)	3200-225	3210-225
2.95 (075)	3200-75	3210-75	5.91 (150)	3200-150	3210-150	9.84 (250)	3200-250	3210-250
3.94 (100)	3200-100	3210-100	6.89 (175)	3200-175	3210-175			
4.53 (115)	3200-115	3210-115	7.87 (200)	3200-200	3210-200			

e-chain system® E4-1  
 Series E4-42/H4-42/R4-42  
 Interior Separation - Previous Generation



E4-42  
 H4-42  
 R4-42

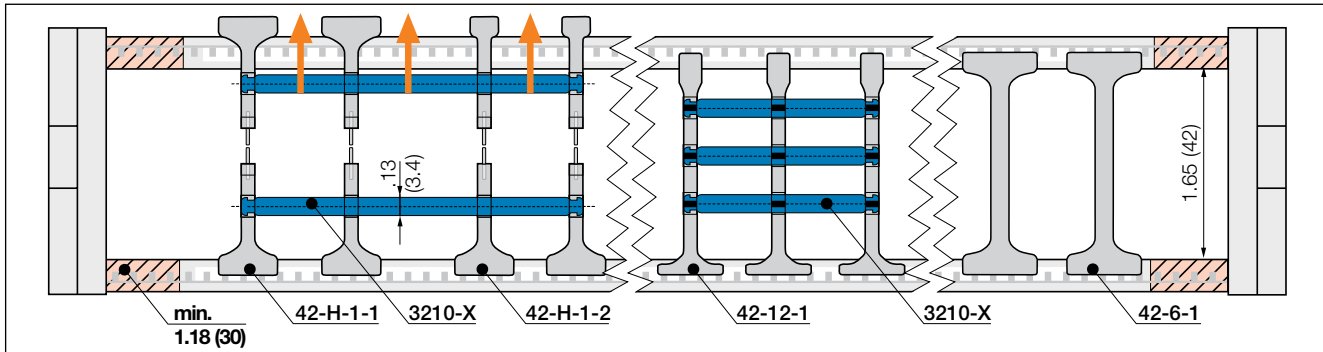

Note e-tube: Please maintain a lateral spacing of 1.18" (30 mm) between the separators and the side links. In the standard configuration separators are assembled every 2<sup>nd</sup> e-chain® link

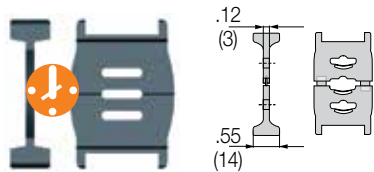

**Separator, wide base**

Unassembled Part No. 42-H-1  
 Assembled Part No. 42-H-1-1

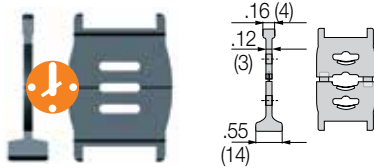

**Separator, narrow head**

Unassembled Part No. 42-H-2  
 Assembled Part No. 42-H-2-1

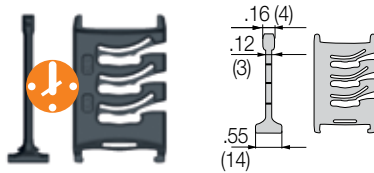

**Lean separator**

Unassembled Part No. 42-12  
 Assembled Part No. 42-12-1



● **Split separators for all applications**

In order to fill e-chains® more easily and effectively, these separators can be split in the middle. This allows easier access to middle shelf partitions. Fast assembly and easy retrofit. 2 types available: with wide or narrow top.

● **Lean separators 42-12**

New design allows extremely fast fitting of shelves in several layers, which significantly reduces assembly time. Enables extremely fast replacement of individual cables in a very full e-chain®.

● **Lean separator design - several layers of cables fitted quickly, save up to 50%\* assembly time**

(\*Lean separator vs. standard separator - measured on a 4m long e-chain® fitted with 12 cables in the igus® harnessing factory)

**More interior separation options**

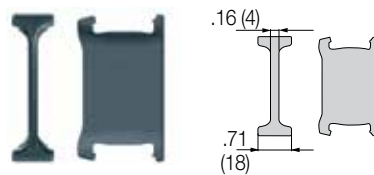

**Notch locking separator**

Unassembled Part No. 42-6  
 Assembled Part No. 42-6-1

● **Notch locking separator for increased holding force**

Notch locking separators offer higher crossbar opening forces for high humidity and/or large hydraulic hoses. They can be positioned precisely and then locked in position

PDF: [igus.com/e-chain-pdfs](http://igus.com/e-chain-pdfs)  
 Product information: [igus.com/e-chains](http://igus.com/e-chains)



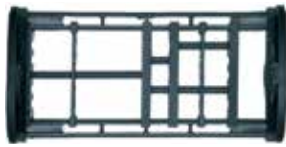

### Shelves and Separators

e-chains® and e-tubes can be subdivided both vertically and horizontally using the various interior separation elements. ► **Design, Chapter 1** for layout recommendations.

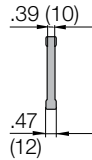
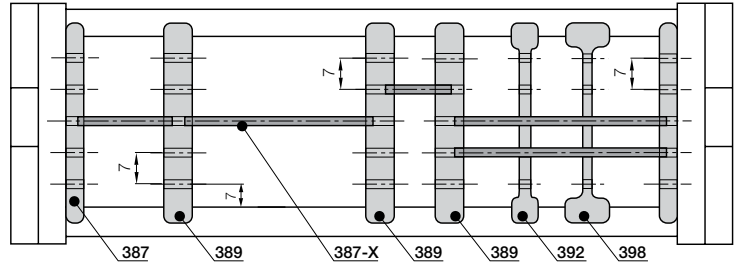

#### Split separator (chain only)

Unassembled	<b>Part No. T423</b>
Assembled	<b>Part No. T423M</b>

- **Split separator T423 for e-chains®**  
This separator is ideal for subsequent shelving or the initial assembly of the e-chain. Fast assembly and disassembly using a hinge/push mechanism. Enhances flexibility

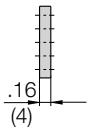

#### Side Plate

Unassembled	<b>Part No. 386</b>
Assembled	<b>Part No. 387</b>

- **Side plates 386**  
This component is used to form the basic pattern of a shelf system.

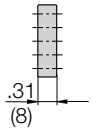

#### Vertical Separator

Unassembled	<b>Part No. 388</b>
Assembled	<b>Part No. 389</b>

- **Vertical separator 388**  
This component is used to form the basic pattern of a shelf system.

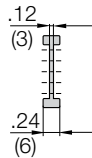

#### Slotted Separators

Unassembled	<b>Part No. 391</b>
Assembled	<b>Part No. 392</b>

- **Closed Slotted separators 391**  
These are used for complex subdivisions. However, they cannot be retrofitted into an existing interior separation system without removing the shelves first.

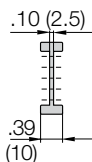

#### Slotted Separators, Open

Unassembled	<b>Part No. 397</b>
Assembled	<b>Part No. 398</b>

- **Open slotted separator 397**  
This separator can be retrofitted into an existing interior separation system without removing the shelves, as long as these shelves fit into the middle 3 slots only.

Width X	Usable Width	Part No.	Part No.
in. (mm)	in. (mm)	Unassembled	Assembled
.71 (18)	.39 (10)	<b>386-18</b>	<b>387-18</b>
.91 (23)	.59 (15)	<b>386-23</b>	<b>387-23</b>
.98 (25)	.67 (17)	<b>386-25</b>	<b>387-25</b>
1.10 (28)	.79 (20)	<b>386-28</b>	<b>387-28</b>
1.30 (33)	.98 (25)	<b>386-33</b>	<b>387-33</b>
1.69 (43)	1.38 (35)	<b>386-43</b>	<b>387-43</b>
1.97 (50)	1.65 (42)	<b>386-50</b>	<b>387-50</b>
2.13 (54)	1.81 (46)	<b>386-54</b>	<b>387-54</b>
2.44 (62)	2.13 (54)	<b>386-62</b>	<b>387-62</b>
2.95 (75)	2.64 (67)	<b>386-75</b>	<b>387-75</b>
3.43 (87)	3.12 (87)	<b>386-87</b>	<b>387-87</b>
3.94 (100)	3.62 (92)	<b>386-100</b>	<b>387-100</b>
4.25 (108)	3.94 (100)	<b>386-108</b>	<b>387-108</b>
4.92 (125)	4.61 (117)	<b>386-125</b>	<b>387-125</b>
5.91 (150)	5.59 (142)	<b>386-150</b>	<b>387-150</b>
6.89 (175)	6.57 (167)	<b>386-175</b>	<b>387-175</b>
7.87 (200)	7.56 (192)	<b>386-200</b>	<b>387-200</b>
8.19 (208)	7.87 (200)	<b>386-208</b>	<b>387-208</b>

#### Shelves 386-XX

These components form the basic pattern of a shelf system. Shelves of various widths can be arranged at 5 different heights in .28" (7mm) increments

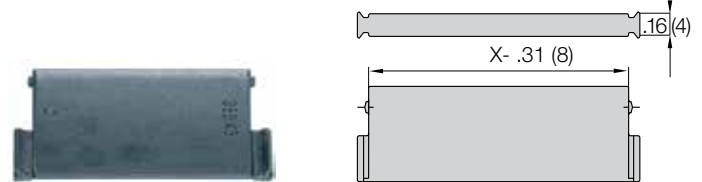

The diagram below is for reference purposes only. Multiple configurations are possible. To create your e-chain shelving cross section please see our online e-chain configurator. Call 1-800-521-2747 for assistance and/or go to [igus.com](http://igus.com) click on the **Products** drop down menu, choose **e-chain Cable Carriers** and on the next drop down menu simply click on **e-chain Configurator**.

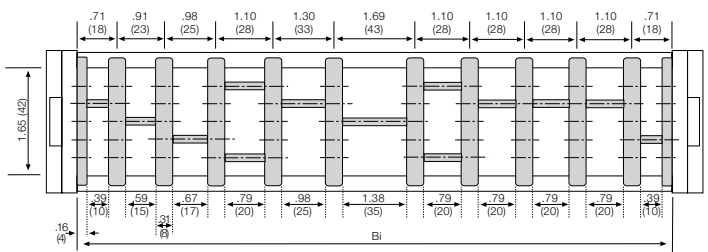

e-chain system® E4-1  
 Series E4-42/H4-42/R4-42  
 Interior Separation - Previous Generation



E4-42  
 H4-42  
 R4-42

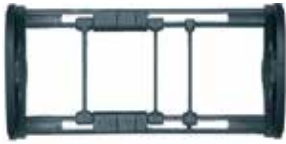

**Vertical separators and spacers**

Vertical separators are used if a vertical subdivision of the e-chain® interior is required. By standard, vertical separators are assembled every other e-chain® link.

**NOTE:** Observe a lateral spacing of at least .98 in. (25mm) for e-tubes

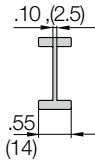
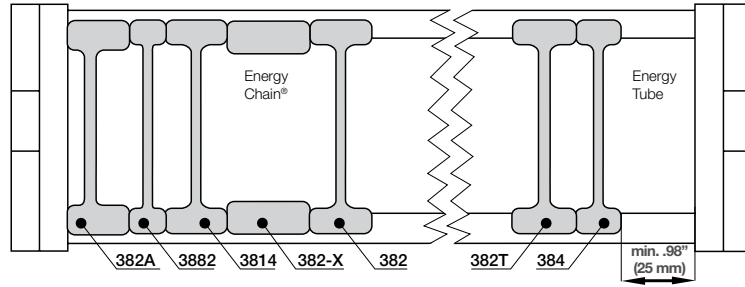

**Separator (chain/tube)**

Unassembled **Part No. 380**  
 Assembled **Part No. 381**

- **Standard separator 380 for e-chains® and e-tubes**  
 This separator offers safe stability due to its wide base design, also when used with thick cables or hoses.

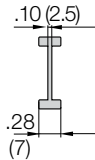

**Separator (chain only)**

Unassembled **Part No. 3881**  
 Assembled **Part No. 3882**

- **Vertical separator 3881 for e-chains®**  
 This separator features a narrow 7mm base for applications where a large number of small cables need to be individually separated.

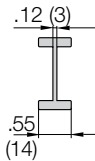

**Vertical Separator (tubes only)**

**Part No. 380T Part No. 381T**

- **Locking separator 380T for e-tubes**  
 It clamps to the fixed radius and remains free along the other radius to facilitate lid removal. When installing please ensure they are identically aligned.

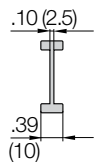

**Separator (chain only)**

Unassembled **Part No. 383**  
 Assembled **Part No. 384**

- **Vertical separator 383 for e-chains®**  
 This separator features an increased retention force for applications exposed to very high humidity or extreme loads. It features asymmetric claws for the crossbar which results in the increased retention force.

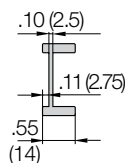

**Asymmetric separator (chain only)**

Unassembled **Part No. 381A**  
 Assembled **Part No. 382A**

- **Asymmetrical separator 381A for e-chains®**  
 This separator features an (14mm) base. It can be used in combinations between spacers of different widths and vertical separators in side mounted applications.



**Spacer (chain only)**

Unassembled **Part No. 381-XX**  
 Assembled **Part No. 382-XX**  
 XX = width of the spacer

- **NOTE ON SPACERS**  
 Vertical separators are adjustable, but can be fixed in position by means of a spacer. Spacers are most often necessary for side mounted applications. The available inner height is reduced by .08" (2mm) **per spacer** (for example if one spacer is placed on either side of the separator, the overall inner height is reduced by .16" (4mm)). To avoid this, place the spacers on the **outside** of the opening crossbar (**not for long travels**).

Spacers available in the following sizes:

Part No. Unassembled	Part No. Assembled	in.	(mm)
381 -10	382 -10	.39"	(10)
381 -15	382 -15	.59"	(15)
381 -20	382 -20	.79"	(20)

PDF: [igus.com/e-chain-pdfs](http://igus.com/e-chain-pdfs)  
 Product information: [igus.com/e-chains](http://igus.com/e-chains)





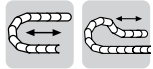

Standard

**Option 1: pivoting**

- Recommended for unsupported and gliding applications
- Attachment capability on all sides
- Bolted connection outside of chain cross-section
- Space restricted conditions
- Corrosion resistant

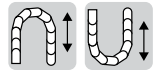

**Option 2: locking**

- Profile rail option
- Universal use
- Corrosion resistant
- Vertical hanging/standing travels
- Extreme accelerations

**Part Number Structure**

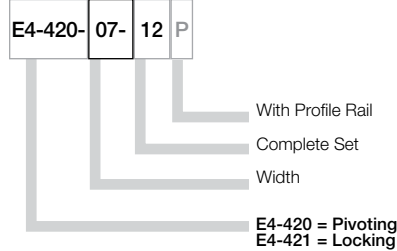

Due to the design of the E4-42 series chains, please note the following when ordering brackets:

Even number of links = full set, part number ending in -12; Odd number of links = 2 pieces, part number ending in -1

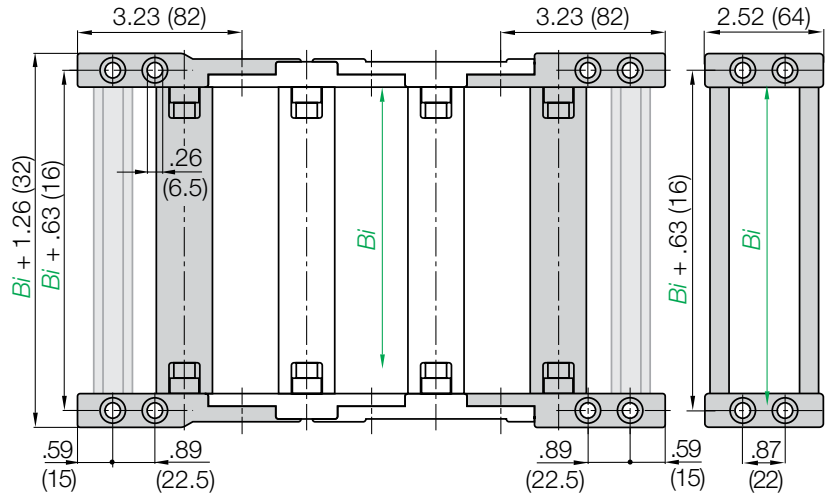
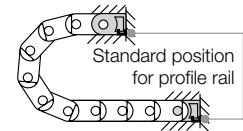
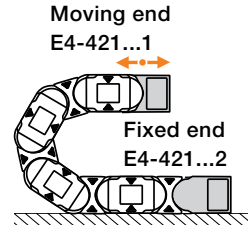
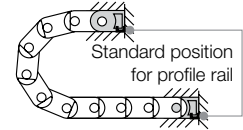
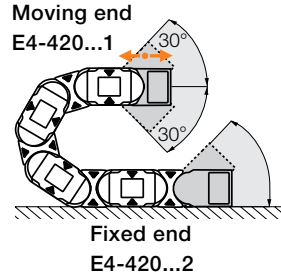

Part No. Full Set (pivoting)  
Series E4-42 or H4-42  
E4-420-Width-12

Part No. Full Set (pivoting)  
with profile rail  
Series E4-42 or H4-42  
E4-420-Width-12P

Part number examples are shown for pivoting brackets for e-chain.  
For locking brackets change part number to 421

Width	Part No. Full Set chain		With Profile Rail	Bi in. (mm)	Width	Part No. Full Set chain		With Profile Rail	Bi in. (mm)
	Pivoting	Locking				Pivoting	Locking		
-05*	E4-420	E4-421	-05-12	1.97 (50)	-212	E4-420	E4-421	-212-12	8.35 (212)
-06	E4-420	E4-421	-06-12	2.68 (68)	-23	E4-420	E4-421	-23-12	8.86 (225)
-07	E4-420	E4-421	-07-12	2.95 (75)	-237	E4-420	E4-421	-237-12	9.33 (237)
-087	E4-420	E4-421	-087-12	3.43 (87)	-25	E4-420	E4-421	-25-12	9.84 (250)
-097	E4-420	E4-421	-097-12	3.82 (97)	-262	E4-420	E4-421	-262-12	10.31 (262)
-10	E4-420	E4-421	-10-12	3.94 (100)	-28	E4-420	E4-421	-28-12	10.83 (275)
-11	E4-420	E4-421	-11-12	4.25 (108)	-29	E4-420	E4-421	-29-12	11.30 (287)
-112	E4-420	E4-421	-112-12	4.41 (112)	-30	E4-420	E4-421	-30-12	11.81 (300)
-12	E4-420	E4-421	-12-12	4.92 (125)	-312	E4-420	E4-421	-312-12	12.28 (312)
-137	E4-420	E4-421	-137-12	5.39 (137)	-325	E4-420	E4-421	-325-12	12.79 (325)
-15	E4-420	E4-421	-15-12	5.91 (150)	-337	E4-420	E4-421	-337-12	13.27 (337)
-162	E4-420	E4-421	-162-12	6.38 (162)	-350	E4-420	E4-421	-350-12	13.78 (350)
-17	E4-420	E4-421	-17-12	6.61 (168)	-362	E4-420	E4-421	-362-12	14.25 (362)
-18	E4-420	E4-421	-18-12	6.89 (175)	-375	E4-420	E4-421	-375-12	14.76 (375)
-187	E4-420	E4-421	-187-12	7.36 (187)	-387	E4-420	E4-421	-387-12	15.24 (387)
-20	E4-420	E4-421	-20-12	7.87 (200)	-400	E4-420	E4-421	-400-12	15.75 (400)

# e-chain system® E4-1

## Series E4-42/H4-42/R4-42

### Mounting Brackets



E4-42  
H4-42  
R4-42

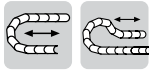

**Standard**

#### Option 1: pivoting

- Recommended for unsupported and gliding applications
- Attachment capability on all sides
- Bolted connection outside of chain cross-section
- Space restricted conditions
- Corrosion resistant

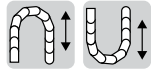

#### Option 2: locking

- Profile rail option
- Universal use
- Corrosion resistant
- Vertical hanging/standing travels
- Extreme accelerations

#### Part Number Structure

R4-420-07-12 P

With Profile Rail

Complete Set

Width

R4-420 = Pivoting  
R4-421 = Locking

Due to the design of the R4-42 series chains, please note the following when ordering brackets:

Even number of links = full set, part number ending in -12; Odd number of links = 2 pieces, part number ending in -1

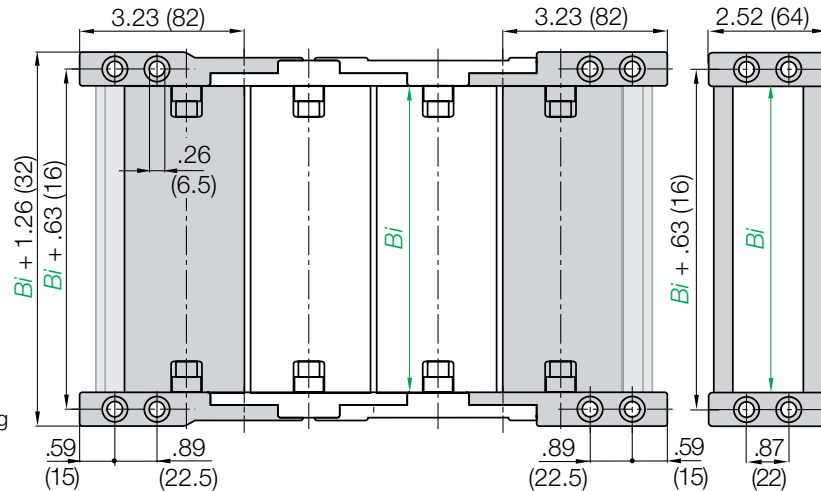
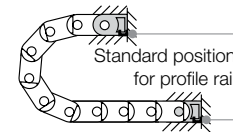
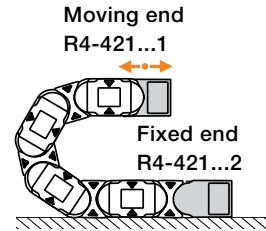
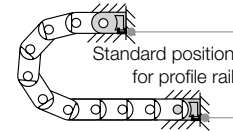
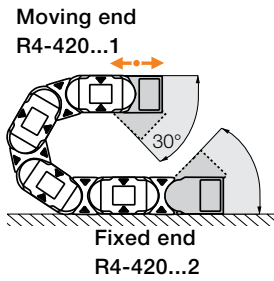

Part No. Full Set (pivoting)  
Tube Series R4-42  
R4-420-Width-12

Part No. Full Set (pivoting)  
with Profile Rail  
Tube Series R4-42  
R4-420-Width-12P

Part number examples are shown for pivoting brackets for e-chain.  
For locking brackets change part number to 421

Width	Part No. Full Set chain		With Profile Rail	$Bi$ in. (mm)
	Pivoting	Locking		
-05*	R4-420	R4-421	-05-12 P	1.97 (50)
-07	R4-420	R4-421	-07-12 P	2.95 (75)
-087	R4-420	R4-421	-087-12 P	3.43 (87)
-10	R4-420	R4-421	-10-12 P	3.94 (100)
-11	R4-420	R4-421	-11-12 P	4.25 (108)
-12	R4-420	R4-421	-12-12 P	4.92 (125)

Width	Part No. Full Set chain		With Profile Rail	$Bi$ in. (mm)
	Pivoting	Locking		
-15	R4-420	R4-421	-15-12 P	5.91 (150)
-17	R4-420	R4-421	-17-12 P	6.61 (168)
-20	R4-420	R4-421	-20-12 P	7.87 (200)
-25	R4-420	R4-421	-25-12 P	9.84 (250)
-30	R4-420	ER4-421	-30-12 P	11.81 (300)

PDF: [igus.com/e-chain-pdfs](http://igus.com/e-chain-pdfs)  
Product information: [igus.com/e-chains](http://igus.com/e-chains)



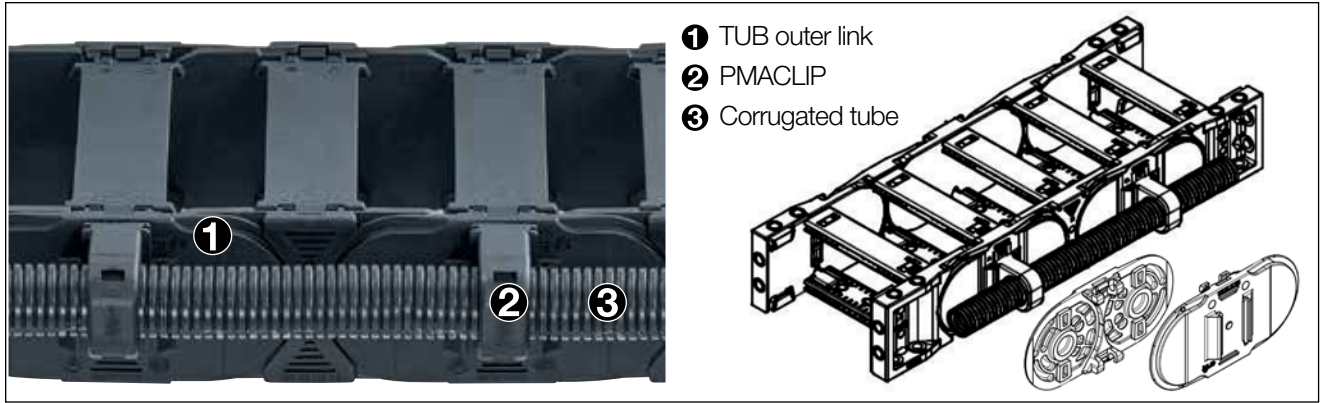

- ❶ TUB outer link
- ❷ PMACLIP
- ❸ Corrugated tube

### TUB | Safe guidance for corrugated tubes parallel to the e-chain®

- Additional, simple guidance for corrugated tubes on the outside of the e-chain®
- PMACLIP allows corrugated tubes with nominal widths .28 (07mm), .39 (10mm), .47 (12mm), .67 (17mm) to be easily clipped on
- Easy access to the corrugated tubes, fast replacement of the hoses
- Reduce assembly time and cost - easy to assemble, without any additional screws or tools
- The part number includes the e-chain® with TUB side sections; the PMACLIP support and the hose are ordered separately

Part No. TUB	Part No. TUB	Part No. TUB	For corrugated tube nominal diameter
Outer link right*	Outer link left*	Outer link at both ends*	Ø [mm]
E4-42-XXXTUBR-R-0	E4-42-XXXTUBL-R-0	E4-42-XXXTUB-R-0	.28 (07), .39 (10), .47 (12), .67 (17)

\*View from the fixed end

Part number appended with width index **XXX Bi** and radius (**R**) e.g.

E4-42-100TUBR-150-0 = with TUB outer sections every 2<sup>nd</sup> right hand link



### Extension links - for extremely wide e-chains® up to 9.84 ft (3m)

- For applications in which particularly high fill weights necessitate extremely wide e-chains®
- The extension link design allows virtually limitless side-by-side attachment of chains
- The unsupported length of a chain can be increased when additional loads are required
- Extension links can be used with e-chains®, e-tubes or a combination of both
- They are suitable for unsupported and gliding applications in a guide trough
- e-chains® with extension links are attached with KMA or steel mounting brackets.

Part number example for e-chain®

E4-42-10/20/10-200-0  
E4-42-Bi1/Bi2/Bi3-R-0

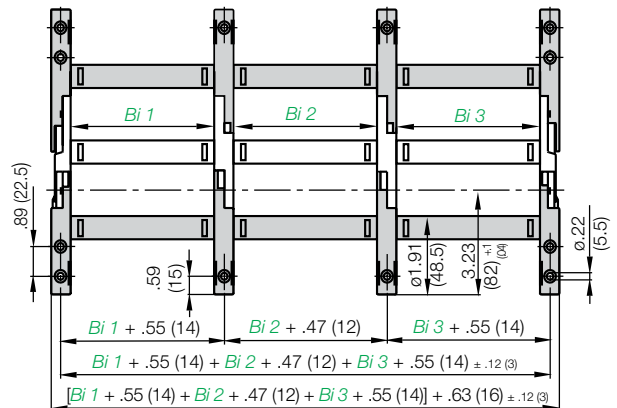

We **strongly recommend** on-site consultation with an igus® technician for individual advice regarding mounting brackets, guide troughs and other design details.

Part No.	Part No.	Part No.
Extension link e-chain®	Extension link e-tube	Extension link as an individual part
E4-42-Bi1/Bi2/Bi3-R-0	R4-42-Bi1/Bi2/Bi3-R-0	384-R-

Complete Part No. with the width index **Bi1/Bi2/Bi3/etc.** and the radius (**R**). Example: E4-32-10/20/10-200-0

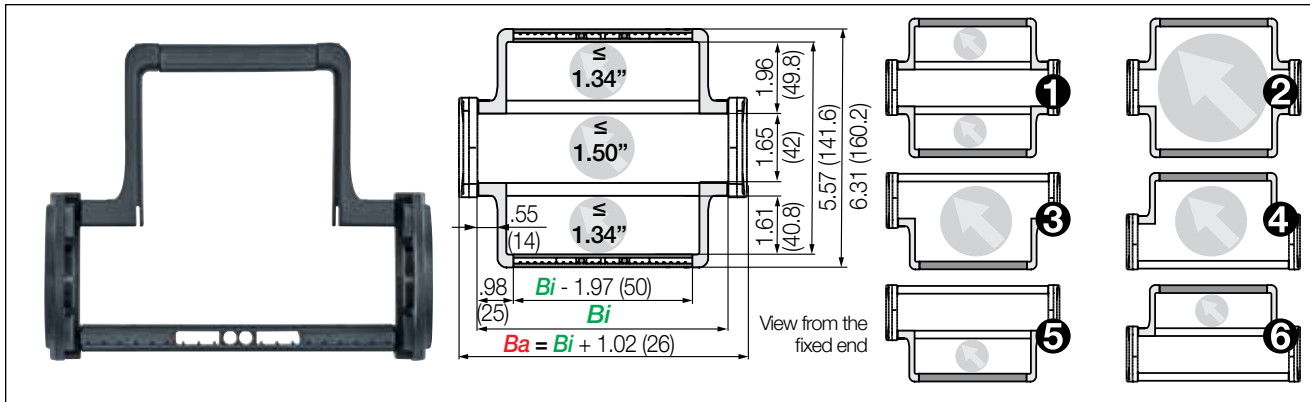

### Extender crossbars with flexible width | Safe guiding for large hoses

- For guiding and protecting large hoses
- With mounting for noise dampers
- Cable-friendly design, high crossbar holding force
- The openable extender crossbars can be fitted in different ways and combinations
- Optionally openable along the inner or outer radius

#### Versions e-chain<sup>®</sup>

##### with extender crossbar

	Hose Ø ≤ in. (mm)	Part No. e-chain <sup>®</sup> with extender crossbar
❶ Extender crossbar and standard crossbar alternating along the inner and outer radius <sup>1)</sup>	1.34 (34)	E4-42-XXXHB50-R-0
❷ Extender crossbar on both sides along the inner and outer radius <sup>2)</sup>	5.12 (130)	E4-42-XXXB50-R-0
❸ Extender crossbar along the outer radius <sup>3)</sup>	3.35 (85)	E4-42-XXXBE50-R-0
❹ Extender crossbar along the inner radius <sup>2)</sup>	3.35 (85)	E4-42-XXXBZ50-R-0
❺ Extender crossbar and standard crossbar alternating along the outer radius <sup>3)</sup>	1.34 (34)	E4-42-XXXHBE50-R-0
❻ Extender crossbar and standard crossbar alternating along inner radius <sup>1)</sup>	1.34 (34)	E4-42-XXXHBZ50-R-0

1) Minimum bend radius: **R 125**

2) Minimum bend radius: **R 150**

3) Minimum bend radius: **R 075** \*Width available upon request. Delivery time upon request

#### Bi [mm] Available inner widths

| 100 | 125 | 137 | 150 | 162 | 175 | 187 | 200 | 212 | 225 | 237 | 250 |  
| 262 | 275 | 287 | 300 | 312 | 325 | 337 | 350 | 362 | 375 | 387 | 400 |

Complete Part No. with the width index **XXX Bi** and the radius (**R**). Example

E4-42-100B50-150-0 = extender crossbar on both sides along inner and outer radius



The E4.1 can be fitted with openable extender crossbars, which increase the size of the interior of the e-chain<sup>®</sup>. Crossbars can be fitted in various ways: from one or both sides, alternating with standard crossbars and or any combination

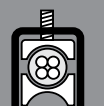



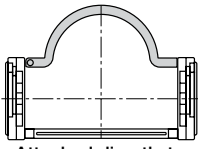

Attached directly to the side link.

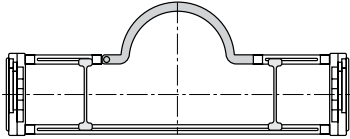

Round extender crossbar combined with standard snap-open crossbars.

### Extender crossbars

#### For careful guiding of large diameter cables and hoses

- Intended for cables and hoses with a maximum outer diameter of 4.13 in. (105 mm).
- Gliding operation with crossbars assembled along the outer radius in conjunction with a special guide trough
- Gliding operation not guaranteed with crossbars assembled along the inner radius
- The extender crossbar can either be attached to the side links directly or can be used in combination with two standard snap-open crossbars.



Part No.	Max Ø Hose in. (mm)	Style	Installation Side Link	Combined with Snap-Open Crossbars
385-15-RHD115	4.13 (105)	Round	No	Yes
385-18-RD115	4.13 (105)	Round	Yes	No

### Hinged crossbars

- Typically, e-chain® crossbars are completely removable. In cases where it is preferable that the opening crossbars remain on the e-chain®, a hinged design has been developed.
- Hinged crossbar: Part No. 385-02
- Snap-open crossbar (shortened): Bi-1.48" (37.5 mm) Part No. 385-03 (smallest inner width Bi = 3.44" (87.5 mm))

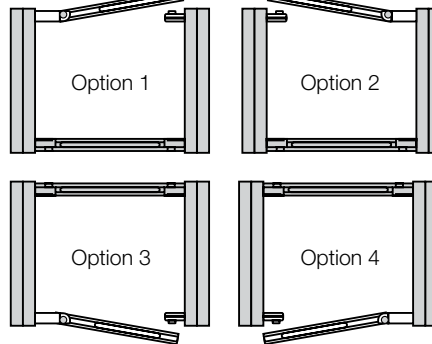
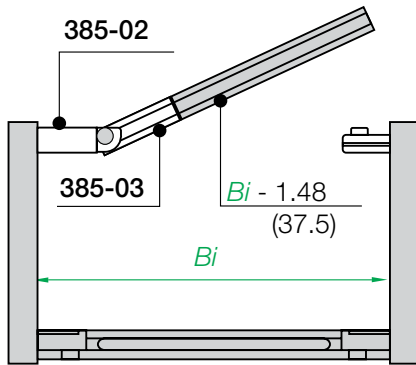

Part No.	Part No.	Part No. openable
e-chain® with hinged crossbar	swivel clip as an individual part	crossbar as an individual part
E4-42-Bi-Z-R-0	385-02	385-03

Chainfix clamps for the profile rail

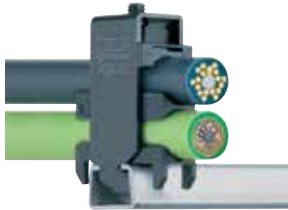

igus® Chainfix strain relief elements are available in either steel or stainless steel. They can be adjusted with a hexagon socket and are available in single, double and triple configurations.

Part No. Single Clamp		Part No. Double Clamp		Part No. Triple Clamp		Cable ø	
Steel	Stainless	Steel	Stainless	Steel	Stainless	in.	(mm)
CFX12-1	CFX12-1E	CFX12-2	CFX12-2E	CFX12-3	–	.24 - .47	(06 - 12)
CFX14-1	CFX14-1E	CFX14-2	CFX14-2E	CFX14-3	–	.47 - .55	(12 - 14)
CFX16-1	CFX16-1E	CFX16-2	CFX16-2E	CFX16-3	–	.55 - .63	(14 - 16)
CFX18-1	CFX18-1E	CFX18-2	CFX18-2E	CFX18-3	–	.63 - .71	(16 - 18)
CFX20-1	CFX20-1E	CFX20-2	CFX20-2E	CFX20-3	–	.71 - .79	(18 - 20)
CFX22-1	CFX22-1E	CFX22-2	CFX22-2E	CFX22-3	–	.79 - .87	(20 - 22)
CFX26-1	CFX26-1E	CFX26-2	CFX26-2E	–	–	.87 - 1.02	(22 - 26)
CFX30-1	CFX30-1E	CFX30-2	CFX30-2E	–	–	1.02 - 1.18	(26 - 30)
CFX34-1	CFX34-1E	CFX34-2	CFX34-2E	–	–	1.18 - 1.34	(30 - 34)
CFX38-1	CFX38-1E	–	–	–	–	1.34 - 1.50	(34 - 38)
CFX42-1	CFX42-1E	–	–	–	–	1.50 - 1.65	(38 - 42)

For more information please refer to strain relief section of Chapter 10.

Tiewrap Plates

Option 1:

Tiewrap plates as an individual part

Available as an individual component, can be fixed onto a mounting bracket with the use of a profile rail.

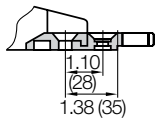

Shown assembled

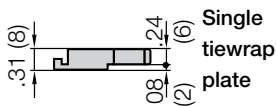

Single tiewrap plate

Tiewrap Plate	n Number of Teeth	C Overall Width in. (mm)	B Bore Width in. (mm)	Center Bore
3050-ZB	5	1.97 (50)	1.18 (30)	no
3075-ZB	7	2.95 (75)	2.16 (55)	no
3100-ZB	10	3.94 (100)	3.15 (80)	no
3115-ZB	11	4.53 (115)	3.74 (95)	no
3125-ZB	12	4.92 (125)	4.13 (105)	no
3150-ZB	15	5.91 (150)	5.12 (130)	no
3175-ZB	17	6.89 (175)	6.10 (155)	no
3200-ZB	20	7.87 (200)	7.09 (180)	yes
3225-ZB	22	8.86 (225)	8.07 (205)	yes
3250-ZB	25	9.84 (250)	9.06 (230)	yes

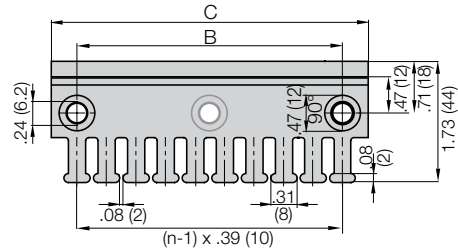

If used with KMA brackets with profile rail please add "KMA" to the end of the part number.

Example: 3050-ZBKMA

For more information please refer to strain relief section of Chapter 10

Option 2:

Clip-on Tiewrap plates

Available as a clip-on tiewrap plate without the use of bolts They are inserted and removed with a screwdriver used as a lever. Clip-on tiewrap plates are also available as an attachment to the opening crossbars.



Part No.	Number of Teeth	Width of Strain Relief in. (mm)
3050-ZC	5	1.97 (50)
3075-ZC	7	2.95 (75)

For more information please refer to strain relief section of Chapter 10.



Width of Crossbar  
E4-42-05-200-0

	$B_{Ri}$	Installation Part No.
-05	3.19 (81)	93-50-200
-06	3.90 (99)	93-50-225
-07	4.17 (106)	93-50-225
-087	4.69 (119)	93-50-250
-097	4.92 (125)	93-50-250
-10	5.16 (131)	93-50-250
-11	5.47 (139)	93-50-250
-112	5.67 (144)	93-50-275
-12	6.14 (156)	93-50-275
-137	6.65 (169)	93-50-300
-15	7.12 (181)	93-50-300
-162	7.64 (194)	93-50-325
-17	7.83 (199)	93-50-325
-18	8.11 (206)	93-50-325
-187	8.62 (219)	93-50-350
-20	9.09 (231)	93-50-350
-212	9.61 (244)	93-50-375
-23	10.08 (256)	93-50-375
-237	10.59 (269)	93-50-400
-25	11.06 (281)	93-50-400
-262	11.57 (294)	93-50-425
-28	12.05 (306)	93-50-425
-29	12.56 (319)	93-50-450
-30	13.03 (331)	93-50-450
-312	13.54 (344)	93-50-475
-325	14.01 (356)	93-50-475
-337	14.52 (369)	93-50-500
-350	15.00 (381)	93-50-500
-362	15.51 (394)	93-50-525
-375	16.02 (407)	93-50-525
-387	16.50 (419)	93-50-550
-400	16.97 (431)	93-50-550

Guide troughs are used with applications where the upper run of the e-chain® glides on the lower run. If using igus® steel guide troughs, the following components are required:

- Full travel length of guide trough  
**Part No. 93-30**
- 1/2 travel length of glide bars  
**Part No. 93-01**
- Installation sets as end connectors  
**Part No. 93-50-XX**

-XX indicates the length of the profile rail on which the guide trough is mounted. The values and part numbers are specified in the table below. The standard length of the trough components and glide bars is 6.56 ft (2 m). The required overall length of the guide trough directly correlates to the length of travel

**Example:**

Length of travel 164 ft (50 m)  
Center mounted

**Required guide troughs:**

164 ft (50 m) guide trough,  
82 ft (25 m) glide bar  
= 25 sections of 6.56 ft (2 m) guide trough

**Part No. 93-30**

= 13 sections of 6.56 ft (2 m) glide bar

**Part No. 93-01**

Required number of installation sets:

= Number of guide trough components + 1  
= 25 + 1 = 26

Part No. of the installation sets **93-50-XXX**

Example: 93-50-400 for 15.75 (400 mm) long profile rail



Left: Guide trough with glide bars  
Right: Guide troughs without glide bars



Installation sets as section connectors

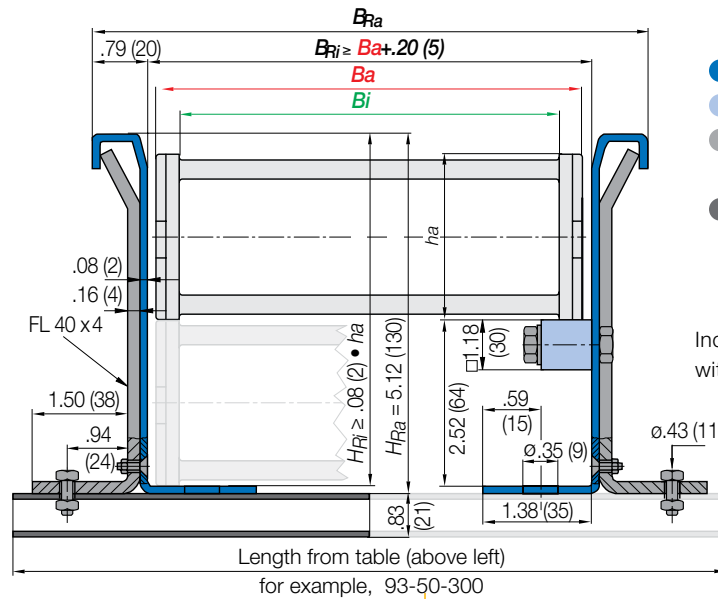

- Guide trough
- Glide bars
- Installation set "Basic"
- Profile rail

Individual attachment without profile rail

\* Specialized guide trough available upon request

Standard length profile rail