

Peak Emission Wavelength: 1460nm

The MTSM6414SMR2 is a 1460nm SWIR Emitter in a Seam Welded Surface Mount package for applications requiring high output power and efficiency.

FEATURES

- > 5mm x 5mm Seam Welded Surface Mount Package
- > High Reliability
- > High Output Power
- > Hermetically Sealed Package

APPLICATIONS

- > Bio Medical Applications
- > Optical Sensors
- > Aerospace
- > Industrial Controls

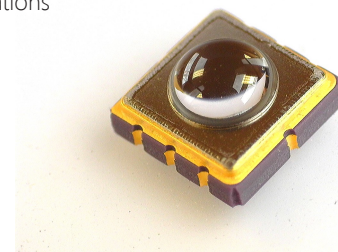

Absolute Maximum Ratings (Ta=25°C)



ITEMS	SYMBOL	RATINGS	UNIT
Forward Current (DC)	IF	100	mA
Forward Current (Pulse)*1	IFP	1	A
Reverse Voltage	VR	5	V
Power Dissipation	PD	100	mW
Operating Temperature Range	Topr	-20 ~ +85	°C
Storage Temperature Range	Tstg	-30 ~ +100	°C

Note: Also available on PCB - Starboard MTSM6414SMR2S (See Page 3)

*1: Tw=10μsec, T=10msec

Electrical & Optical Characteristics (Ta = 25°C)

ITEMS	SYMBOL	CONDITIONS	MIN	TYP	MAX	UNIT
Forward Voltage	VF	IF=50mA	--	0.88	--	V
Power Output	PO	IF=50mA	--	4.3	--	mW
Reverse Current	IR	VR=5V	--	--	10	μA
Peak Emission Wavelength	λp	IF=50mA	--	1460	--	nm
Spectral Line Half Width	Δλ	IF=50mA	--	78	--	nm
Half Intensity Beam Angle	Θ	IF=50mA	--	40	--	deg

Package Dimensions

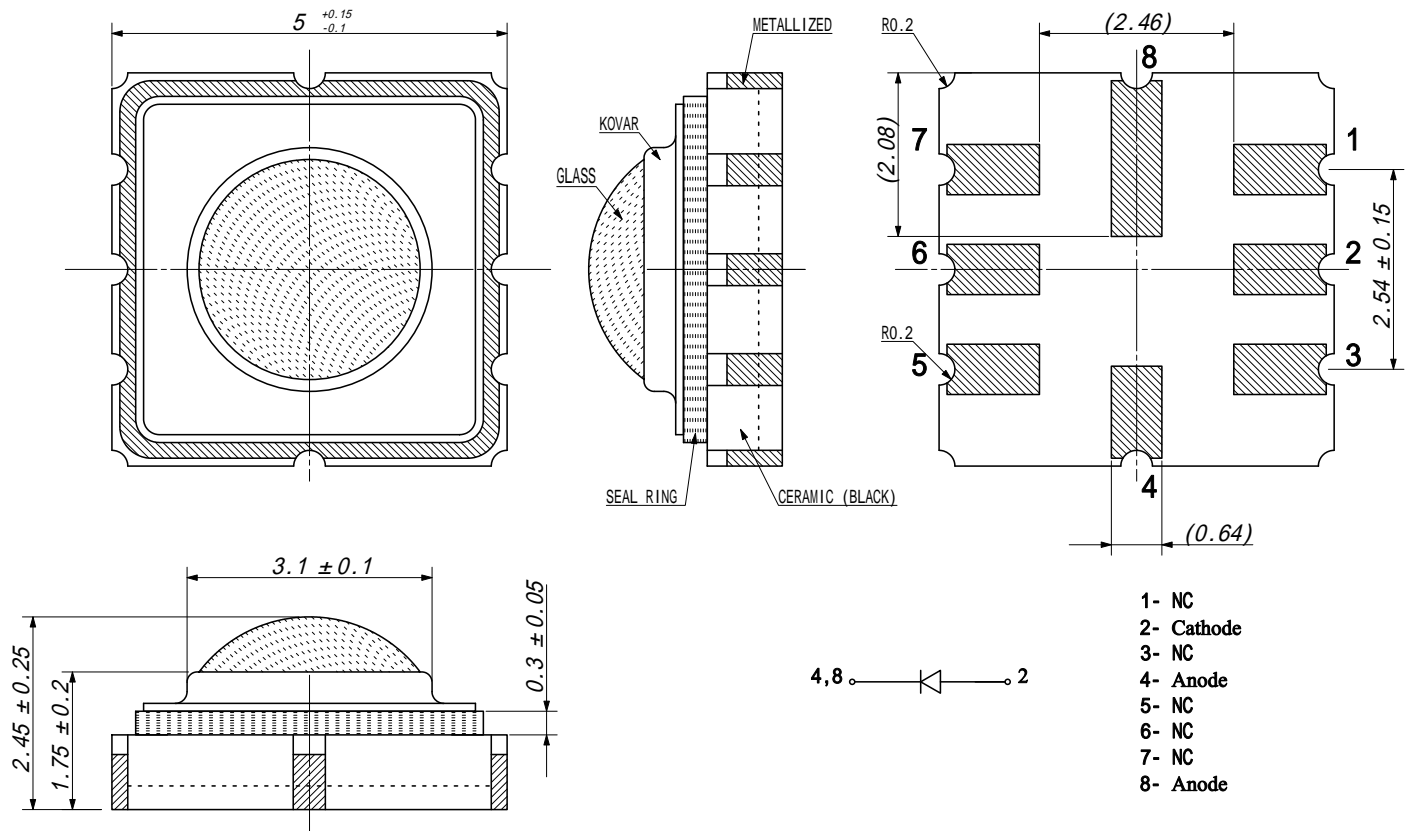

Recommended Soldering Pattern [mm]

Reflow Soldering Temperature-Profile [Pb free Soldering] (Recommend condition)

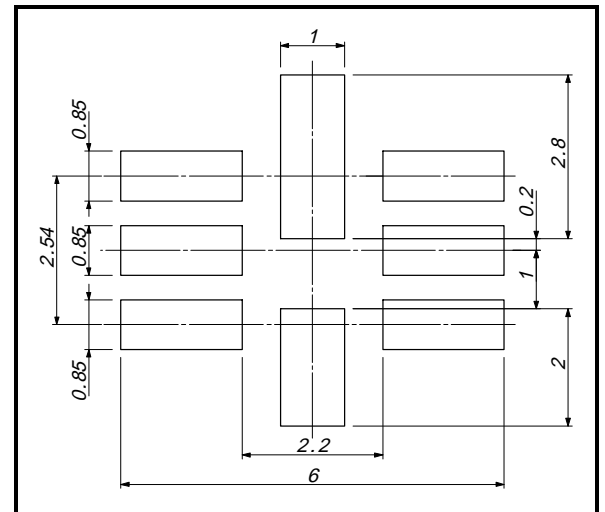
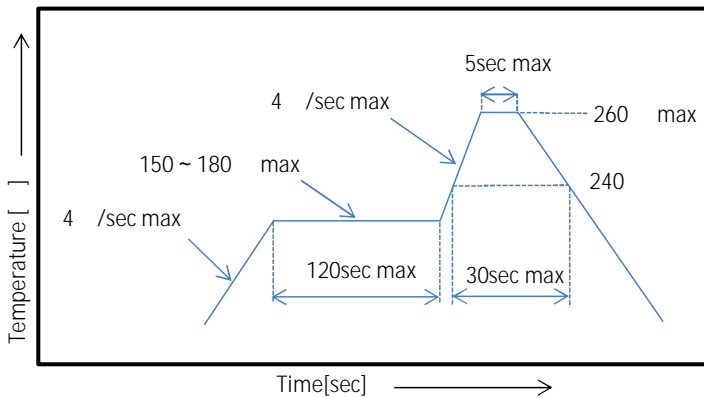

Starboard Dimensions

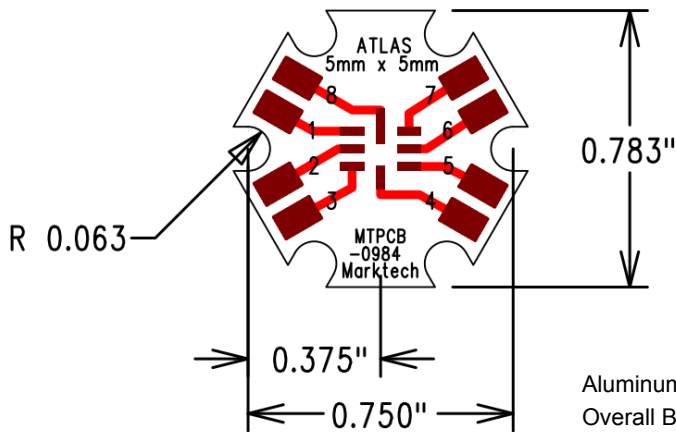

Pin 1	NC
Pin 2	Cathode
Pin 3	NC
Pin 4	Anode
Pin 5	NC
Pin 6	NC
Pin 7	NC
Pin 8	Anode

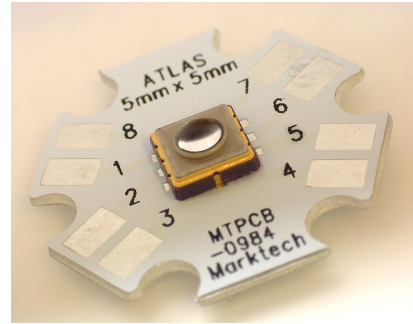

Aluminum Core Board 0.040" (1.02mm) Thickness
Overall Board Dimensions: +/- 0.010" (0.254mm)



We reserve the right to make changes to improve technical design and may do so without further notice. Parameters can vary in different applications. All operating parameters must be validated for each customer application by the customer.

The information contained herein is subject to change without notice.

2024-01-18

SPECTRAL RESPONSE

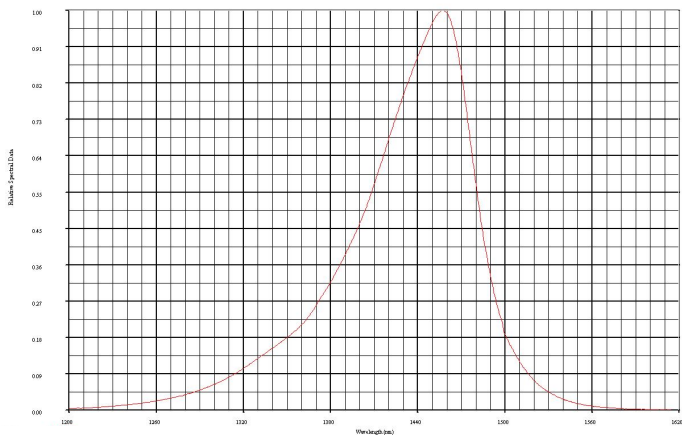

RADIATION DISTRIBUTION

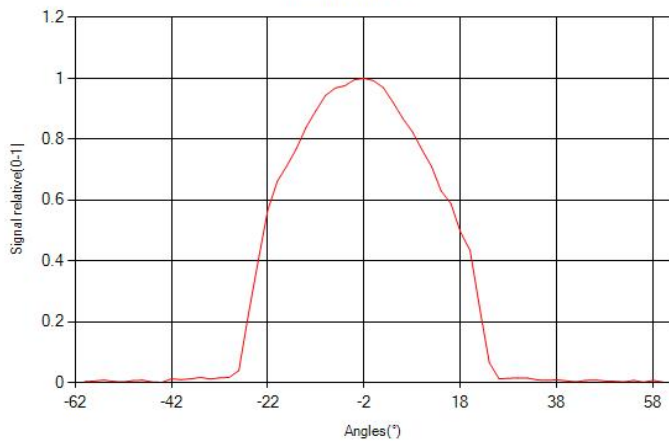

VIEW ANGLE

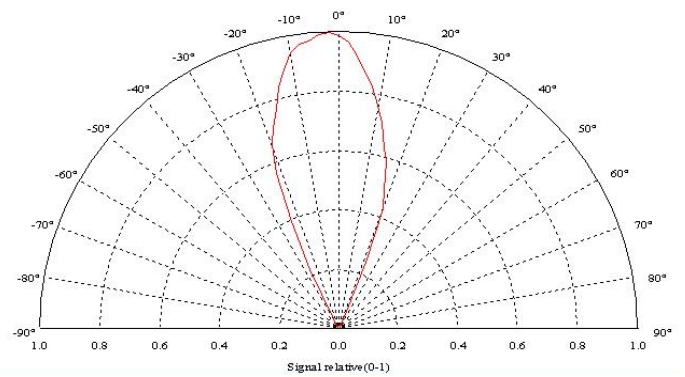

The information contained herein is subject to change without notice.

2024-01-18