

03

0317

Circular connectors with threaded joint M16 acc. to IEC 61076-2-106, IP40/IP68



Chassis plug acc. to IEC 61076-2-106, IP68, with threaded joint, for printed circuit boards, for back side mounting

03 0317

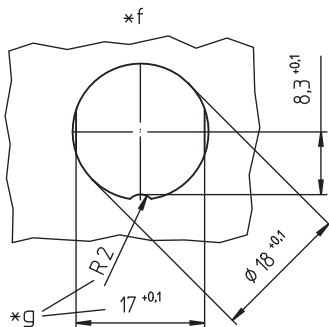
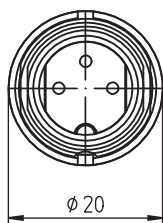
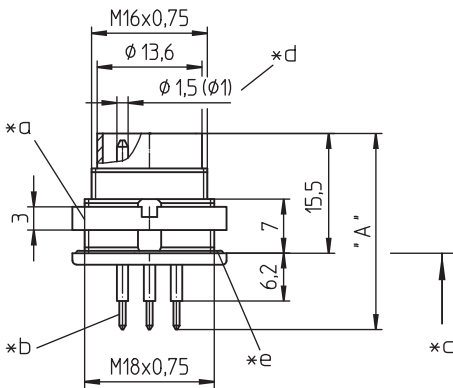
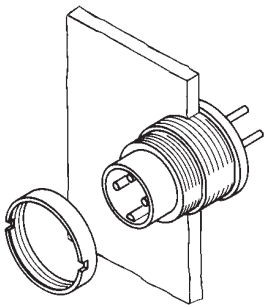

Environmental conditions

Temperature range -40 °C/+85 °C

Materials

Insulating body	PA GF, V-0 according to UL94
Contact pin	CuZn, silver-plated and flash gold-plated, tin-plated in solder area (3-8 poles) CuZn, pre-nickel and gold-plated, tin-plated in solder area (12-14 poles)
Housing	Zn diecast, pre-copper and nickel-plated
Ring screw	CuZn, nickel-plated
Seal	NBR

Mechanical data

Tightening torque connector	1-3 Nm
Tightening torque nut	1-3 Nm
Protection class	IP68 ¹

¹ according to IEC DIN EN 60529, only in locked condition with an appropriate counterpart; IPX8 requirements under agreement between manufacturer and user

Electrical data (at T_{amb} 20 °C)

Rated current	5 A (T _{amb} 40 °C, 3-8 poles) 3 A (T _{amb} 40 °C, 12-14 poles)
Rated voltage	with pollution degree 1: 300 V (versions 03, 04, 05-1, 06, 07) 100 V (versions 05, 07-1, 08, 08-1) 160 V (versions 12, 14) with pollution degree 2: 250 V (versions 03, 04) 32 V (versions 05, 07-1, 08, 08-1) 160 V (versions 05-1, 06, 07, 12, 14)
Rated impulse voltage	1500 V (versions 03, 04, 05-1, 06, 07, 12, 14) 500 V (versions 05, 07-1, 08, 08-1)
Material group	II (IEC)/1 (UL) (400 ≅ CTI < 600)
Overvoltage category	I
Insulation resistance	> 100 MΩ

Associated products

Counterparts			
☞ 0321	☞ 0322	☞ 0322-1	
☞ 032200	☞ 0360	☞ 036000	
Accessories			
☞ 0383	☞ 038399	☞ 0384	

03

0317

Pin configurations, solder side view

 0385

 038899

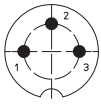

03-a
0317 03

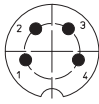

04-a
0317 04

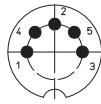

05-b
0317 05

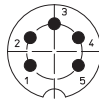

05-a
0317 05-1

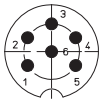

06-a
0317 06

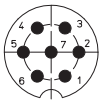

07-a
0317 07

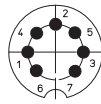

07-b
0317 07-1

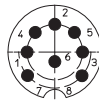

0317 08

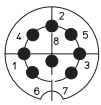

08-a
0317 08-1

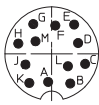

12-a
0317 12

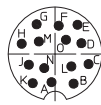

14-a
0317 14

03

0317

Printed circuit board layout, solder side view

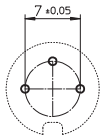

03-a
0317 03

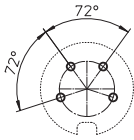

04-a
0317 04

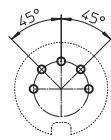

05-b
0317 05

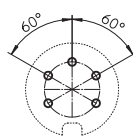

05-a
0317 05-1

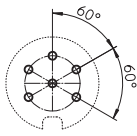

06-a
0317 06

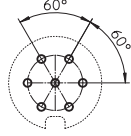

07-a
0317 07

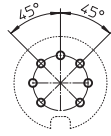

07-b
0317 07-1

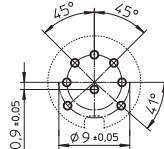

0317 08

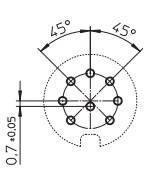

08-a
0317 08-1

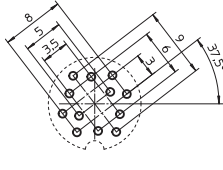

12-a
0317 12

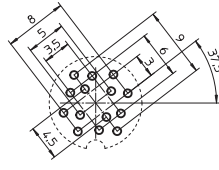

14-a
0317 14

- *a nut enclosed separately
- *b for bore hole of PCB
Ø 1,0 mm (0317 03–0317 08-1)
Ø 0,7 mm (0317 12–0317 14)
- *c mounting direction
- *d contact pin
Ø 1.5 mm (0317 03–0317 08-1)
Ø 1.0 mm (0317 12–0317 14)
- *e O-ring gasket
- *f port in mounting plate
- *g anti-rotation, alternative execution

03

0317

Designation	Pole Number	PU (Pieces)	MDQ (Pieces)	Dimensions A (mm)
0317 03	3	50	100	25.4
0317 04	4	50	100	25.4
0317 05	5	50	100	25.4
0317 05-1	5	50	100	25.4
0317 06	6	50	100	25.4
0317 07	7	50	100	25.4
0317 07-1	7	50	100	25.4
0317 08	8	50	100	25.4
0317 08-1	8	50	100	25.4
0317 12	12	50	100	24.8
0317 14	14	50	100	24.8

Packaging:
in a cardboard box