

9mm Magnetic Connector, 4mm Sheathed Jack, Right-Angle

CT4519



Features:

- IEC 61010-031 Safety rated
- Magnetic connector to 4 mm sheathed jack
- Reinforced insulation
- Higher category working voltage
- 9 mm Diameter magnetic connector
- CE Mark
- RoHS 2 Compliant

Description:

Cal Test's new CT4519 adaptor features a magnetic connector to a 4 mm jack. Primarily designed for application on circuit breakers, terminal blocks, and photovoltaic panels, this adaptor incorporates a magnetic tip that provides a quick hands-free connection to ferrous conductors. Made with reinforced insulation, its category rating ensures a safe connection in environments where circuit breakers and photovoltaic panels are commonly located. The CT4519 is a great choice when an easy, reliable, and safe connection is desired.

Available in different colors. See Order Information on page 2.

For additional product information, cross-references, or other test accessory information, visit www.caltestelectronics.com.

Specifications:

- Voltage Rating: 1500 VDC CAT III / 1000 V CAT IV
- Max Current: 4 A
- Insulation: Polypropylene (PP)
- Magnet: N35
- Contact: Brass, Nickel Plated
- Working Temperature: -20°C to +80°C

Outline Drawing: (not to scale)

Dimensions: mm [in]

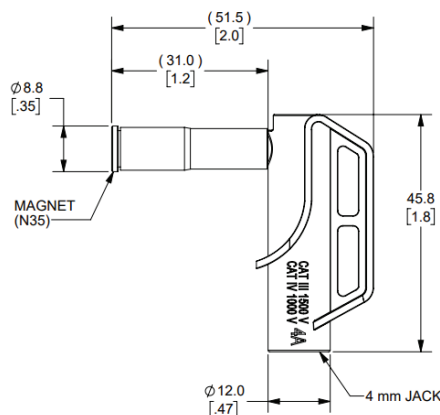

Specifications and appearance subject to change without notice
www.caltestelectronics.com

Ordering Information:

CT4519-#

Magnetic Connector, 4 mm Sheathed Jack, Right-Angle

#Colors Available:

-0 Black, -1 Brown, -2 Red, -5 Green, -6 Blue, -8 Grey

Order Example:

CT4519-2 (CT4519 Magnetic Conector, red)

Contact Info:

Phone: 714-221-9330

Fax: 714-921-9849

22820 Savi Ranch Pkwy.

Yorba Linda, CA 92887-4610 USA

www.caltelectronics.com

Copyright © Cal Test Electronics, Inc. All rights reserved. Information in this publication supersedes that in all previously published material. Trade names referenced are the service marks, trademarks or registered trademarks of their respective companies.