

MACX MCR-EX-SL-SD-21-40-LP - Solenoid driver



2865764

<https://www.phoenixcontact.com/us/products/2865764>

Please be informed that the data shown in this PDF document is generated from our online catalog. Please find the complete data in the user documentation. Our general terms of use for downloads are valid.



Ex i solenoid driver. For the intrinsically safe control of Ex i solenoid valves, alarm modules or LEDs installed in the Ex area. Current limitation at 40 mA. For gases up to Group IIC, loop-powered, electrical isolation, SIL 3. Screw connection.

Your advantages

- Mechanically compatible with the DIN rail connector
- Various output characteristic curves compatible with standard solenoid valves
- Loop-powered: the required power is supplied via the control signal on the input side.
- Up to SIL 3 in accordance with IEC 61508
- Installation in zone 2, protection type "n" (EN 60079-15) permitted
- Output: [Ex ia] IIC/[Ex ia] IIB
- 2-way electrical isolation
- Input: 19.2 V DC ... 30 V DC

Commercial data

Item number	2865764
Packing unit	1 pc
Minimum order quantity	1 pc
Sales key	C430
Product key	CK3142
Catalog page	Page 167 (C-5-2019)
GTIN	4046356325233
Weight per piece (including packing)	171.3 g
Weight per piece (excluding packing)	119 g
Customs tariff number	85437090
Country of origin	DE

Technical data

Product properties

Product type	Solenoid driver
Product family	MACX Analog
No. of channels	1
Type	Ex i signal conditioners with SIL functional safety
Compatible valve	<p>ASCO Coil 195</p> <p>Bürkert Coil AC 10 standard</p> <p>Bürkert Coil AC 10 high resistance</p> <p>Bürkert Coil AC 21 standard 700 mW / 65°C</p> <p>Bürkert Coil AC 21 high resistance 700 mW / 65°C</p> <p>Bürkert Coil AC 21 standard 900 mW / 45°C</p> <p>Bürkert Coil AC 21 high resistance 900 mW / 45°C</p> <p>Bürkert Coil AC 21 standard 900 mW / 60°C</p> <p>Bürkert Coil AC 21 high resistance 900 mW / 60°C</p> <p>Bürkert Coil G1 642735 standard 600 mW / 50°C</p> <p>Bürkert Coil G1 642735 high resistance 600 mW / 50°C</p> <p>Bürkert Coil G1 642735 standard 800 mW / 40°C</p> <p>Bürkert Coil G1 642735 high resistance 800 mW / 40°C</p> <p>Bürkert Coil G1 642735 standard 1000 mW / 40°C</p> <p>Bürkert Coil G1 642735 high resistance 1000 mW / 40°C</p> <p>Norgren Herion Coil 2050</p> <p>Norgren Herion Coil 2051</p> <p>Norgren Herion Coil 2052</p> <p>Norgren Herion Coil 2080 / 2082</p> <p>Norgren Herion Coil 2081 / 2083</p> <p>Norgren Herion Coil 2084</p> <p>Hörbiger Piezo P8 38x RF-Nx-SPN65 30 V type</p> <p>Hörbiger Piezo P20 381RF-NG-CPN61 30 V type</p> <p>Parker Coil VZ07 488650.01</p> <p>Parker Coil VZ33 494035.10</p> <p>Parker Coil VZ08 488660.01</p> <p>Parker Coil VZ09 488670.01</p> <p>Parker Coil VZ95 482160.01 EEx ia IIB T6</p> <p>Parker Coil VZ23 482870.01</p> <p>Samson Coil 3701-12 (12 V)</p> <p>Samson Coil 3701-13 (24 V)</p> <p>Samson Coil 3963-12 (12 V)</p> <p>Samson Coil 3963-13 (24 V)</p> <p>Samson Coil 3964-12 (12 V)</p> <p>Samson Coil 3964-13 (24 V)</p> <p>Seitz Pilot valve PV 12F73 Ci oH</p>

MACX MCR-EX-SL-SD-21-40-LP - Solenoid driver



2865764

<https://www.phoenixcontact.com/us/products/2865764>

	Seitz Pilot valve PV 12F73 Xi oH
	Seitz Pilot valve PV 12F73 Xi oH-2
Note	This is an extract of possible combinations of valves and solenoid drivers.

Electrical properties

Electrical isolation	2-way isolation
Maximum temperature coefficient	0.01 %/K

Electrical isolation

Test voltage	2.5 kV AC (50 Hz, 60 s)
Overvoltage category	II
Pollution degree	2

Electrical isolation Output/input IEC/EN 60079-11

Standards/regulations	IEC/EN 60079-11
Rated insulation voltage	375 V _{PP}

Electrical isolation Output/input IEC/EN 61010-1

Standards/regulations	IEC/EN 61010-1
Rated insulation voltage	300 V _{rms}
Insulation	Safe isolation

Supply

Supply voltage range	loop-powered, no external supply necessary
Power dissipation	< 1.055 W

Input data

Signal: Voltage

Number of inputs	1
Voltage input signal	19.2 V DC ... 30 V DC (24 V DC, -20 % ... +25 %)
Max. current input signal	65 mA (U _e = 24 V DC)

Output data

Signal: Voltage

Output description	intrinsically safe
Number of outputs	1
Output voltage	10 V DC (40 mA)
Output resistor	287 Ω (Internal resistance R _i)
Current limitation	40 mA
Response time	20 ms
Non-load voltage	21.9 V DC
Short-circuit-proof	yes

Connection data

Connection method	Screw connection
-------------------	------------------

MACX MCR-EX-SL-SD-21-40-LP - Solenoid driver



2865764

<https://www.phoenixcontact.com/us/products/2865764>

Stripping length	7 mm
Screw thread	M3
Conductor cross section rigid	0.2 mm ² ... 2.5 mm ²
Conductor cross section flexible	0.2 mm ² ... 2.5 mm ²
Conductor cross section AWG	24 ... 14
Tightening torque	0.5 Nm ... 0.6 Nm

Test socket

Max. diameter	2 mm
---------------	------

Ex data

Ex installation (EPL)	Gc
	Div. 2
Ex i circuits (EPL)	Ga
	Da
	Ma
	Div. 1

Safety data

Max. internal inductance L_i	negligible
Max. internal capacitance C_i	negligible
Max. output voltage U_o	25.1 V
Max. output current I_o	87 mA
Max. output power P_o	550 mW
Safety-related maximum voltage U_m	253 V AC
	125 V DC
IIB/IIIC (simple circuit): Max. external inductivity L_o / Max. external capacitance C_o	20 mH / 0.83 μ F
IIC (simple circuit): Max. external inductivity L_o / Max. external capacitance C_o	5 mH / 0.108 μ F
IIB/IIIC (mixed circuit): Max. external inductivity L_o / Max. external capacitance C_o	10 mH / 380 nF, 5 mH / 380 nF, 1 mH / 440 nF, 0.1 mH / 820 nF
IIC (mixed circuit): Max. external inductivity L_o / Max. external capacitance C_o	2 mH / 52 nF, 1 mH / 65 nF, 0.5 mH / 82 nF, 0.2 mH / 108 nF, 0.1 mH / 108 nF

Signaling

Status display	Yellow LED (switching state / status, lights up when output circuit is active)
----------------	--

Dimensions

Dimensional drawing	
---------------------	--

2865764

<https://www.phoenixcontact.com/us/products/2865764>

Width	12.5 mm
Height	112.5 mm
Depth	113.7 mm
Depth NS 35/7,5	114.5 mm (Snapped onto DIN rail NS 35/7,5 in accordance with EN 60715)

Material specifications

Color	gray (RAL 7042)
Flammability rating according to UL 94	V0 (Housing)
Housing material	PA 6.6-FR

Environmental and real-life conditions

Ambient conditions

Degree of protection	IP20 (not assessed by UL)
Ambient temperature (operation)	-40 °C ... 60 °C (Any mounting position)
Ambient temperature (storage/transport)	-40 °C ... 80 °C
Altitude	≤ 2000 m
Permissible humidity (operation)	10 % ... 95 % (non-condensing)

Approvals

CE

Certificate	CE-compliant
Note	and EN 61326

ATEX

Identification	⊕ II (1) G [Ex ia Ga] IIC/IIB/IIA
	⊕ II (1) D [Ex ia Da] IIIC
	⊕ II 3 (1)G Ex nA [ia IIC Ga] IIC T4 Gc X
Certificate	IBExU 07 ATEX 1133X

UKCA Ex (UKEX)

Identification	⊕ I (M1) [Ex ia Ma] I
	⊕ II (1) G [Ex ia Ga] IIC
	⊕ II (1) D [Ex ia Da] IIIC
	⊕ II 3 (1) Ex ec [ia Ga] IIC T4 Gc
Certificate	CML 22UKEX3526X

IECEX

Identification	[Ex ia Ga] IIC/IIB/IIA
	[Ex ia Da] IIIC
	Ex nA [ia IIC Ga] IIC T4 Gc
Certificate	IECEX IBE 08.0002X

CCC / China-Ex

	[Ex ia Ga] IIC
--	----------------

MACX MCR-EX-SL-SD-21-40-LP - Solenoid driver



2865764

<https://www.phoenixcontact.com/us/products/2865764>

Identification	[Ex iaD] Ex nA [ia Ga] IIC T4 Gc
Certificate	NEPSI GYJ20.1316X

UL, USA/Canada

Identification	UL 61010 Listed Class I, Div. 2, Groups A, B, C, D T4 Class I, Div. 2, Groups IIC, IIB, IIA T4 Associated apparatus for use in Class I, Division 1, Groups A,B,C,D Associated apparatus for use in Class II, Div.1 Groups E,F,G Associated apparatus for use in Class III, Division 1 Associated apparatus for use in Class I, Zone 0,1,2, Groups IIC,IIB,IIA
Certificate	UL C.D.-No 83104549

UL, USA/Canada

Identification	Class I Div 2; IS for Class I, II, III Div 1
Certificate	UL C.D.-No 83104549

Shipbuilding approval

Certificate	DNV GL TAA000020C
-------------	-------------------

Safety Integrity Level (SIL, IEC 61508)

Identification	3
----------------	---

INMETRO

Identification	[Ex ia Ga] IIC/IIB/IIA [Ex ia Da] IIIC Ex nA [ia IIC Ga] IIC T4 Gc
Certificate	DNV 18.0115 X

DNV GL data

Temperature	B
Humidity	B
Vibration	A
EMC	A
Enclosure	Required protection according to the Rules shall be provided upon installation on board

EMC data

Noise immunity	EN 61000-6-2
Electromagnetic compatibility	Conformance with EMC directive
Noise emission	EN 61000-6-4

Standards and regulations

Electrical isolation	2-way isolation
----------------------	-----------------

MACX MCR-EX-SL-SD-21-40-LP - Solenoid driver



2865764

<https://www.phoenixcontact.com/us/products/2865764>

GB Standard

Standards/regulations	GB 3836.1
	GB 3836.4
	GB 3836.8
	GB 3626.20
	GB 12476.1
	GB 12476.4

Mounting

Mounting type	DIN rail mounting
---------------	-------------------

Drawings

Diagram

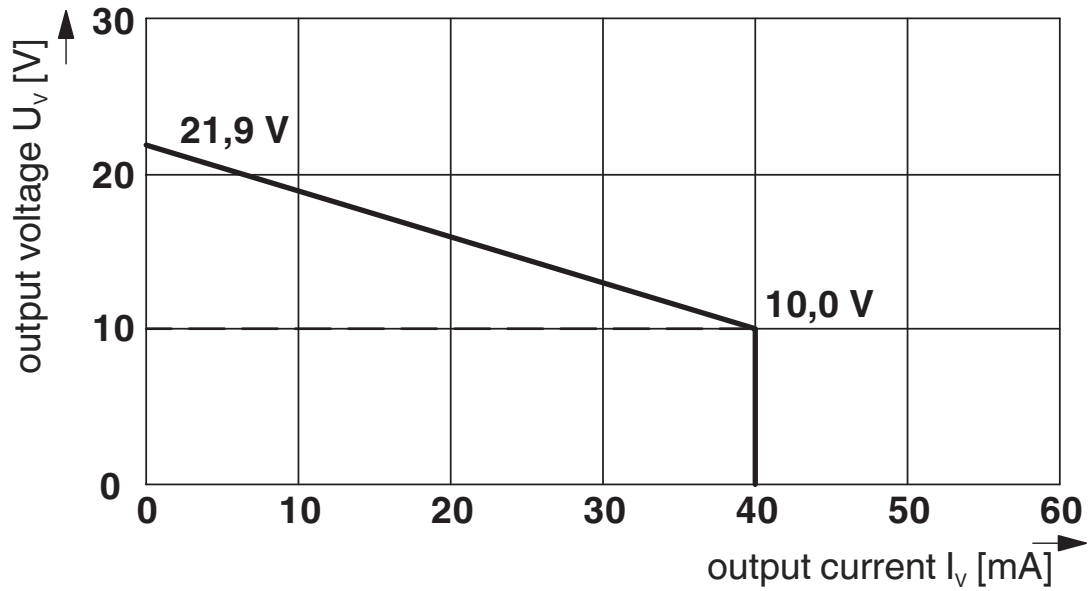

Dimensional drawing

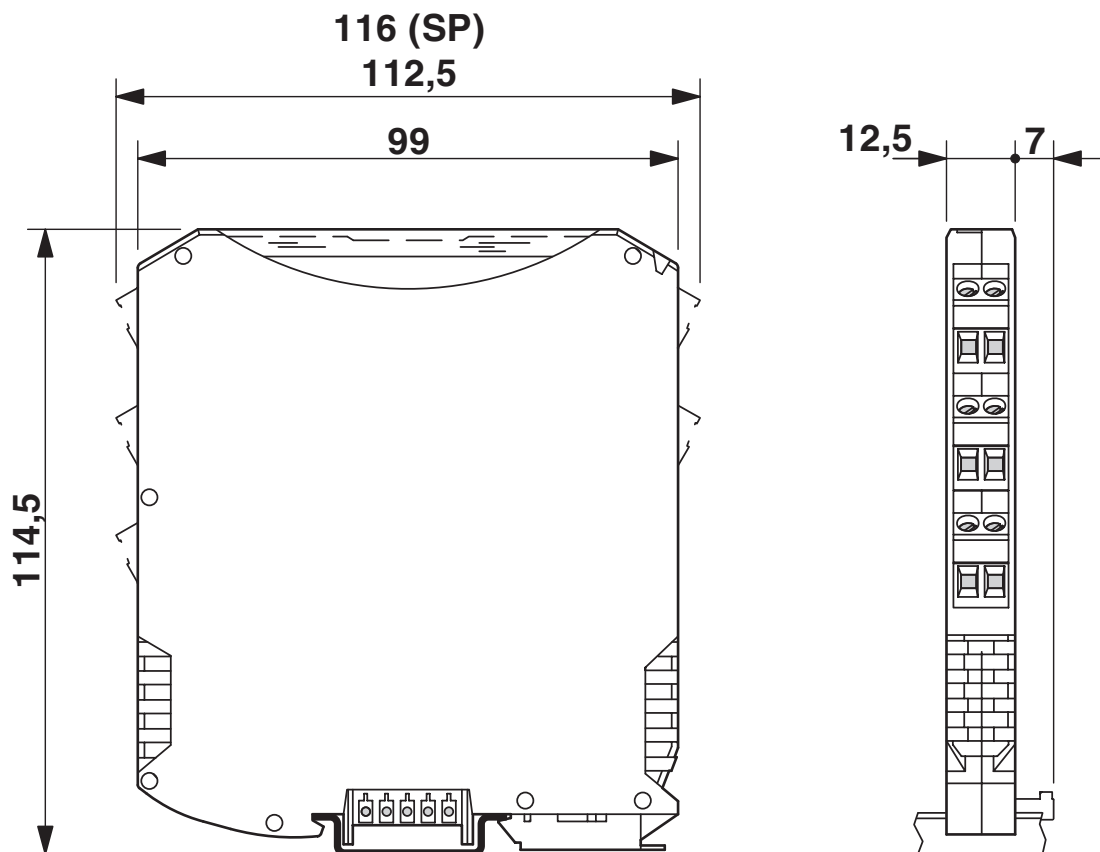

MACX MCR-EX-SL-SD-21-40-LP - Solenoid driver



2865764

<https://www.phoenixcontact.com/us/products/2865764>

Block diagram

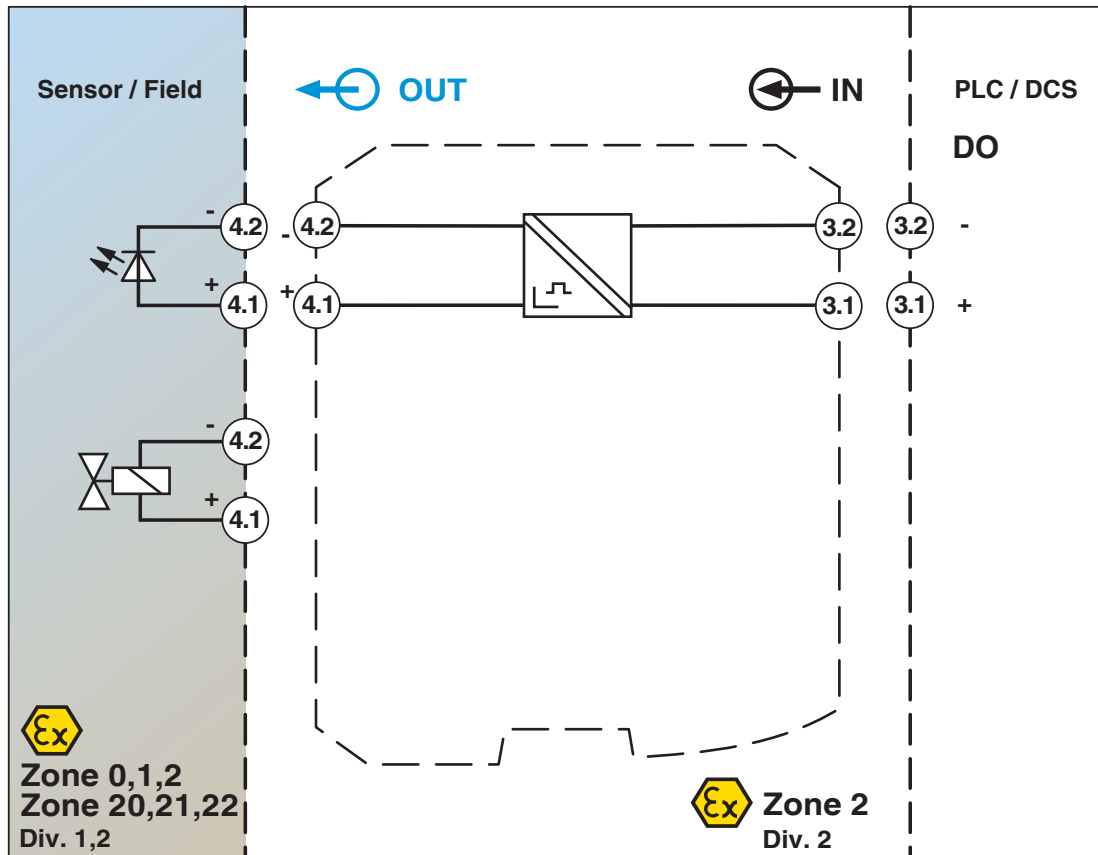

2865764

<https://www.phoenixcontact.com/us/products/2865764>

Approvals

To download certificates, visit the product detail page: <https://www.phoenixcontact.com/us/products/2865764>



DNV GL

Approval ID: TAA000020C



UL Listed

Approval ID: FILE E 330267



CCC

Approval ID: 2020322 316001457



cUL Listed

Approval ID: FILE E 330267

Functional Safety

Approval ID: 16/04-017 R025 V1R1



EAC Ex

Approval ID: RU C-DE.AB72.B.00093



IECEx

Approval ID: IECEx IBE 08.0002X



cUL Listed

Approval ID: FILE E 199827



UL Listed

Approval ID: FILE E 199827



ATEX

Approval ID: IBExU 07 ATEX 1133 X

INMETRO

Approval ID: DNV 18.0115 X

MACX MCR-EX-SL-SD-21-40-LP - Solenoid driver



2865764

<https://www.phoenixcontact.com/us/products/2865764>

cULus Listed

cULus Listed

MACX MCR-EX-SL-SD-21-40-LP - Solenoid driver



2865764

<https://www.phoenixcontact.com/us/products/2865764>

Classifications

ECLASS

ECLASS-11.0	27210120
ECLASS-12.0	27210120
ECLASS-13.0	27210120

ETIM

ETIM 9.0	EC002653
----------	----------

UNSPSC

UNSPSC 21.0	39121000
-------------	----------

2865764

<https://www.phoenixcontact.com/us/products/2865764>

Environmental product compliance

EU RoHS

Fulfills EU RoHS substance requirements	Yes
Exemption	7(a), 7(c)-I

China RoHS

Environment friendly use period (EFUP)	EFUP-50
	An article-related China RoHS declaration table can be found in the download area for the respective article under "Manufacturer declaration". For all articles with EFUP-E, no China RoHS declaration table issued and required.

EU REACH SVHC

REACH candidate substance (CAS No.)	Lead(CAS: 7439-92-1)
SCIP	e2ad2e0c-4f1a-4eb0-915c-9cd1054fdbf0

MACX MCR-EX-SL-SD-21-40-LP - Solenoid driver



2865764

<https://www.phoenixcontact.com/us/products/2865764>

Accessories

TC-D37SUB-ADIO16-EX-P-UNI - Module carrier

2924854

<https://www.phoenixcontact.com/us/products/2924854>



Universal termination carrier for connecting 16 MACX Analog Ex i signal conditioners to digital or analog I/O cards, via D-SUB connector, 37-pos. (1:1 connection)

MPS-IH WH - Insulating sleeve

0201663

<https://www.phoenixcontact.com/us/products/0201663>

Insulating sleeve, color: white



MACX MCR-EX-SL-SD-21-40-LP - Solenoid driver

2865764

<https://www.phoenixcontact.com/us/products/2865764>



MPS-IH RD - Insulating sleeve

0201676

<https://www.phoenixcontact.com/us/products/0201676>

Insulating sleeve, color: red



MPS-IH BU - Insulating sleeve

0201689

<https://www.phoenixcontact.com/us/products/0201689>

Insulating sleeve, color: blue

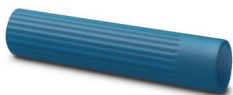

MACX MCR-EX-SL-SD-21-40-LP - Solenoid driver



2865764

<https://www.phoenixcontact.com/us/products/2865764>

MPS-IH YE - Insulating sleeve

0201692

<https://www.phoenixcontact.com/us/products/0201692>

Insulating sleeve, color: yellow



MPS-IH GN - Insulating sleeve

0201702

<https://www.phoenixcontact.com/us/products/0201702>

Insulating sleeve, color: green



MACX MCR-EX-SL-SD-21-40-LP - Solenoid driver

2865764

<https://www.phoenixcontact.com/us/products/2865764>



MPS-IH GY - Insulating sleeve

0201728

<https://www.phoenixcontact.com/us/products/0201728>

Insulating sleeve, color: gray



MPS-IH BK - Insulating sleeve

0201731

<https://www.phoenixcontact.com/us/products/0201731>

Insulating sleeve, color: black



MACX MCR-EX-SL-SD-21-40-LP - Solenoid driver



2865764

<https://www.phoenixcontact.com/us/products/2865764>

MPS-MT - Test plug

0201744

<https://www.phoenixcontact.com/us/products/0201744>



Test plug, with solder connection up to 1 mm² conductor cross section, number of positions: 1, color: gray

UC-EMLP (11X9) - Plastic label

0819291

<https://www.phoenixcontact.com/us/products/0819291>



Plastic label, Sheet, white, unlabeled, can be labeled with: BLUEMARK ID COLOR, BLUEMARK ID, BLUEMARK CLED, PLOTMARK, CMS-P1-PLOTTER, mounting type: adhesive, lettering field size: 11 x 9 mm, Number of individual labels: 10

MACX MCR-EX-SL-SD-21-40-LP - Solenoid driver



2865764

<https://www.phoenixcontact.com/us/products/2865764>

UC-EMLP (11X9) YE - Plastic label

0822602

<https://www.phoenixcontact.com/us/products/0822602>

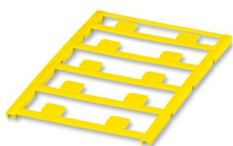

Plastic label, Sheet, yellow, unlabeled, can be labeled with: BLUEMARK ID COLOR, BLUEMARK ID, BLUEMARK CLED, PLOTMARK, CMS-P1-PLOTTER, mounting type: adhesive, lettering field size: 11 x 9 mm, Number of individual labels: 10

UC-EMLP (11X9) CUS - Plastic label

0824547

<https://www.phoenixcontact.com/us/products/0824547>



Plastic label, can be ordered: by sheet, white, labeled according to customer specifications, mounting type: adhesive, lettering field size: 11 x 9 mm

MACX MCR-EX-SL-SD-21-40-LP - Solenoid driver



2865764

<https://www.phoenixcontact.com/us/products/2865764>

UC-EMLP (11X9) YE CUS - Plastic label

0824548

<https://www.phoenixcontact.com/us/products/0824548>

Plastic label, can be ordered: by sheet, yellow, labeled according to customer specifications, mounting type: adhesive, lettering field size: 11 x 9 mm

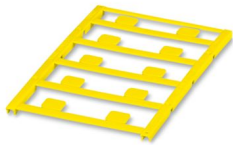

UC-EMLP (11X9) SR - Plastic label

0828094

<https://www.phoenixcontact.com/us/products/0828094>

Plastic label, Sheet, silver, unlabeled, can be labeled with: BLUEMARK ID COLOR, BLUEMARK ID, BLUEMARK CLED, PLOTMARK, CMS-P1-PLOTTER, mounting type: adhesive, lettering field size: 11 x 9 mm, Number of individual labels: 10



MACX MCR-EX-SL-SD-21-40-LP - Solenoid driver



2865764

<https://www.phoenixcontact.com/us/products/2865764>

UC-EMLP (11X9) SR CUS - Plastic label

0828098

<https://www.phoenixcontact.com/us/products/0828098>



Plastic label, can be ordered: by sheet, silver, labeled according to customer specifications, mounting type: adhesive, lettering field size: 11 x 9 mm, Number of individual labels: 10

US-EMLP (11X9) - Plastic label

0828789

<https://www.phoenixcontact.com/us/products/0828789>



Plastic label, Card, white, unlabeled, can be labeled with: BLUEMARK ID COLOR, BLUEMARK ID, THERMOMARK PRIME, THERMOMARK CARD 2.0, THERMOMARK CARD, mounting type: adhesive, lettering field size: 11 x 9 mm, Number of individual labels: 135

MACX MCR-EX-SL-SD-21-40-LP - Solenoid driver



2865764

<https://www.phoenixcontact.com/us/products/2865764>

US-EMLP (11X9) YE - Plastic label

0828871

<https://www.phoenixcontact.com/us/products/0828871>



Plastic label, Card, yellow, unlabeled, can be labeled with: BLUEMARK ID COLOR, BLUEMARK ID, THERMOMARK PRIME, THERMOMARK CARD 2.0, THERMOMARK CARD, mounting type: adhesive, lettering field size: 11 x 9 mm, Number of individual labels: 135

US-EMLP (11X9) SR - Plastic label

0828872

<https://www.phoenixcontact.com/us/products/0828872>



Plastic label, Card, silver, unlabeled, can be labeled with: BLUEMARK ID COLOR, BLUEMARK ID, THERMOMARK PRIME, THERMOMARK CARD 2.0, THERMOMARK CARD, mounting type: adhesive, lettering field size: 11 x 9 mm, Number of individual labels: 135

MACX MCR-EX-SL-SD-21-40-LP - Solenoid driver



2865764

<https://www.phoenixcontact.com/us/products/2865764>

LS-EMLP (11X9) WH - Device marker

0831678

<https://www.phoenixcontact.com/us/products/0831678>

Device marker, Sheet, white, unlabeled, can be labeled with: TOPMARK NEO, TOPMARK LASER, mounting type: adhesive, lettering field size: 11 x 9 mm, Number of individual labels: 255



LS-EMLP (11X9) SR - Device marker

0831705

<https://www.phoenixcontact.com/us/products/0831705>

Device marker, Sheet, silver, unlabeled, can be labeled with: TOPMARK NEO, TOPMARK LASER, mounting type: adhesive, lettering field size: 11 x 9 mm, Number of individual labels: 255

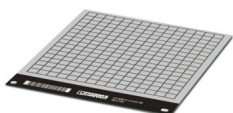

MACX MCR-EX-SL-SD-21-40-LP - Solenoid driver



2865764

<https://www.phoenixcontact.com/us/products/2865764>

LS-EMLP (11X9) YE - Device marker

0831732

<https://www.phoenixcontact.com/us/products/0831732>

Device marker, Sheet, yellow, unlabeled, can be labeled with: TOPMARK NEO, TOPMARK LASER, mounting type: adhesive, lettering field size: 11 x 9 mm, Number of individual labels: 255



MACX MCR-PTB - Power and error message module

2865625

<https://www.phoenixcontact.com/us/products/2865625>

Power and fault signaling module with screw connection, including corresponding ME 17,5 TBUS 1,5/ 5-ST-3,81 GY DIN rail connector



MACX MCR-EX-SL-SD-21-40-LP - Solenoid driver

2865764

<https://www.phoenixcontact.com/us/products/2865764>



MACX MCR-PTB-SP - Power and error message module

2924184

<https://www.phoenixcontact.com/us/products/2924184>



Power and fault signaling module with Push-in connection, including corresponding ME 17,5 TBUS 1,5/ 5-ST-3,81 GY DIN rail connector

QUINT4-SYS-PS/1AC/24DC/2.5/SC - Power supply unit

2904614

<https://www.phoenixcontact.com/us/products/2904614>



Primary-switched power supply, QUINT POWER, screw connection, DIN rail mounting, supply of devices possible via the TBUS DIN rail connector, protective coating, input: single-phase, output: 24 V DC/2.5 A

MACX MCR-EX-SL-SD-21-40-LP - Solenoid driver



2865764

<https://www.phoenixcontact.com/us/products/2865764>

SZS 0,6X3,5 - Screwdriver

1205053

<https://www.phoenixcontact.com/us/products/1205053>



Actuation tool, for ST terminal blocks, insulated, also suitable for use as a bladed screwdriver, size: 0.6 x 3.5 x 100 mm, 2-component grip, with non-slip grip

Phoenix Contact 2024 © - all rights reserved

<https://www.phoenixcontact.com>

Phoenix Contact USA
586 Fulling Mill Road
Middletown, PA 17057, United States
(+717) 944-1300
info@phoenixcon.com