

Features

- Qualified for Automotive Applications
 - AEC-Q100 Grade 1, T_A : -40°C to $+125^{\circ}\text{C}$
- Input Voltage Range: 2.5 V to 20 V
- Output Voltage Range:
 - Adjustable Output: 1.22 V to 18 V
- $\pm 2\%$ Output Accuracy Over Line Regulation, Load Regulation, and Operating Temperature Range
- 300-mA Maximum Output Current
- Low Dropout Voltage: 600 mV Maximum at 300 mA
- High PSRR:
 - 96 dB at 1 kHz
 - 71 dB at 100 kHz
 - 51 dB at 1 MHz
- 5.2- μVRMS Output Voltage Noise
- Excellent Transient Response
- Stable with $\geq 2.2\text{-}\mu\text{F}$ Low ESR Ceramic Output Capacitor
- Integrated Protection:
 - Over-current Protection
 - Over-temperature Protection
- ESOP8 Package

Applications

- Automotive Surround View Camera
- High-definition Imaging System
- Infrared Image Equipment

Description

The TPL8032Q product is a 300-mA high PSRR, ultra-low noise, low dropout linear regulator with 20-V wide input voltage range. The TPL8032Q product supports adjustable output voltage ranging from 1.22 V to 18 V with an external resistor divider and is stable with a 2.2- μF or larger ceramic output capacitor.

The TPL8032Q product features high PSRR with 96 dB at 1 kHz and 5.2- μVRMS ultra-low noise. These features make the TPL8032Q product suitable for noise-sensitive applications with large ripple and noise generated from the previous stage power supply, such as high-performance analog devices or high-definition imaging equipment. The output shortage protection and thermal overload-protection circuits improve the reliability under heavy load conditions.

The TPL8032Q product provides a thermal-enhanced ESOP8 package with guaranteed operating ambient temperature ranging from -40°C to $+125^{\circ}\text{C}$.

Typical Application Circuit

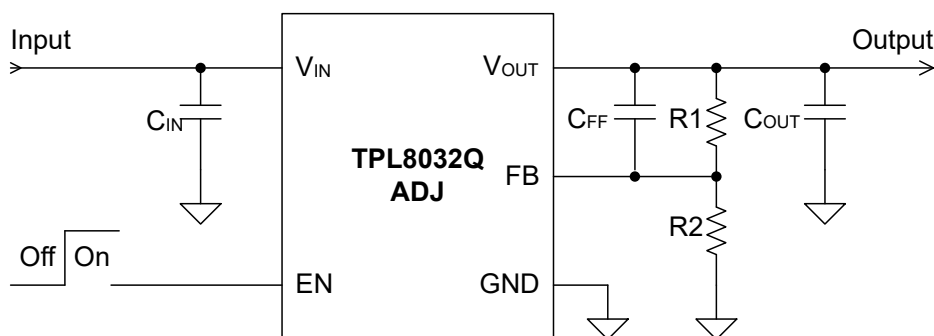

Table of Contents

Features	1
Applications	1
Description	1
Typical Application Circuit	1
Product Family Table	3
Revision History	3
Pin Configuration and Functions	4
Specifications	5
Absolute Maximum Ratings ⁽¹⁾	5
ESD, Electrostatic Discharge Protection.....	5
Recommended Operating Conditions.....	5
Thermal Information.....	5
Electrical Characteristics.....	6
Typical Performance Characteristics.....	8
Detailed Description	14
Overview.....	14
Functional Block Diagram.....	14
Feature Description.....	14
Application and Implementation	16
Application Information	16
Typical Application.....	16
Layout	18
Layout Guideline.....	18
Tape and Reel Information	19
Package Outline Dimensions	20
ESOP8.....	20
Order Information	21
IMPORTANT NOTICE AND DISCLAIMER	22

Product Family Table

Order Number	Output Voltage (V)	Package
TPL8032ADQ-ES1R-S	Adjustable (1.22 V to 18 V)	ESOP8

Revision History

Date	Revision	Notes
2021-12-31	Rev.Pre.0	Preliminary Revision.
2022-11-30	Rev.A.0	Initial Released.
2023-05-31	Rev.A.1	Corrected X-axis Title of Figure 9, Figure 10, Figure 11 and Figure 12.
2023-10-10	Rev.A.2	Added the Tolerance of V_{FB} .
2024-02-20	Rev.A.3	Removed Output Reverse Current Protection Feature.

Pin Configuration and Functions

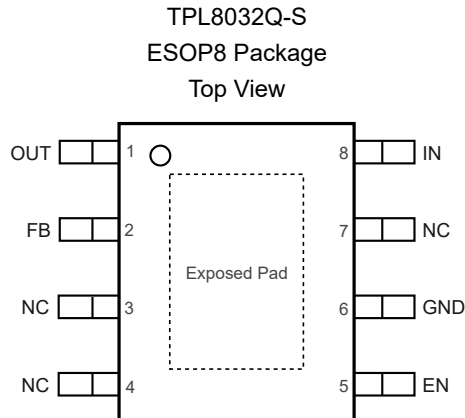

Table 1. Pin Functions: TPL8032Q-S

Pin No.	Pin Name	I/O	Description
5	EN	I	Regulator enable pin. Drive EN high to turn on the regulator; and drive EN low to turn off the regulator.
2	FB	I	Output voltage feedback pin. Connect to a resistor divider to adjust the output voltage.
6	GND	-	Ground reference pin. Connect the GND pin to PCB ground plane directly.
8	IN	I	Input voltage pin.
3, 4, 7	NC	-	No connection.
1	OUT	O	Regulated output voltage pin.

Specifications

Absolute Maximum Ratings ⁽¹⁾

Parameter		Min	Max	Unit
EN, IN		-0.3	24	V
OUT		-0.3	24	V
FB		-0.3	6	V
T _J	Junction Temperature Range	-40	150	°C
T _{STG}	Storage Temperature Range	-65	150	°C
T _L	Lead Temperature (Soldering 10 sec)		260	°C

(1) Stresses beyond those listed under Absolute Maximum Ratings may cause permanent damage to the device. Exposure to any Absolute Maximum Rating condition for extended periods may affect device reliability and lifetime.

ESD, Electrostatic Discharge Protection

Symbol	Parameter	Condition	Minimum Level	Unit
HBM	Human Body Model ESD	AEC Q100-002	±2	kV
CDM	Charged Device Model ESD	AEC Q100-011	±1.5	kV

(1) JEDEC document JEP155 states that 500-V HBM allows safe manufacturing with a standard ESD control process.

(2) JEDEC document JEP157 states that 250-V CDM allows safe manufacturing with a standard ESD control process.

Recommended Operating Conditions

Parameter		Min	Max	Unit
IN		2.5	20	V
EN		0	V _{IN}	V
COUT		2.2		μF
ESR		1	100	mΩ
T _A	Ambient Temperature Range	-40	125	°C
T _J	Junction Temperature Range	-40	150	°C

Thermal Information

Package Type	θ _{JA}	θ _{JC,top}	θ _{JC,bottom}	Unit
ESOP8	39.6	83.1	14.3	°C/W

20-V/300-mA Wide-input High-PSRR Ultra-low Noise LDO Regulator
Electrical Characteristics

All test conditions: $V_{IN} = V_{IN,MIN} = V_{OUT(NOM)} + 1\text{ V}$ or 2.5 V , whichever is greater, $-40^{\circ}\text{C} \leq T_A \leq +125^{\circ}\text{C}$; typically, $V_{OUT} = 5\text{ V}$, $C_{IN} = 10\text{ }\mu\text{F}$, $C_{OUT} = 4.7\text{ }\mu\text{F}$, and $C_{FF} = 100\text{ nF}$ for adjustable output, unless otherwise noted.

Symbol	Parameter	Conditions	Min	Typ	Max	Unit
Supply Input Voltage and Current						
V_{IN}	Input Supply Voltage Range ⁽¹⁾		$V_{IN,MIN}$		20	V
UVLO	Input Supply Voltage Rising			2.25	2.4	V
	Hysteresis			0.2		V
I_{GND}	Ground Pin Current	$I_{OUT} = 0\text{ mA}$		96	160	μA
		$I_{OUT} = 10\text{ mA}$		450		μA
I_{SHDN}	Shutdown Current	EN = GND		2	8	μA
Enable Input Voltage and Current						
$V_{IH(EN)}$	EN Input High Level (Enable)		1.6		V_{IN}	V
$V_{IL(EN)}$	EN Input Low Level (Disable)		0		0.5	V
I_{EN}	EN Pin Leakage Current	$V_{EN} = 0\text{ V to }20\text{ V}$		0.5	1	μA
Regulated Output Voltage and Current						
V_{OUT}	Output Voltage Accuracy ⁽²⁾	$I_{OUT} = 1\text{ mA to }300\text{ mA}$	-2%		2%	
V_{FB}	Feedback Pin Voltage		1.196	1.22	1.245	V
I_{FB}	FB Input Current	Force $V_{FB} = 1.5\text{ V}$	-100		100	nA
ΔV_{OUT}	Line Regulation	$V_{IN} = V_{IN,MIN}$ to 20 V , $I_{OUT} = 1\text{ mA}$		0.007		%/V
	Load Regulation	$V_{IN} = V_{IN,MIN}$, $I_{OUT} = 1\text{ mA to }300\text{ mA}$		0.01		%/mA
V_{DO}	Dropout Voltage ⁽³⁾	$I_{OUT} = 100\text{ mA}$		125	200	mV
		$I_{OUT} = 200\text{ mA}$		250	400	mV
		$I_{OUT} = 300\text{ mA}$		375	600	mV
I_{OUT}	Output Voltage	V_{OUT} in regulation	0		300	mA
I_{LIM}	Output Current Limit	$V_{OUT} = 0.9 \times V_{OUT(NOM)}$	310	450	650	mA
I_{SC}	Short-Circuit to Ground Current Limit	V_{OUT} is forced to GND, $T_J = 25^{\circ}\text{C}$		180		mA
PSRR	Power Supply Rejection Ratio	$C_{OUT} = 2.2\text{ }\mu\text{F}$, $C_{FF} = 100\text{ nF}$, $I_{OUT} = 100\text{ mA}$, $f = 120\text{ Hz}$		88		dB
		$C_{OUT} = 2.2\text{ }\mu\text{F}$, $C_{FF} = 100\text{ nF}$, $I_{OUT} = 100\text{ mA}$, $f = 1\text{ kHz}$		96		dB
		$C_{OUT} = 2.2\text{ }\mu\text{F}$, $C_{FF} = 100\text{ nF}$, $I_{OUT} = 100\text{ mA}$, $f = 100\text{ kHz}$		71		dB
		$C_{OUT} = 2.2\text{ }\mu\text{F}$, $C_{FF} = 100\text{ nF}$, $I_{OUT} = 100\text{ mA}$, $f = 1\text{ MHz}$		51		dB

20-V/300-mA Wide-input High-PSRR Ultra-low Noise LDO Regulator

Symbol	Parameter	Conditions	Min	Typ	Max	Unit
V_N	Output Noise Voltage	$C_{OUT} = 2.2 \mu F$, $C_{FF} = 100 \text{ nF}$, $I_{OUT} = 100 \text{ mA}$, $BW = 10 \text{ Hz to } 100 \text{ kHz}$		5.2		μVRMS
Temperature Range						
T_{SD}	Thermal Shutdown Temperature Threshold			160		$^{\circ}\text{C}$
	Hysteresis			20		$^{\circ}\text{C}$

(1) $V_{IN,MIN} = V_{OUT(NOM)} + 1 \text{ V}$ or 2.5 V , whichever is greater.

(2) Tolerance of external resistor is not included.

(3) Dropout voltage is the minimum input to the output voltage differential needed to maintain regulation at a specified output current and measure for $V_{OUT(NOM)} \geq 3.3 \text{ V}$. In the dropout mode, the output voltage will be equal to: $V_{IN} - V_{DO}$.

Typical Performance Characteristics

All test conditions: $V_{IN} = V_{OUT(NOM)} + 1\text{ V}$ or 2.5 V , whichever is greater, $-40^{\circ}\text{C} \leq T_A \leq +125^{\circ}\text{C}$; typically, $V_{OUT} = 5\text{ V}$, $C_{IN} = 10\text{ }\mu\text{F}$, $C_{OUT} = 2.2\text{ }\mu\text{F}$, and $C_{FF} = 100\text{ nF}$ for adjustable output, unless otherwise noted.

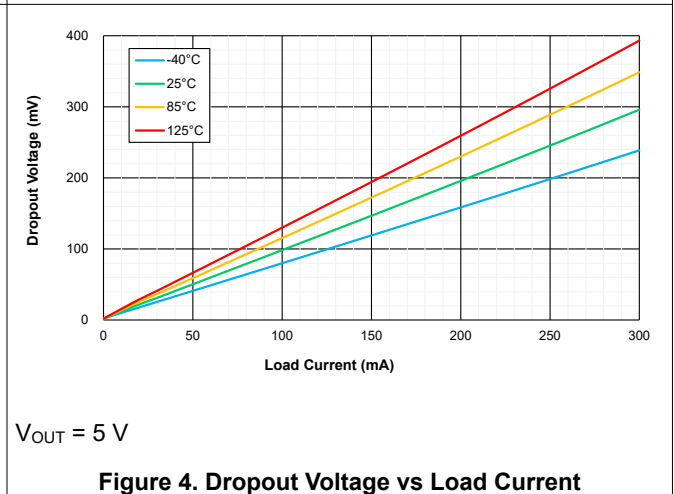
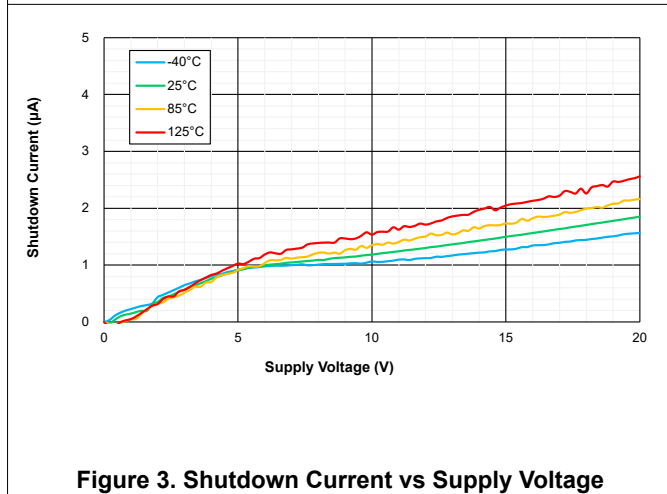
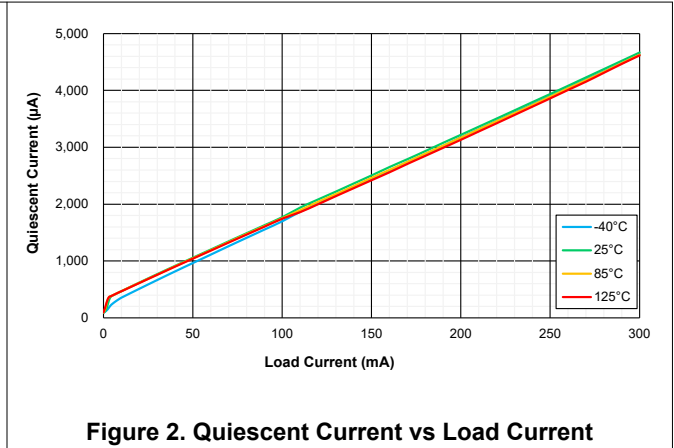
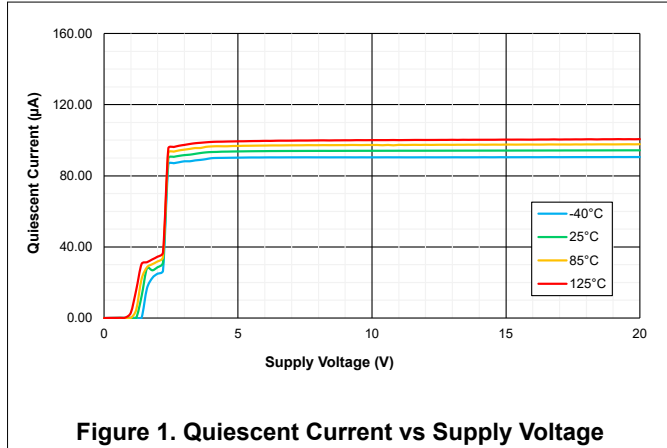

$V_{OUT} = 5\text{ V}$

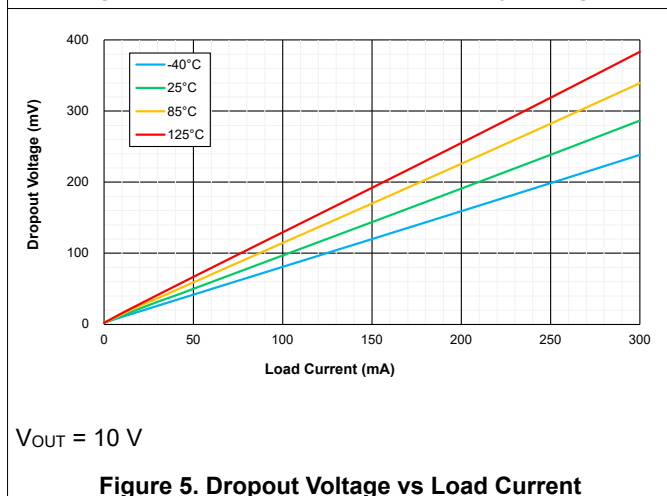

$V_{OUT} = 10\text{ V}$

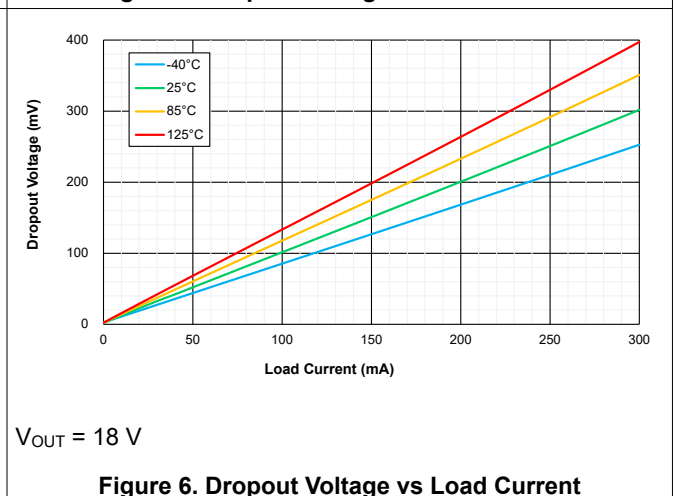

$V_{OUT} = 18\text{ V}$

20-V/300-mA Wide-input High-PSRR Ultra-low Noise LDO Regulator

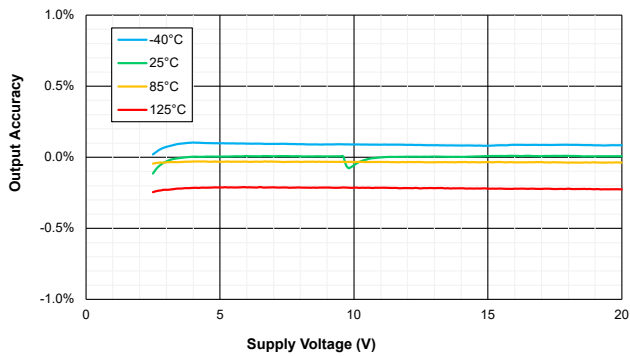

$V_{OUT} = 1.22\text{ V}$

Figure 7. Line Regulation

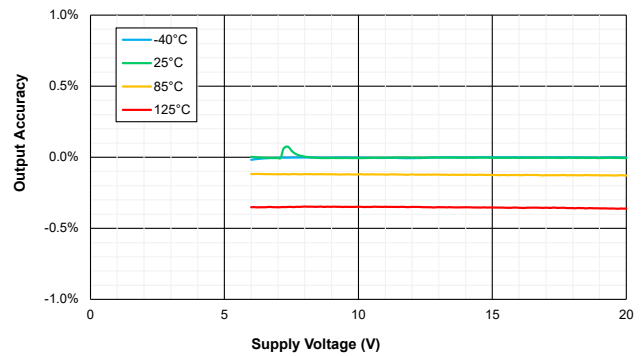

$V_{OUT} = 5\text{ V}$

Figure 8. Line Regulation

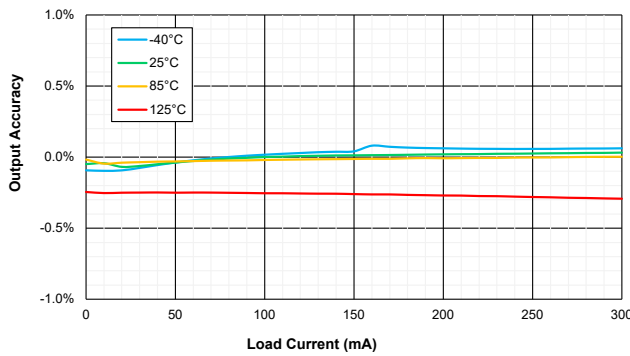

$V_{OUT} = 1.22\text{ V}$

Figure 9. Load Regulation

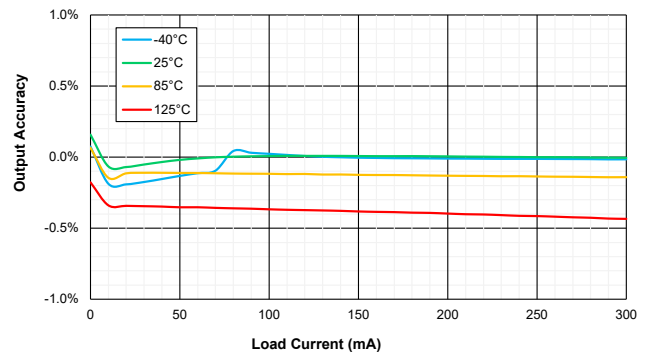

$V_{OUT} = 5\text{ V}$

Figure 10. Load Regulation

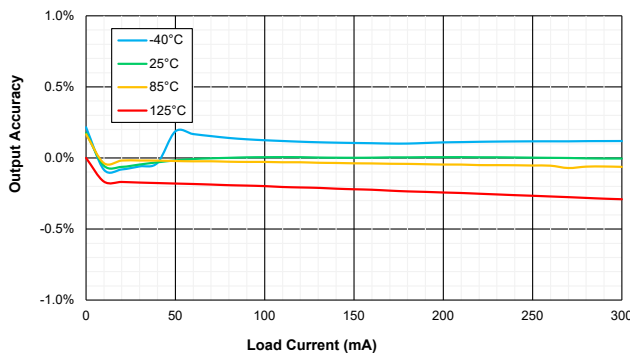

$V_{OUT} = 10\text{ V}$

Figure 11. Load Regulation

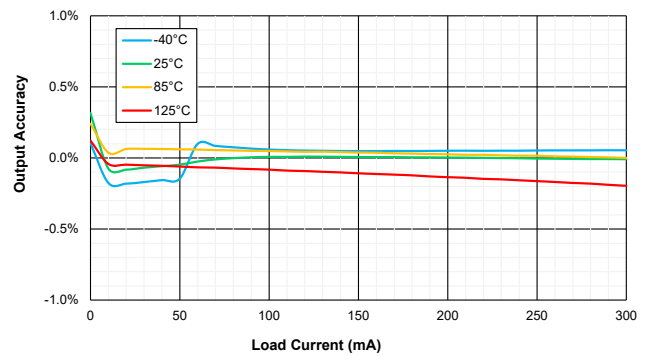

$V_{OUT} = 18\text{ V}$

Figure 12. Load Regulation

20-V/300-mA Wide-input High-PSRR Ultra-low Noise LDO Regulator

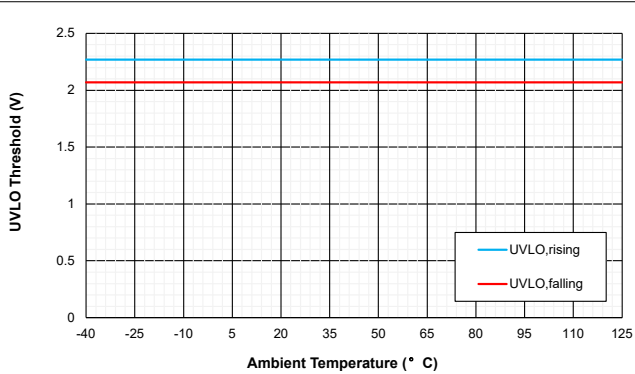

Figure 13. UVLO

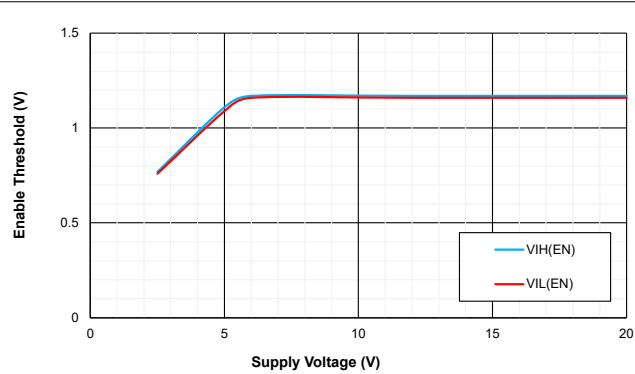

Figure 14. EN Threshold

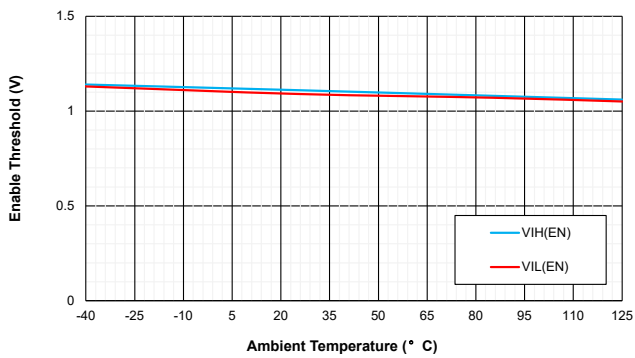
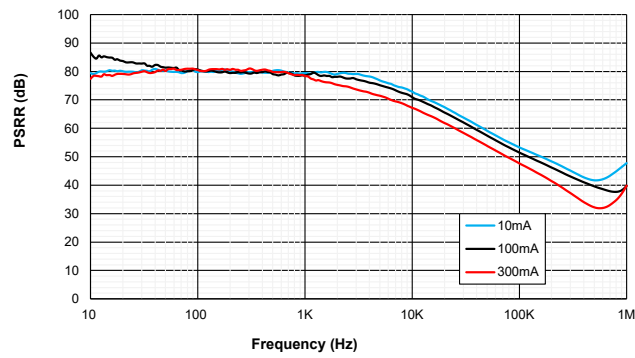
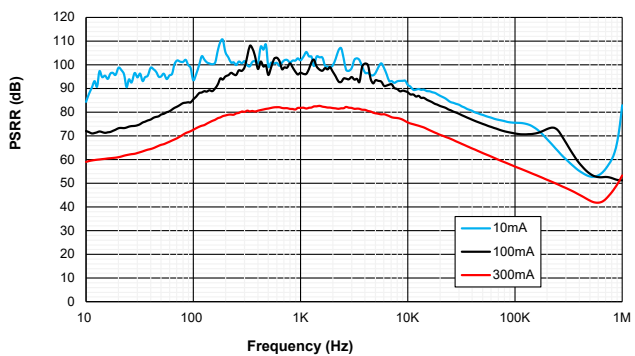

Figure 15. EN Threshold



$V_{OUT} = 1.22\text{ V}$

Figure 16. PSRR



$V_{OUT} = 5\text{ V}$

Figure 17. PSRR

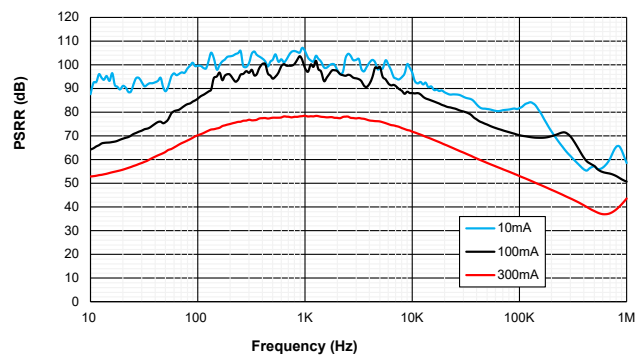

$V_{OUT} = 10\text{ V}$

Figure 18. PSRR

20-V/300-mA Wide-input High-PSRR Ultra-low Noise LDO Regulator

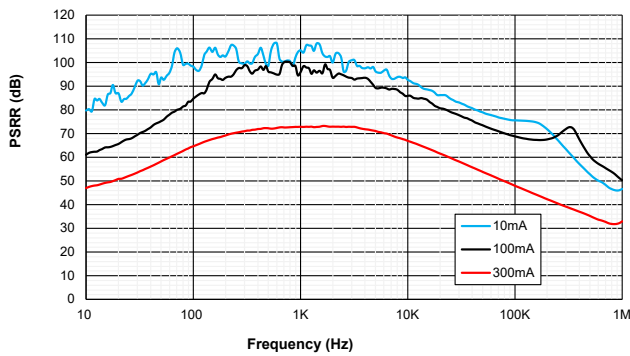

$V_{OUT} = 18\text{ V}$

Figure 19. PSRR

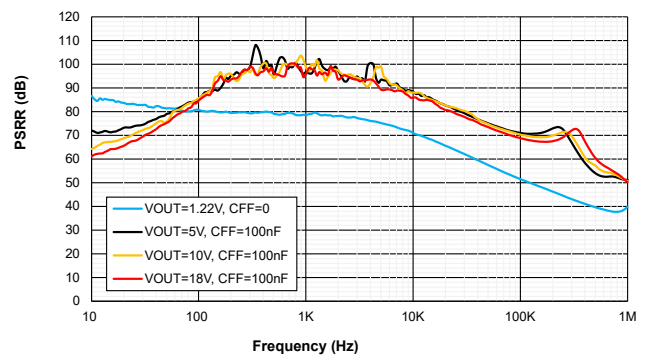
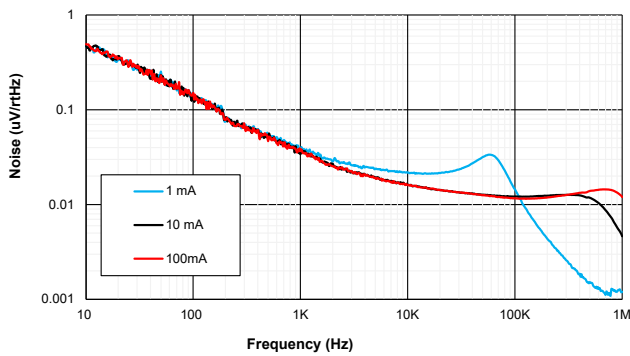
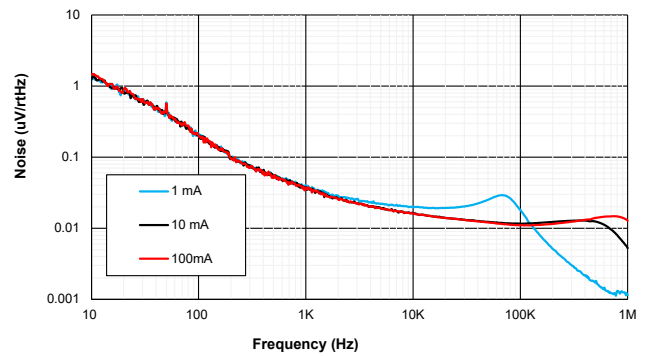

Figure 20. PSRR



$V_{OUT} = 1.22\text{ V}$

Figure 21. Noise



$V_{OUT} = 5\text{ V}$

Figure 22. Noise

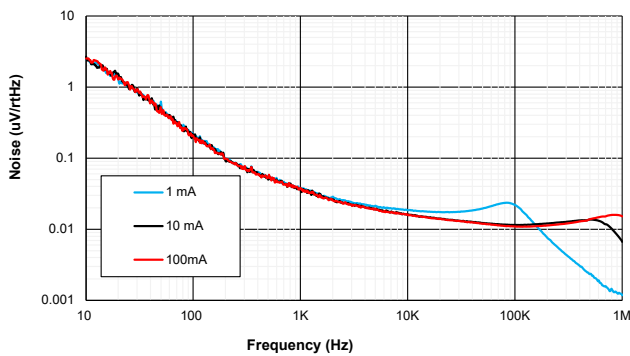

$V_{OUT} = 10\text{ V}$

Figure 23. Noise

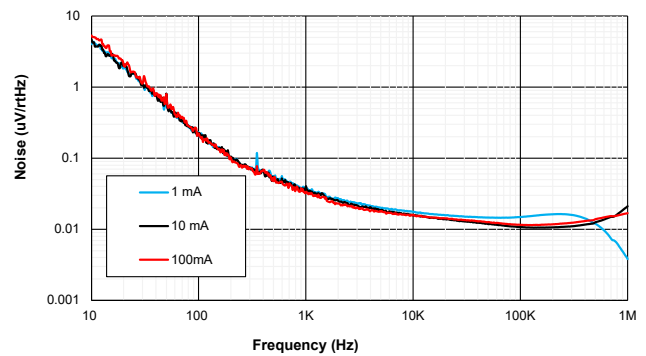

$V_{OUT} = 18\text{ V}$

Figure 24. Noise

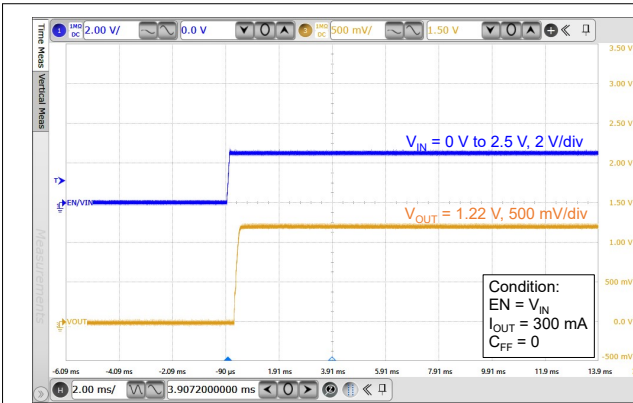

$V_{OUT} = 1.22\text{ V}$

Figure 25. Startup with V_{IN}

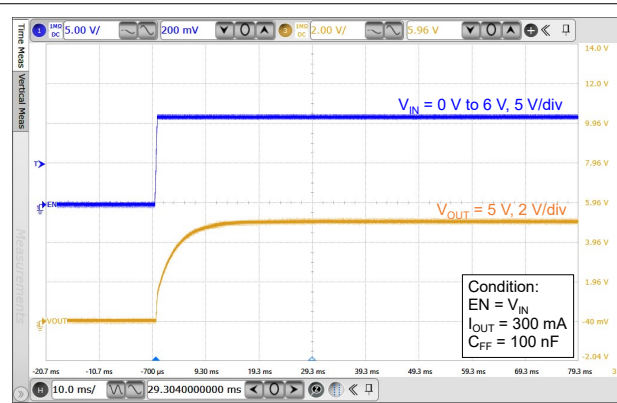

$V_{OUT} = 5\text{ V}$

Figure 26. Startup with V_{IN}

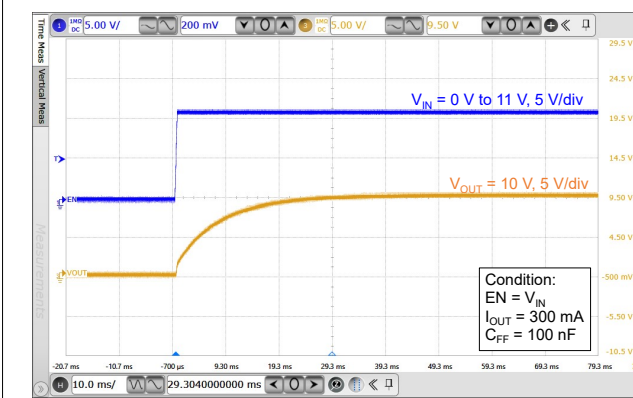

$V_{OUT} = 10\text{ V}$

Figure 27. Startup with V_{IN}

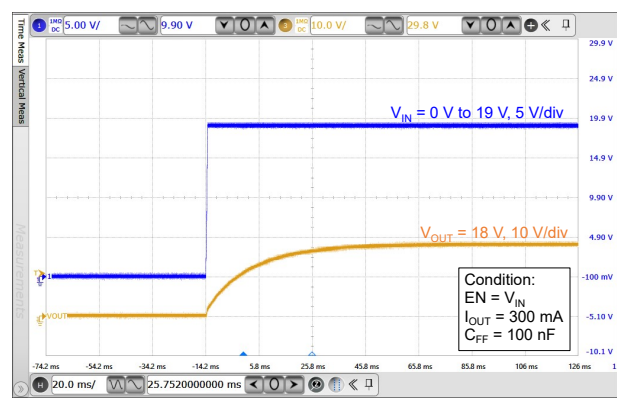

$V_{OUT} = 18\text{ V}$

Figure 28. Startup with V_{IN}

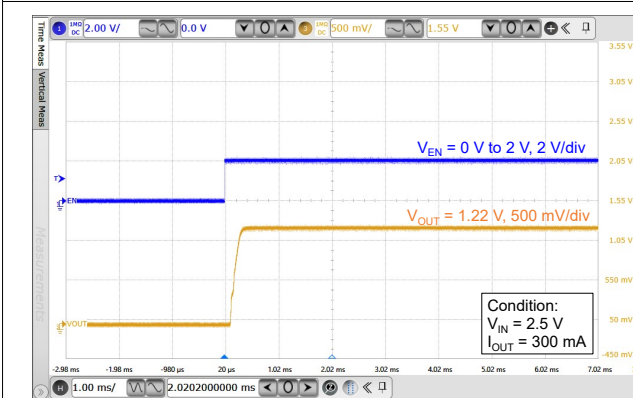

$V_{OUT} = 1.22\text{ V}$

Figure 29. Startup with V_{EN}

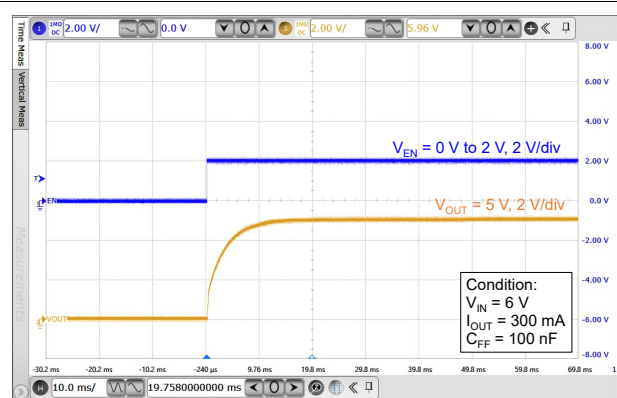

$V_{OUT} = 5\text{ V}$

Figure 30. Startup with V_{EN}

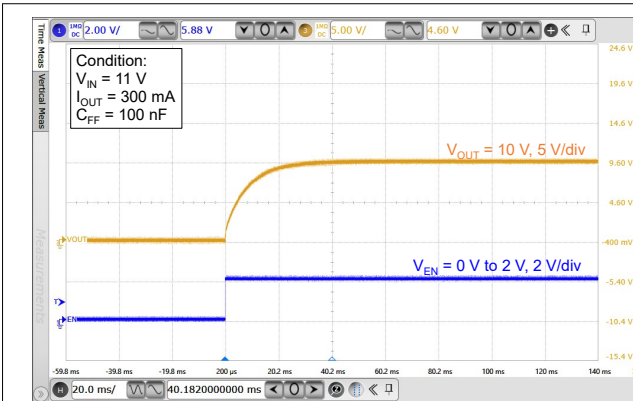
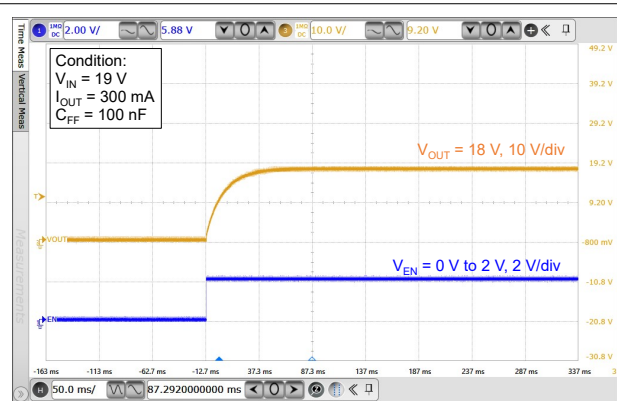
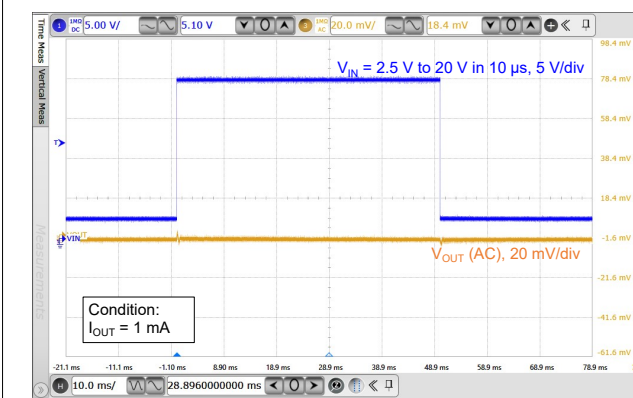
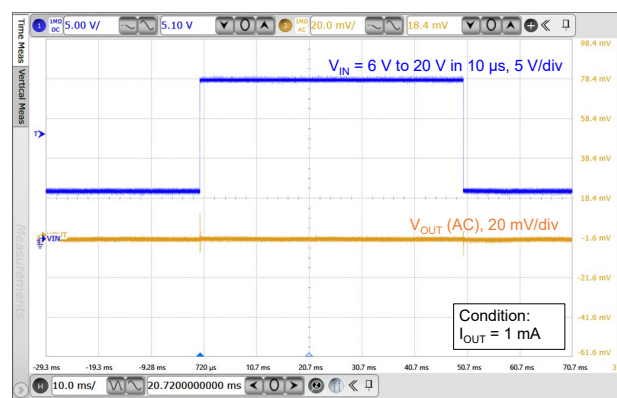
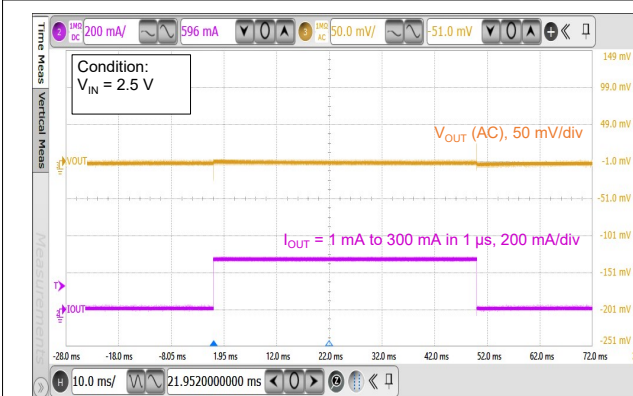
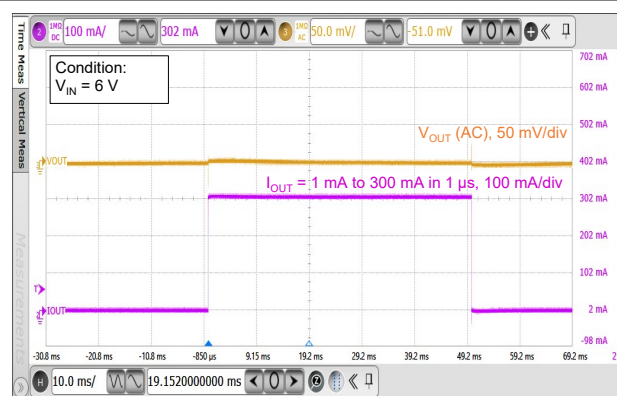
20-V/300-mA Wide-input High-PSRR Ultra-low Noise LDO Regulator

 $V_{OUT} = 10\text{ V}$
Figure 31. Startup with V_{EN}

 $V_{OUT} = 18\text{ V}$
Figure 32. Startup with V_{EN}

 $V_{OUT} = 1.22\text{ V}$
Figure 33. Line Transient

 $V_{OUT} = 5\text{ V}$
Figure 34. Line Transient

 $V_{OUT} = 1.22\text{ V}$
Figure 35. Load Transient

 $V_{OUT} = 5\text{ V}$
Figure 36. Load Transient

Detailed Description

Overview

The TPL8032Q product is a 300-mA high PSRR, ultra-low noise, low dropout linear regulator with 20-V wide input voltage range. The TPL8032Q product supports adjustable output voltage ranging from 1.22 V to 18 V with an external resistor divider and is stable with a 2.2- μ F or larger ceramic output capacitor.

The TPL8032Q product features high PSRR with 96 dB at 1 kHz and 5.2- μ V_{RMS} ultra-low noise. These features make the TPL8032Q product suitable for noise-sensitive applications with large ripple and noise generated from the previous stage power supply, such as high-performance analog devices or high-definition imaging equipment. Output shortage protection and thermal overload-protection circuits improve the reliability under heavy load conditions.

Functional Block Diagram

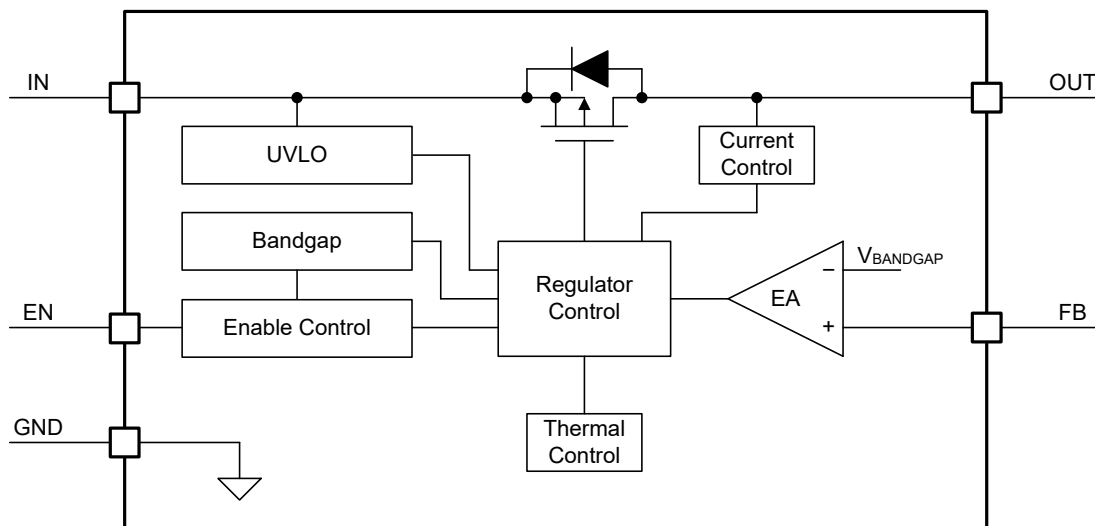

Figure 37. Functional Block Diagram

Feature Description

Enable (EN)

The enable pin (EN) is active high. Connect this pin to the GPIO of an external processor or digital logic control circuit to enable and disable the device. Or connect this pin to the IN pin for self-bias applications.

Under-Voltage Lockout (UVLO)

The TPL8032Q product uses an under-voltage lockout circuit to keep the output shut off until the internal circuitry operates properly. Refer to the [Electrical Characteristics](#) table for UVLO threshold and hysteresis.

20-V/300-mA Wide-input High-PSRR Ultra-low Noise LDO Regulator

Adjustable Output Voltage (FB and OUT)

The output voltage range of the TPL8032Q product can be set from 1.22 V to 18 V by selecting different external resistors. Use the [Equation 1](#) to calculate the output voltage.

$$V_{\text{OUT}} = V_{\text{FB}} \times \left(1 + \frac{R_1}{R_2}\right) \quad (1)$$

Where, the feedback voltage V_{FB} is 1.22 V.

Over-Current Protection and Short-to-Ground Protection

The TPL8032Q product integrates an internal current limit that helps to protect the regulator during fault conditions.

- When the output voltage is pulled down below the regulated voltage, over-current protection starts to work and limit the output current to I_{LIM} .
- When the output voltage is pulled down below the short-to-ground threshold, or shorted to ground directly, short-to-ground protection starts to work and limit the output current to I_{SC} .
- During startup, the output current is limited to I_{SC} before the output voltage ramps higher than the short-to-ground threshold.

Under the over-current conditions, the internal junction temperature ramps up quickly. When the junction temperature is high enough, it will cause the over-temperature protection.

Over-Temperature Protection

The over-temperature protection starts to work when the junction temperature exceeds the thermal shutdown (TSD) threshold, which turns off the regulator immediately. Until when the device cools down and the junction temperature falls below a value, which equals to thermal shutdown threshold minus thermal shutdown hysteresis, the regulator turns on again.

The junction temperature range should be limited according to the [Recommended Operating Conditions](#) table. Continuously operating above the junction temperature range will reduce the device lifetime.

Application and Implementation

Note

Information in the following application sections is not part of the 3PEAK's component specification and 3PEAK does not warrant its accuracy or completeness. 3PEAK's customers are responsible for determining suitability of components for their purposes. Customers should validate and test their design implementation to confirm system functionality.

Application Information

The TPL8032Q product is a series of 20-V 300-mA high-PSRR, ultra-low noise, low-dropout linear regulator. The following application schematic shows a typical usage of the TPL8032Q series.

Typical Application

The figure below shows the typical application schematic of the TPL8032Q product.

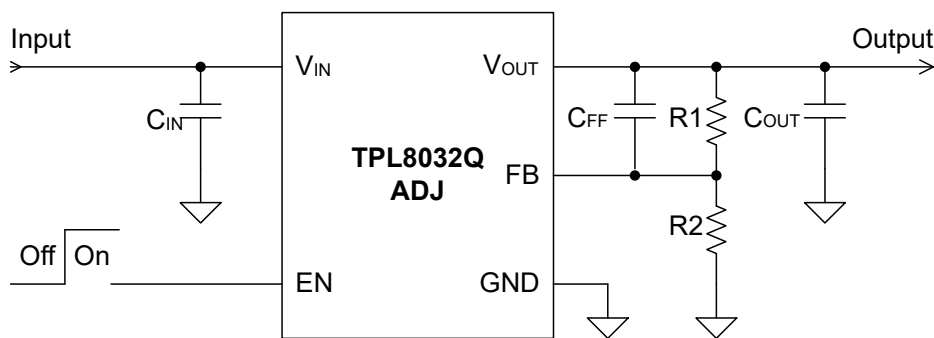

Figure 38. Typical Application Circuit

Input Capacitor and Output Capacitor

3PEAK recommends adding a 10-μF or greater capacitor with a 0.1-μF bypass capacitor in parallel at the IN pin to keep the input voltage stable. The voltage rating of the capacitors must be greater than the maximum input voltage.

To ensure loop stability, the TPL8032Q series requires an output capacitor of 2.2 μF or greater. 3PEAK recommends selecting an X7R type 10-μF ceramic capacitor with low ESR over temperature.

Both input capacitors and output capacitors must be placed as close to the device pins as possible.

Power Dissipation and Thermal Consideration

During normal operation, LDO junction temperature should meet the requirement in the [Recommended Operating Conditions](#) table. Using below equations to calculate the power dissipation and estimate the junction temperature.

The power dissipation can be calculated using the [Equation 2](#).

$$P_D = (V_{IN} - V_{OUT}) \times I_{OUT} + V_{IN} \times I_{GND} \tag{2}$$

The junction temperature can be estimated using the [Equation 3](#). θ_{JA} is the junction-to-ambient thermal resistance.

20-V/300-mA Wide-input High-PSRR Ultra-low Noise LDO Regulator

$$T_J = T_A + P_D \times \theta_{JA}$$

(3)

Layout

Layout Guideline

- Both input capacitors and output capacitors must be placed to the device pins as close as possible, and the vias between capacitors and device power pins must be avoided.
- It is recommended to bypass the input pin to ground with a 0.1- μ F bypass capacitor. The loop area formed by the bypass capacitor connection, the IN pin and the GND pin of the system must be as small as possible.
- It is recommended to use wide and thick copper to minimize I \times R drop and heat dissipation.
- Exposed pad must be connected to the PCB ground plane directly, the copper area must be as large as possible.

Tape and Reel Information

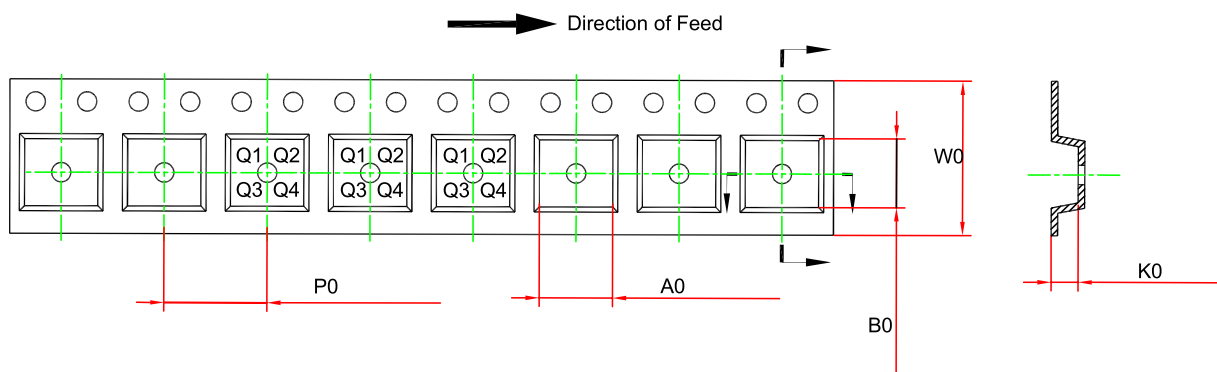
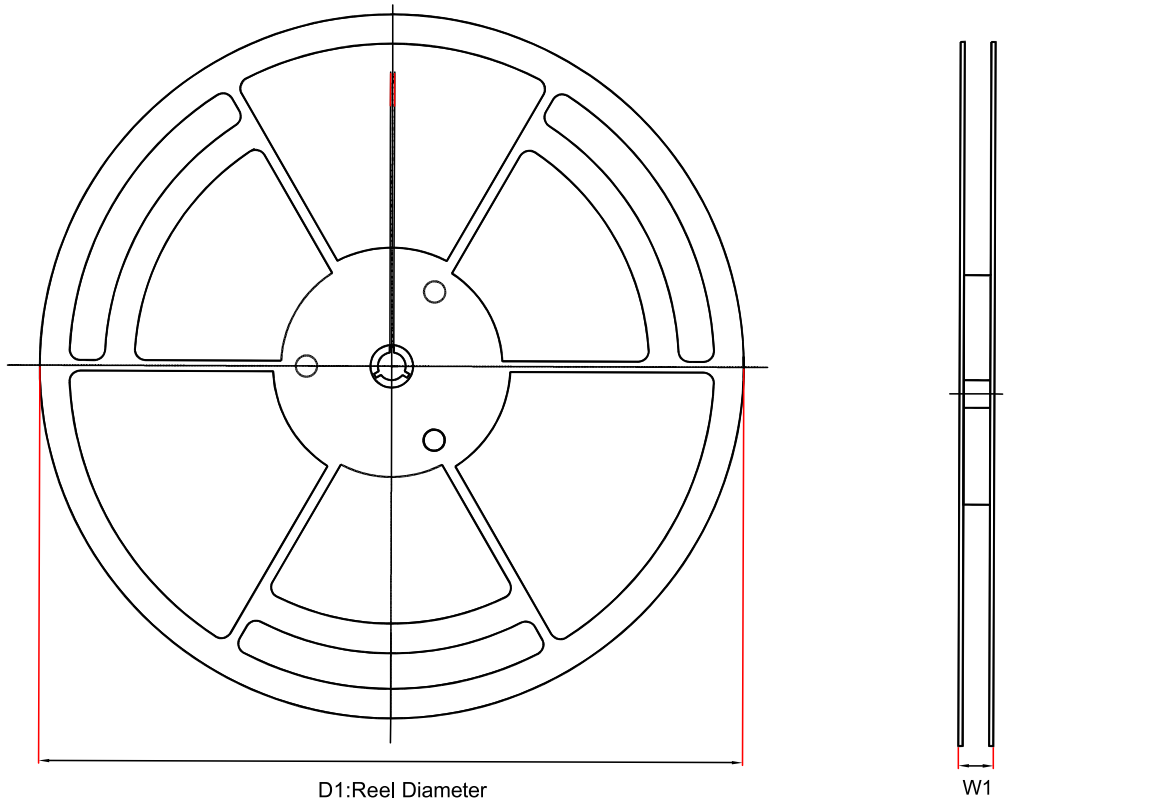

Order Number	Package	D1 (mm)	W1 (mm)	A0 (mm)	B0 (mm)	K0 (mm)	P0 (mm)	W0 (mm)	Pin1 Quadrant
TPL8032ADQ-ES1R-S	ESOP-8	330	17.6	6.4	5.4	2.1	8	12	Q1

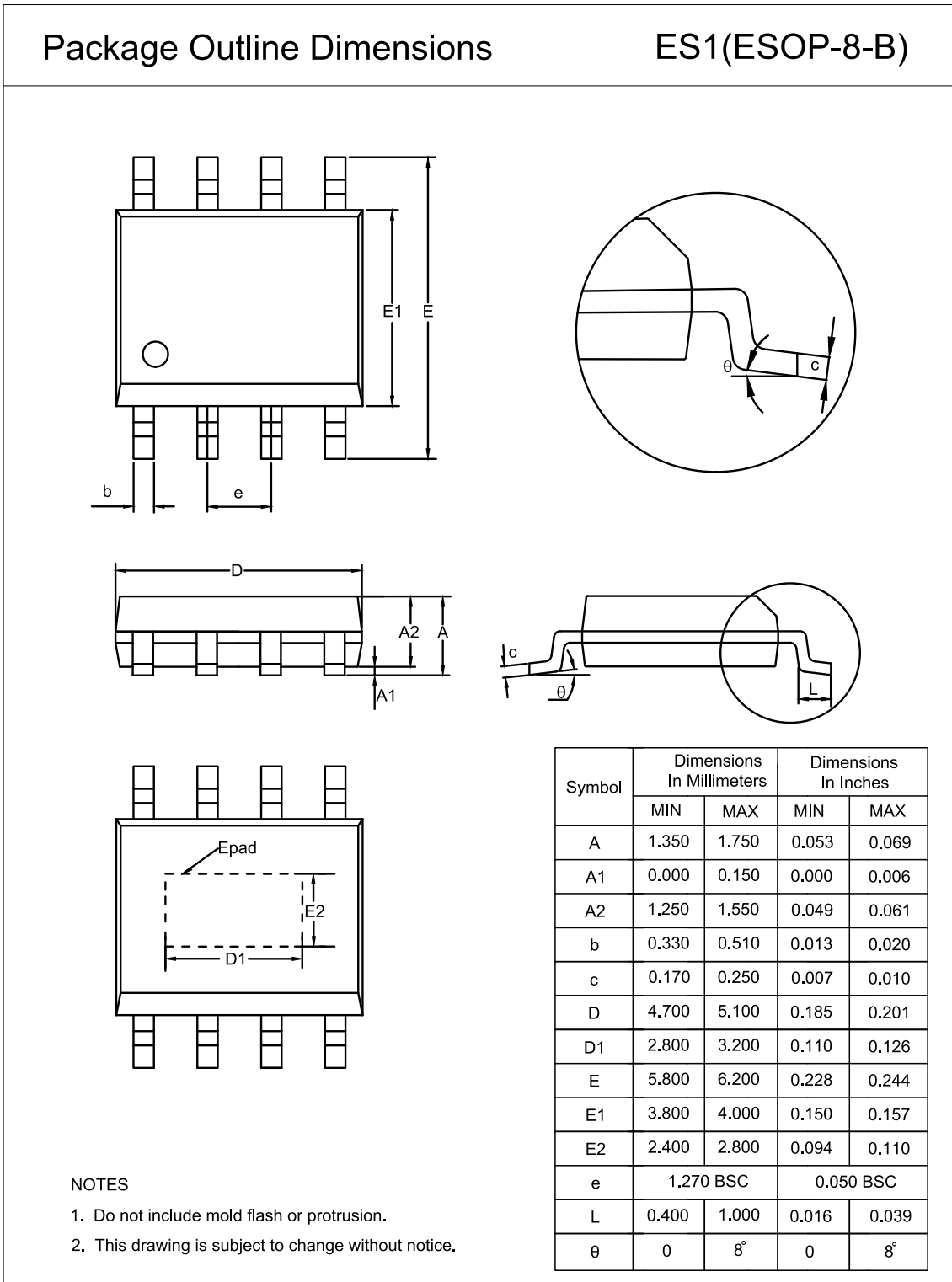
Package Outline Dimensions
ESOP8

20-V/300-mA Wide-input High-PSRR Ultra-low Noise LDO Regulator**Order Information**

Order Number	Operating Temperature Range	Package	Marking Information	MSL	Transport Media, Quantity	Eco Plan
TPL8032ADQ-ES1R-S	-40 to 125°C	ESOP8	LBA	MSL3	Tape and Reel, 4,000	Green

Green: 3PEAK defines "Green" to mean RoHS compatible and free of halogen substances.

IMPORTANT NOTICE AND DISCLAIMER

Copyright© 3PEAK 2012-2024. All rights reserved.

Trademarks. Any of the 思瑞浦 or 3PEAK trade names, trademarks, graphic marks, and domain names contained in this document /material are the property of 3PEAK. You may NOT reproduce, modify, publish, transmit or distribute any Trademark without the prior written consent of 3PEAK.

Performance Information. Performance tests or performance range contained in this document/material are either results of design simulation or actual tests conducted under designated testing environment. Any variation in testing environment or simulation environment, including but not limited to testing method, testing process or testing temperature, may affect actual performance of the product.

Disclaimer. 3PEAK provides technical and reliability data (including data sheets), design resources (including reference designs), application or other design recommendations, networking tools, security information and other resources "As Is". 3PEAK makes no warranty as to the absence of defects, and makes no warranties of any kind, express or implied, including without limitation, implied warranties as to merchantability, fitness for a particular purpose or non-infringement of any third-party's intellectual property rights. Unless otherwise specified in writing, products supplied by 3PEAK are not designed to be used in any life-threatening scenarios, including critical medical applications, automotive safety-critical systems, aviation, aerospace, or any situations where failure could result in bodily harm, loss of life, or significant property damage. 3PEAK disclaims all liability for any such unauthorized use.