

**Features**

- AEC-Q101 Qualified
- Ultra Low Leakage
- Ultra Low Capacitance
- Low Clamping Voltage
- Moisture Sensitivity Level 1
- Epoxy Meets UL 94 V-0 Flammability Rating
- Halogen Free. "Green" Device (Note 1)
- Lead Free Finish/RoHS Compliant ("P" Suffix Designates RoHS Compliant. See Ordering Information)

**Maximum Ratings**

IEC61000-4-2(ESD)	Air	±25KV
	Contact	±20KV
Peak Pulse Power (8/20µs)	PPK	90W
Peak Pulse Current (8/20µs)(Note 2)	I <sub>PP</sub>	3.5A
Operating Junction Temperature Range	T <sub>J</sub>	-55°C to +125°C
Storage Temperature Range	T <sub>STG</sub>	-55°C to +150°C

Note:  
 1. Halogen free "Green" products are defined as those which contain <900ppm bromine, <900ppm chlorine (<1500ppm total Br + Cl) and <1000ppm antimony compounds.  
 2. Non-repetitive current pulse 8/20 µs exponential decay waveform according to IEC61000-4-5.

**ESD  
Protection  
Device**

**DFN1006-2L**

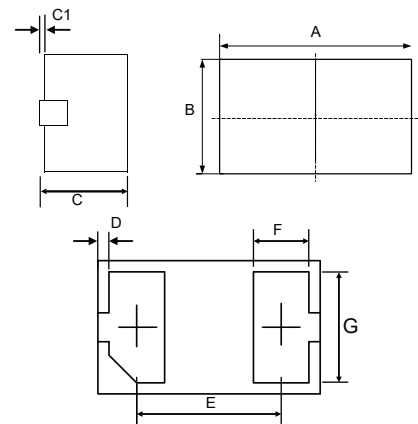

DIM	INCHES		MM		NOTE
	MIN	MAX	MIN	MAX	
A	0.037	0.041	0.95	1.05	
B	0.022	0.026	0.55	0.65	
C	0.016	0.022	0.40	0.55	
C1	-----	0.004	-----	0.10	
D	0.001	0.003	0.02	0.08	
E	0.026		0.65		TYP.
F	0.008	0.012	0.20	0.30	
G	0.018	0.022	0.45	0.55	

**Internal Structure**



**Marking Code**



**SUGGESTED SOLDER PAD LAYOUT**

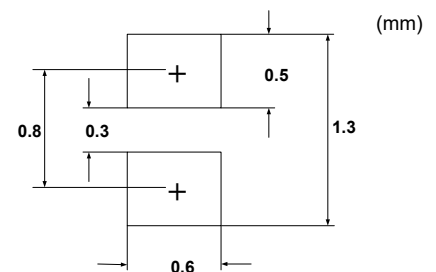

Symbol	Parameter
$I_{PP}$	Maximum Reverse Peak Pulse Current
$V_C$	Clamping Voltage @ $I_{PP}$
$V_{RWM}$	Working Peak Reverse Voltage
$I_R$	Maximum Reverse Leakage Current @ $V_{RWM}$
$V_{BR}$	Breakdown Voltage @ $I_T$
$I_T$	Test Current
C	Capacitance @ $V_R=0$ and $f = 1\text{MHz}$

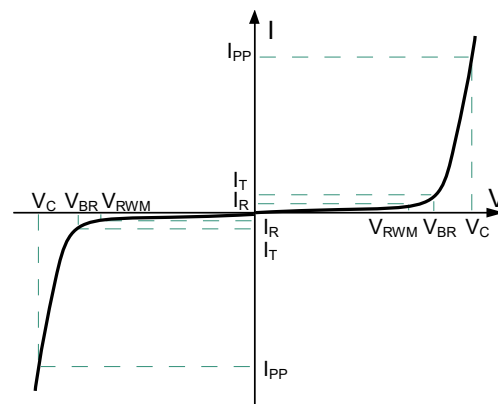

**Electrical Characteristics @ 25°C (Unless Otherwise Specified)**

Parameter	Symbol	Conditions	Min.	Typ.	Max.	Units
Reverse Working Voltage	$V_{RWM}$				8	V
Reverse Breakdown Voltage	$V_{BR}$	$I_T=1\text{mA}$	9.5		11.5	V
Reverse Leakage Current	$I_R$	$V_{RWM}=8\text{V}$			0.2	$\mu\text{A}$
Clamping Voltage <sup>Note1</sup>	$V_C$	$I_{PP}=1\text{A}$ , $t_p=8/20\mu\text{s}$			18	V
Clamping Voltage <sup>Note1</sup>	$V_C$	$I_{PP}=3.5\text{A}$ , $t_p=8/20\mu\text{s}$			26	V
Junction Capacitance	$C_J$	$V_R=0\text{V}$ , $f=1\text{MHz}$		0.3	0.5	pF
Dynamic Resistance <sup>Note2</sup>	$R_{DYN}$	TLP, $t_p=100\text{ns}$		1.65		$\Omega$

Note:

1. Non-repetitive current pulse 8/20 $\mu\text{s}$  exponential decay waveform according to IEC61000-4-5.
2. TLP parameter:  $Z_0=50\Omega$ ,  $t_p=100\text{ns}$ ,  $t_r=2\text{ns}$ , averaging window from 60ns to 80ns.  $R_{DYN}$  is calculated from 4A to 16A.

## Curve Characteristics

Fig. 1 - 8 X 20µs Pulse Waveform

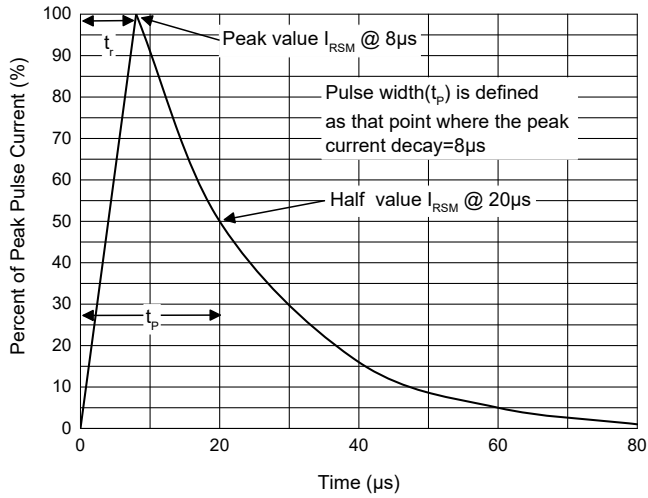

Fig. 2 - Non-Repetitive Peak Pulse Power

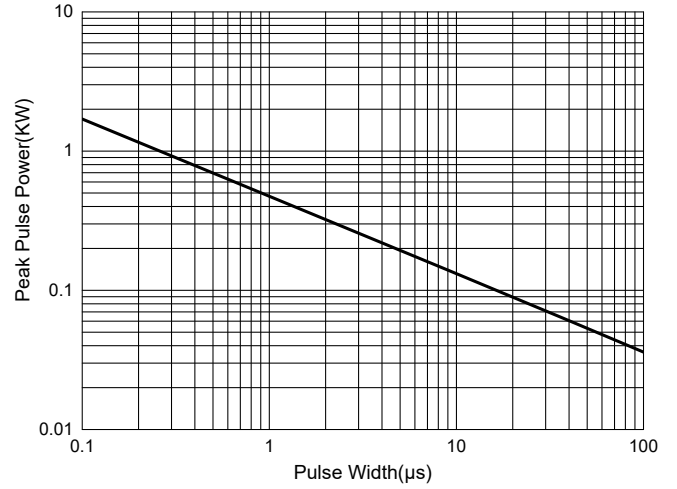

Fig. 3 - Capacitance Characteristics

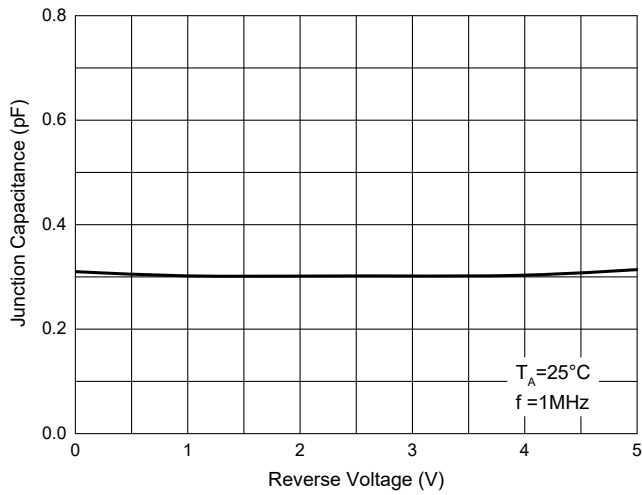

Fig. 4 - Clamping Voltage Characteristics

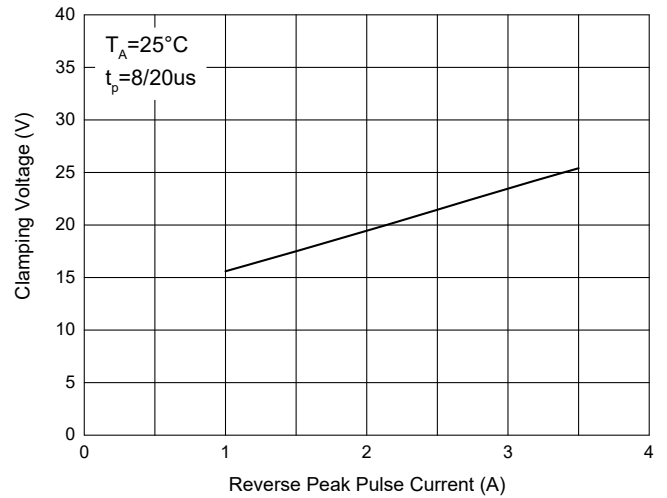

Fig. 5 - TLP Measurement

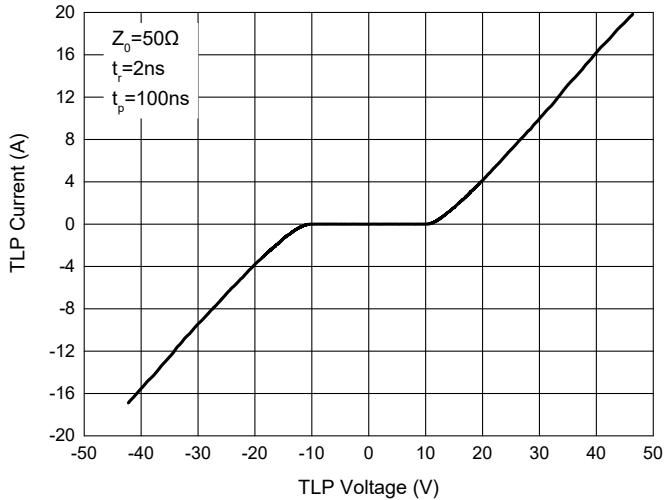
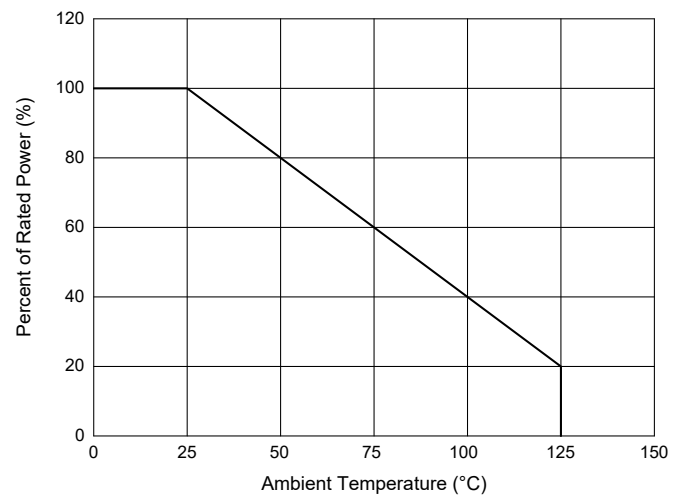

Fig. 6 - Pulse Derating Curve



## Ordering Information

Device	Packing
Part Number-TP	Tape&Reel: 10Kpcs/Reel

**\*\*\*IMPORTANT NOTICE\*\*\***

*Micro Commercial Components Corp.* reserves the right to make changes without further notice to any product herein to make corrections, modifications, enhancements, improvements, or other changes. *Micro Commercial Components Corp.* does not assume any liability arising out of the application or use of any product described herein; neither does it convey any license under its patent rights, nor the rights of others. The user of products in such applications shall assume all risks of such use and will agree to hold *Micro Commercial Components Corp.* and all the companies whose products are represented on our website, harmless against all damages. *Micro Commercial Components Corp.* products are sold subject to the general terms and conditions of commercial sale, as published at <https://www.mccsemi.com/Home/TermsAndConditions>.

**\*\*\*LIFE SUPPORT\*\*\***

MCC's products are not authorized for use as critical components in life support devices or systems without the express written approval of Micro Commercial Components Corporation.

**\*\*\*CUSTOMER AWARENESS\*\*\***

Counterfeiting of semiconductor parts is a growing problem in the industry. Micro Commercial Components (MCC) is taking strong measures to protect ourselves and our customers from the proliferation of counterfeit parts. MCC strongly encourages customers to purchase MCC parts either directly from MCC or from Authorized MCC Distributors who are listed by country on our web page cited below. Products customers buy either from MCC directly or from Authorized MCC Distributors are genuine parts, have full traceability, meet MCC's quality standards for handling and storage. **MCC will not provide any warranty coverage or other assistance for parts bought from Unauthorized Sources.** MCC is committed to combat this global problem and encourage our customers to do their part in stopping this practice by buying direct or from authorized distributors.