

ISL8126EVAL1Z

Evaluation Board

AN1713
Rev.0.00
December 23, 2011

Hardware Description

The ISL8126 integrates two voltage-mode synchronous buck PWM controllers. It can be used either for dual independent outputs or a 2-phase single-output regulator.

The ISL8126EVAL1Z evaluation board is used for performance demo of the 2-phase single-output application. This application note introduces the setup procedure and performance of the ISL8126EVAL1Z evaluation board.

TABLE 1. ELECTRICAL SPECIFICATIONS

PARAMETER	MIN	TYP	MAX	UNITS
V _{IN}	10	12	16	V
V _{OUT}	1.18	1.2	1.22	V
Rated Current		50		A
Switching Frequency		350		kHz
V _{OUT} Peak-to-Peak Ripple		16		mV _{P-P}

Recommended Equipment

- 0V to 22V power supply with at least 20A source current capability
- Two electronic loads capable of sinking current up to 30A
- Digital multimeters (DMMs)
- 100MHz quad-trace oscilloscope.

Quick Start

1. Ensure that the circuit is correctly connected to the supply and loads prior to applying any power.
2. Adjust the input supply to be 12V. Turn on the input power supply.
3. Verify the output voltage is 1.2V. If PGOOD is set high, the LED2 will be green. If PGOOD is set low, the LED2 will be red. TP4 is the test post to monitor PGOOD.

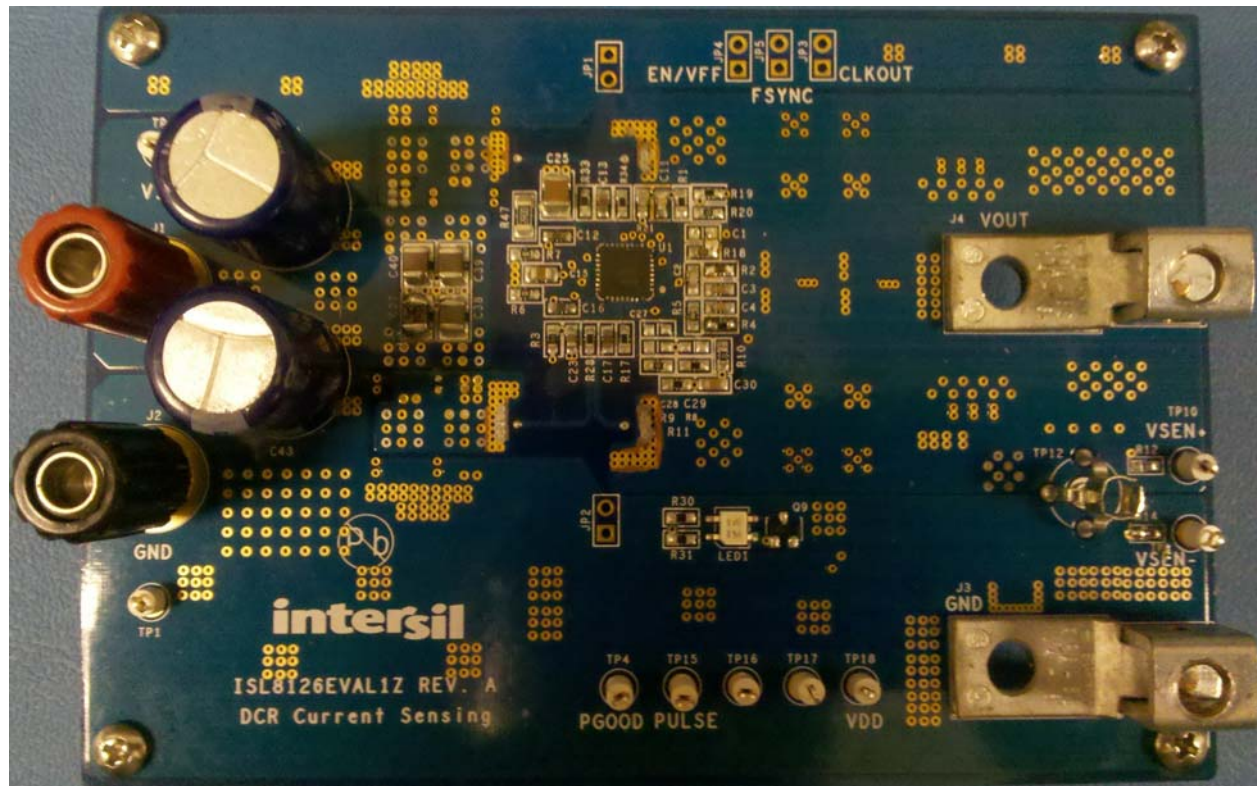

FIGURE 1. ISL8126EVAL1Z EVALUATION BOARD

Circuits Description

J1 and J2 are the input power terminals.

J3 and J4 are output lugs for load connections.

The input capacitors are used to handle the input current ripples.

Two upper and two lower Renesas LFPK MOSFETs are used for each phase.

320nH PULSE surface mount inductors are used for each phase. Under the 350kHz setup, the inductor current peak-to-peak ripple is 10A at 12V input and 1.2V output.

Six SANYO POSCAP 2R5TPF470M7L are used as output E-capacitors.

TP8 and TP10 are remote sense posts. These pins can be used to monitor and evaluate the system voltage regulations. If the user wants to use these test posts for remote sense, the R_{12} and R_{14} need to be changed to higher values, such as 10Ω. Also, the related voltage sense divider needs to be increased to a higher resistance, such as 1k.

TP12 is a test socket to hold the scope probe to check the output waveforms.

JP4 (not populated) is used to disable the part.

JP5 is for connection of inputs of clock signal for the part to be synchronized with.

JP3 is the CLKOUT pin output of ISL8126.

Programming the Input Voltage UVLO and its Hysteresis

By programming the voltage divider at the EN/FF pin connected to the input rail, the input UVLO and its hysteresis can be programmed. The ISL8126EVAL1Z has R_{19} 16.5k and R_1 1.82k; the IC will be disabled when input voltage drops below 8V and will restart until V_{IN} recovers to be above 9V.

Refer to equations on page 25 of the ISL8126 datasheet (FN7892) to program the UVLO falling threshold and hysteresis. The EN/FF1 and EN/FF2 pins are connected together in ISL8126EVAL1Z. The equations are re-stated here in Equations 1 and 2, where R_{UP} and R_{DOWN} are the upper and lower resistors of the voltage divider at EN/FF pin, V_{HYS} is the desired UVLO hysteresis and V_{FTH} is the desired UVLO falling threshold.

$$R_{UP} = \frac{V_{HYS}}{2 \cdot I_{HYS}} \quad \text{where } I_{HYS} = 30\mu\text{A} \quad (\text{EQ. 1})$$

$$R_{DOWN} = \frac{R_{UP} \cdot V_{ENREF}}{V_{FTH} - V_{ENREF}} \quad \text{where } V_{ENREF} = 0.8\text{V} \quad (\text{EQ. 2})$$

NOTE: The ISL8126 EN/FF pin is a triple function pin and the voltages applied to the EN/FF pins are also fed to adjust the amplitude of each channel's individual sawtooth.

Evaluating the Other Output Voltage

The ISL8126EVAL1Z kit output is preset to 1.2V/50A. V_{OUT} can also be adjusted between 0.6V to 2V by changing the value of R_{11} and R_8 for V_{OUT} , as given by Equation 3.

$$R_{11} = [(V_{OUT}/V_{REF}) - 1] \cdot R_8 \quad \text{where } V_{REF} = 0.6\text{V} \quad (\text{EQ. 3})$$

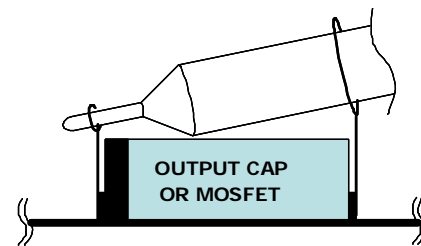

FIGURE 3. PROPER PROBE SET-UP TO MEASURE OUTPUT RIPPLE AND PHASE NODE RINGING

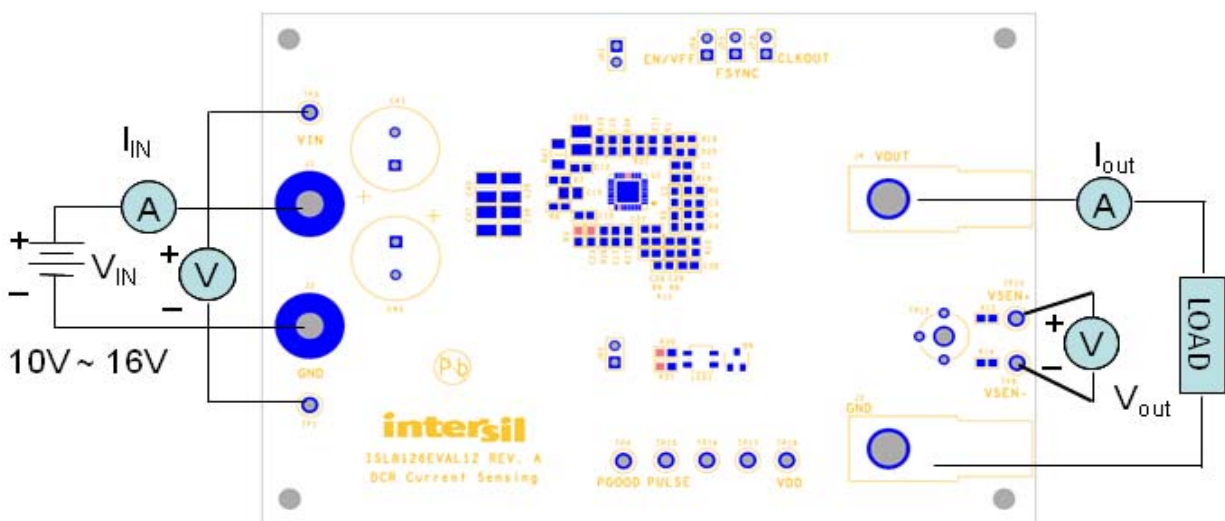

FIGURE 2. PROPER TEST SET-UP

Load Transient Circuit Set-up

1. Install the load transient circuit as indicated in the schematic. Refer to Figure 4 for detail.
2. R_{50} , R_{51} are resistors for charging/discharging the MOSFET gates. Their resistance determines the slew-rate of the load step. The slew-rate in this particular setup is $3A/\mu s$.
3. When Q_{10} is fully turned on, its $r_{DS(ON)}$ in series with R_{48} sets the current step amplitude. For accurate measurement, please use 5% tolerance sensing resistor or better. R_{48} is also

the current sensing resistor to monitor the load step. The resistance of the sensing resistor sets the current scale on the oscilloscope. The amplitude of the current step in this particular setup is 48A.

4. Apply 5V bias voltage between TP18 and TP17 (GND). Apply 3V pulse square waveform between TP15 and TP16 (GND). The duty cycle of the pulse waveform should be small (<5%) to limit thermal stress on R_{48} and Q_{10} .
5. Monitor overshoot and undershoot at corresponding output.

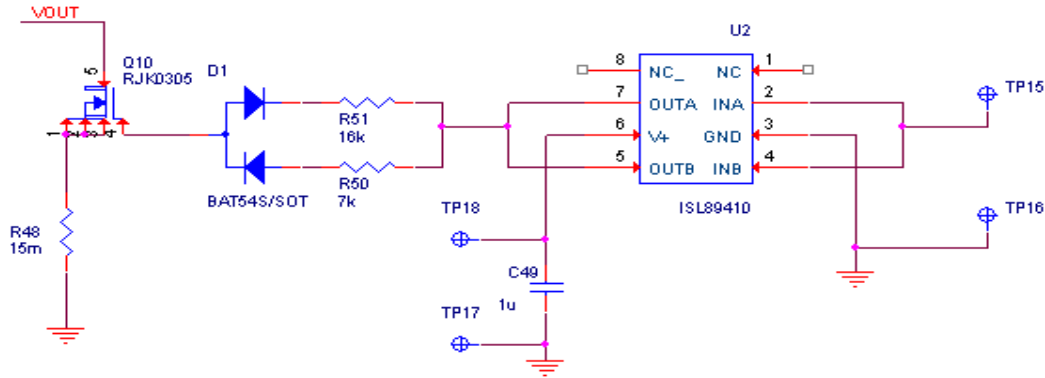

FIGURE 4. LOAD TRANSIENT CIRCUIT

Typical Evaluation Board Performance Curves $V_{IN} = 12V$, Unless Otherwise Noted.

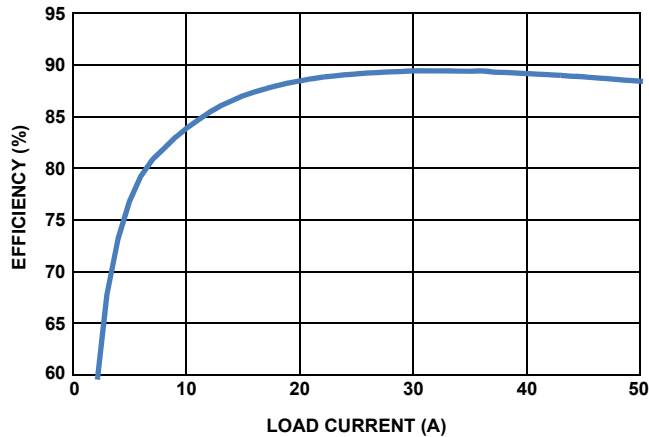

FIGURE 5. EFFICIENCY vs LOAD ($V_O = 1.2V$)

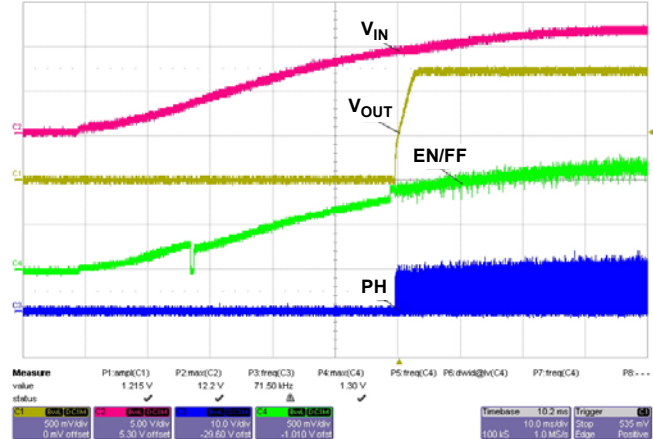

FIGURE 6. POWER-UP UNDER 50A LOAD

Typical Evaluation Board Performance Curves $V_{IN} = 12V$, Unless Otherwise Noted. (Continued)

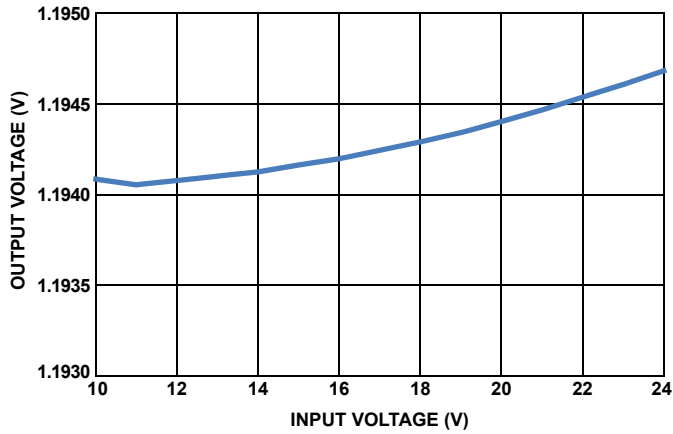

FIGURE 7. LINE REGULATION

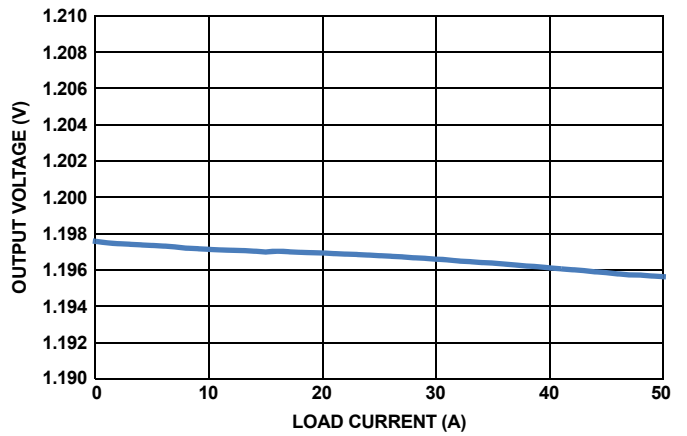

FIGURE 8. LOAD REGULATION

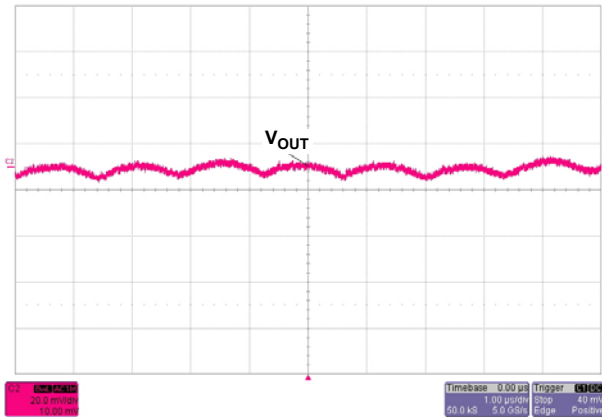

FIGURE 9. OUTPUT RIPPLE AT 0A LOAD

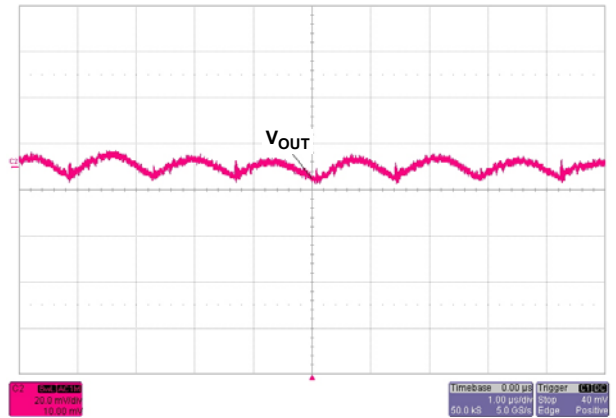

FIGURE 10. OUTPUT RIPPLE AT 50A LOAD

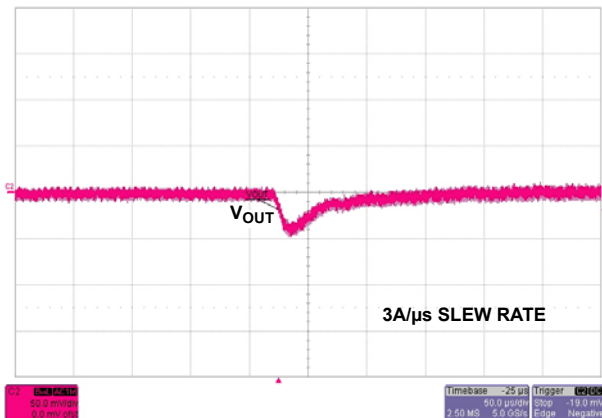

FIGURE 11. LOAD TRANSIENT (0A TO 48A STEP)

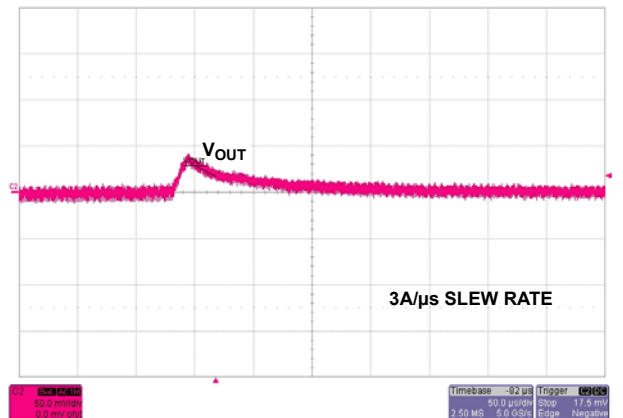

FIGURE 12. LOAD TRANSIENT (48A TO 0A STEP)

Schematic

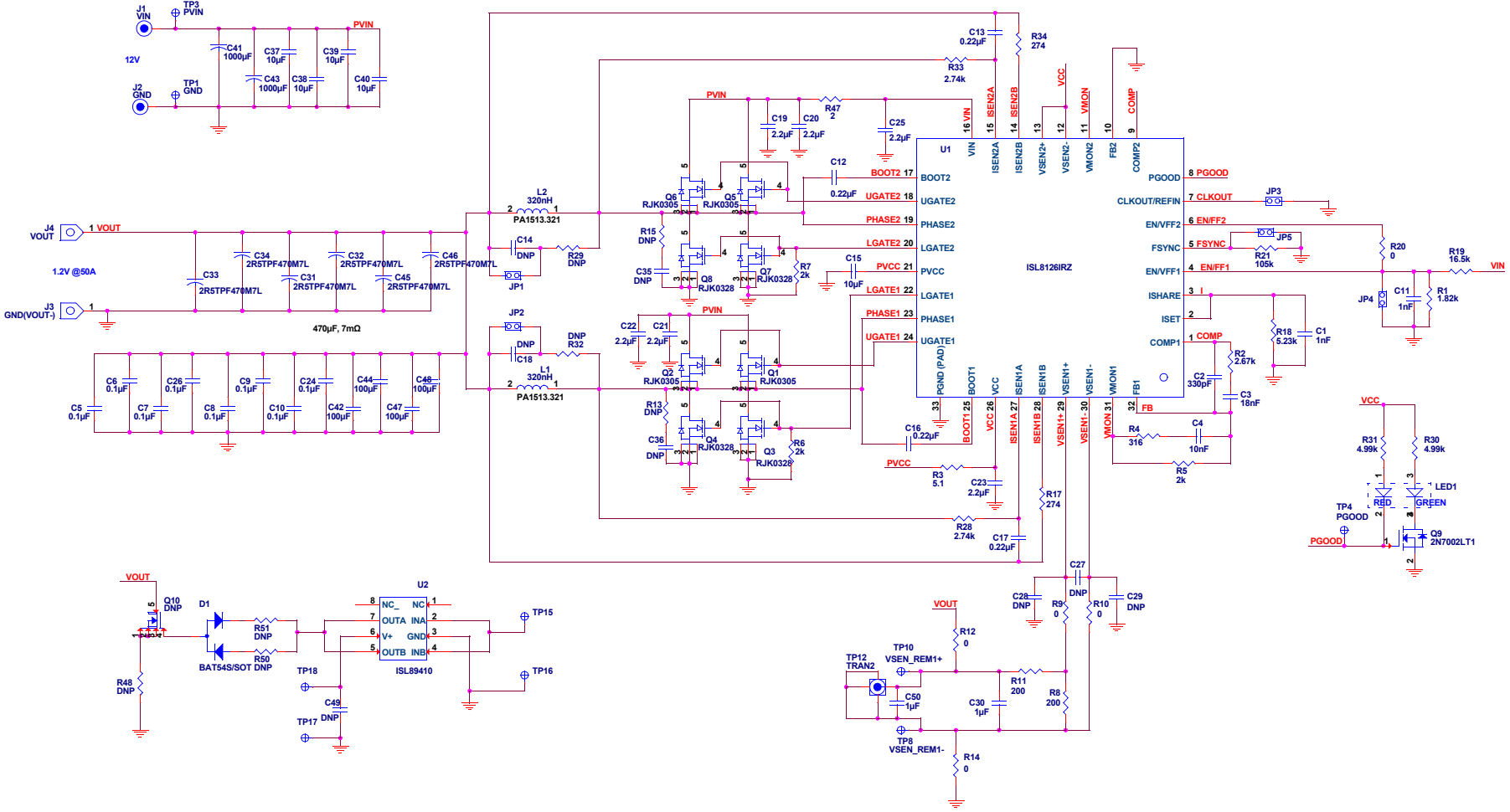

TABLE 2. BILL OF MATERIALS

ITEM	QTY	PART REFERENCE	VALUE	DESCRIPTION	PART #	MANUFACTURER
ESSENTIAL COMPONENTS						
1	2	C1, C11	1nF	CAP Ceramic Y7R, 50V, SMD, 0603		Generic
2	1	C4	0.01μF	CAP Ceramic Y5R, 50V, SMD, 0603		Generic
3	8	C5, C6, C7, C8, C9, C10, C24, C26	0.1μF	CAP Ceramic X7R, 50V, SMD, 0603		Generic
4	1	C3	18nF	CAP Ceramic X7R, 50V, SMD, 0603		Generic
5	4	C12, C13, C16, C17	0.22μF	CAP Ceramic X7R, 50V, SMD, 0603		Generic
6	1	C23	2.2μF	CAP Ceramic X5R, 25V, SMD, 0603		Generic
7	1	C2	330pF	CAP Ceramic X5R, 25V, SMD, 0603		Generic
8	2	C30, C50	1μF	CAP Ceramic X5R, 25V, SMD, 0805		Generic
9	1	C15	10μF	CAP Ceramic X5R, 50V, SMD, 0805		Generic
10	4	C37, C38, C39, C40	10μF	CAP Ceramic X5R, 50V, SMD, 1210		Generic
11	4	C42, C44, C47, C4	100μF	CAP Ceramic X5R, 6.3V, SMD, 1210		Generic
12	5	C19, C20, C21, C22, C25	2.2μF	CAP Ceramic X7R, 50V, SMD, 1210		Generic
13	6	C31, C32, C33, C34, C45, C46	470μF	POSCAP, 6.3V, SMD, D3L	2R5TPF470M7L	Sanyo
14	2	C41, C43	1000μF	Alum. Elec. CAP 35V	ECA-1VM102B	Panasonic
15	2	L1, L2	320nH	Inductor	PA1513.321NLT	PULSE
16	4	Q1, Q2, Q5, Q6		TRANSISTOR, N-CHANNEL, LPAK, 30V	RJK0305DPB	RENESAS TECHNOLOGY
17	4	Q3, Q4, Q7, Q8		TRANSISTOR, N-CHANNEL, LPAK, 30V	RJK0328DPB	RENESAS TECHNOLOGY
18	1	R3	5.1Ω	RESISTOR, SMD, 0603, 10%		Generic
19	5	R9, R10, R12, R14, R20	0Ω	RESISTOR, SMD, 0603, 10%		Generic
20	1	R21	105kΩ	RESISTOR, SMD, 0603, 1%		Generic
21	1	R19	16.5kΩ	RESISTOR, SMD, 0603, 1%		Generic
22	1	R1	1.82kΩ	RESISTOR, SMD, 0603, 1%		Generic
232	2	R8, R11	200Ω	RESISTOR, SMD, 0603, 1%		Generic
24	3	R5, R6, R7	2kΩ	RESISTOR, SMD, 0603, 1%		Generic
25	1	R2	2.67kΩ	RESISTOR, SMD, 0603, 1%		Generic
26	2	R17, R34	274Ω	RESISTOR, SMD, 0603, 1%		Generic
27	2	R28, R33	2.74kΩ	RESISTOR, SMD, 0603, 1%		Generic
28	1	R4	316Ω	RESISTOR, SMD, 0603, 1%		Generic
29	1	R18	5.23kΩ	RESISTOR, SMD, 0603, 1%		Generic
30	1	R47	2Ω	RESISTOR, SMD, 1206, 1%		Generic
31	1	U1		IC-DUAL PHASE PWM CONTROLLER, 32P, QFN, 5x5, ROHS	ISL8126IRZ	INTERSIL
OPTIONAL COMPONENTS OR RESISTOR JUMPERS						
40	1	LED1		LED, SMD, 3x2.5mm, 4P, RED/GREEN	SSL-LXA3025IGC-TR	LUMEX
41	1	Q9	DNP	TRANSISTOR, SOT23, 60V	2N7002LT1G	ON SEMICONDUCTOR
42	2	R30, R31	4.99kΩ	RESISTOR, SMD, 0603, 1%		Generic
42		U2		HIGH SPEED POWER MOSFET DRIVER	ISL89410IPZ	Intersil
43		C49	2.2μF	CAP Ceramic X5R, 25V, SMD, 0603		Generic
44		R51	16kΩ	RESISTOR, SMD, 0603, 1%		Generic

TABLE 2. BILL OF MATERIALS (Continued)

ITEM	QTY	PART REFERENCE	VALUE	DESCRIPTION	PART #	MANUFACTURER
45		R50	7.06k Ω	RESISTOR, SMD, 0603, 1%		Generic
46		D1		DUAL SCHOTTKY DIODE, SOT-23	BAT54S	Generic
47		Q10		TRANSISTOR, N-CHANNEL, LFPAK, 30V	RJK0305DPB	RENESAS TECHNOLOGY
48		R48	15m Ω	RESISTOR, SMD, 2512, 1W		Generic
EVALUATION BOARD HARDWARE						
46	1	J1		BINDING POST, RED	111-0702-001	JOHNSON COMPONENTS
47	1	J2		BINDING POST, BLACK	111-0703-001	JOHNSON COMPONENTS
48	1	J3, J4		CABLE TERMINAL, 6 -14AWG, LUG&SCREW	KPA8CTP	BERG/FCI
48	1	TP1, TP3, TP4, TP8, TP10, TP15, TP16, TP17, TP18		TEST POINT	5002	Keystone

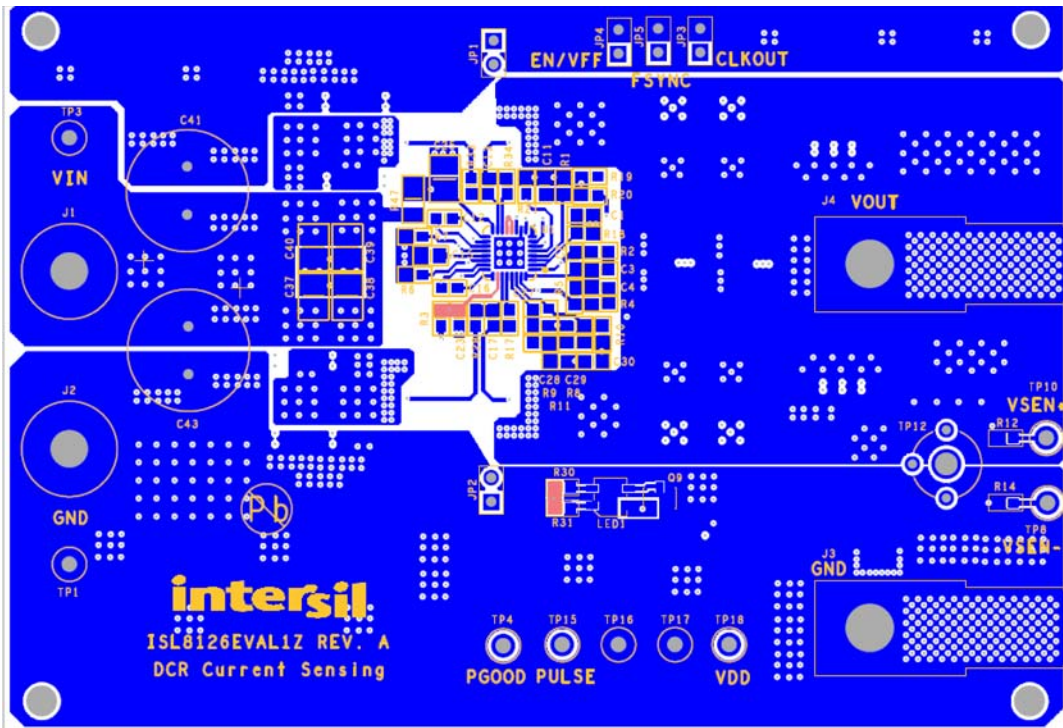

FIGURE 13. ISL8126EVAL1Z EVALUATION BOARD TOP LAYER

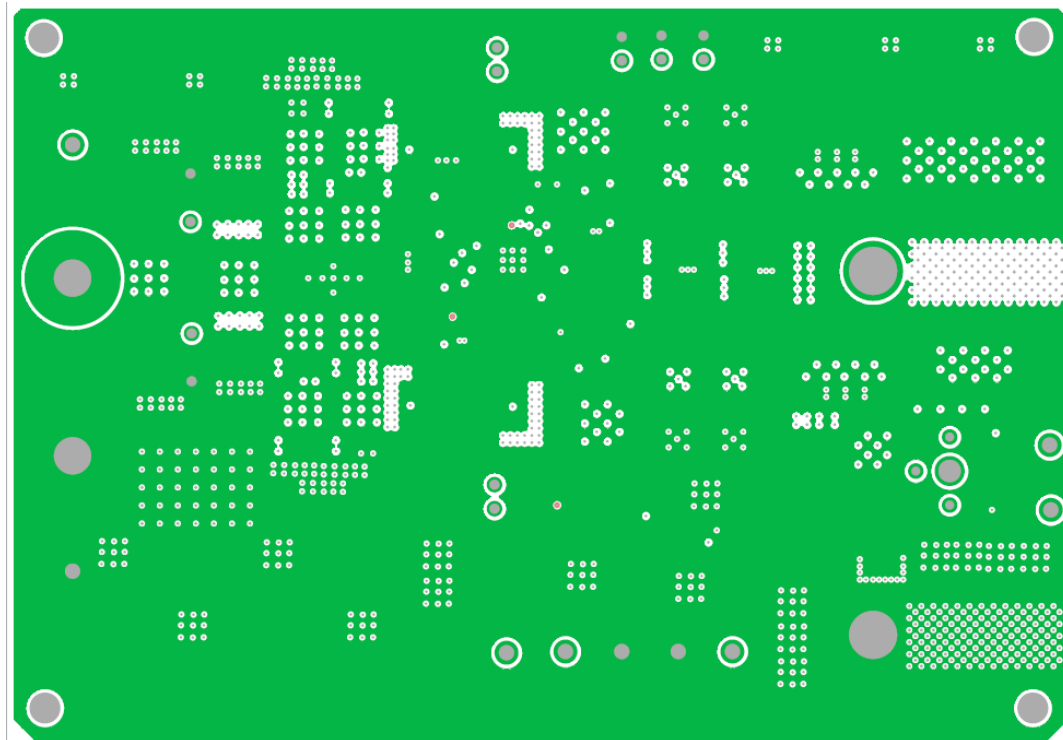

FIGURE 14. ISL8126EVAL1Z EVALUATION BOARD 2ND LAYER

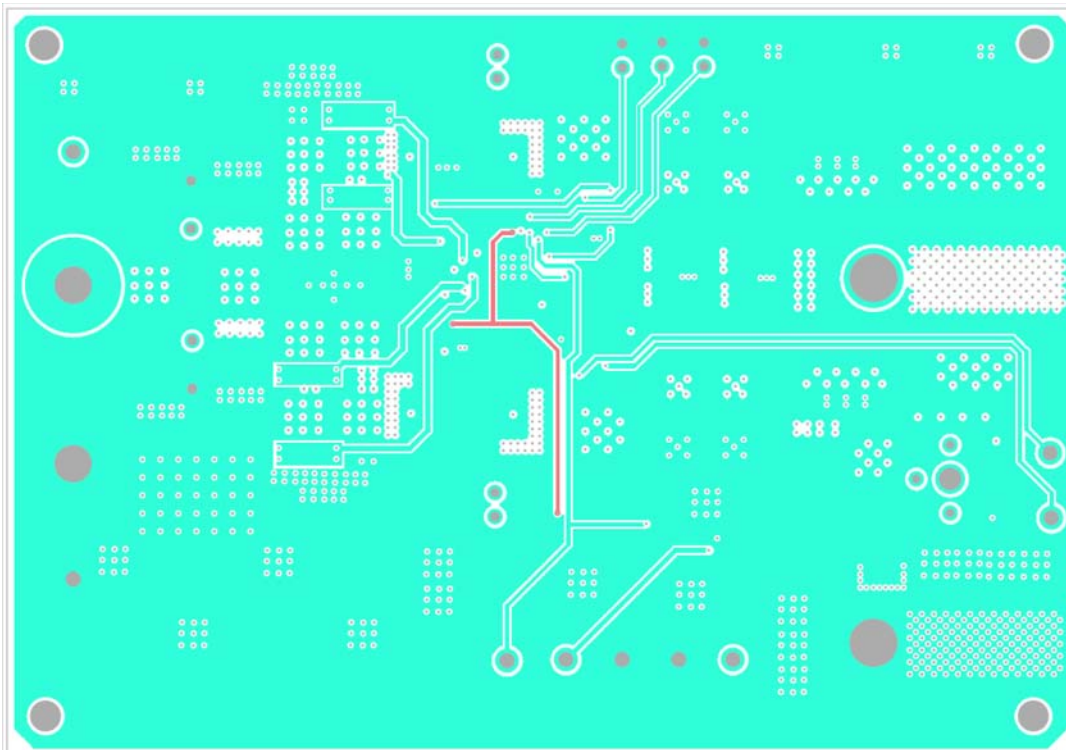

FIGURE 15. ISL8126EVAL1Z EVALUATION BOARD 3RD LAYER

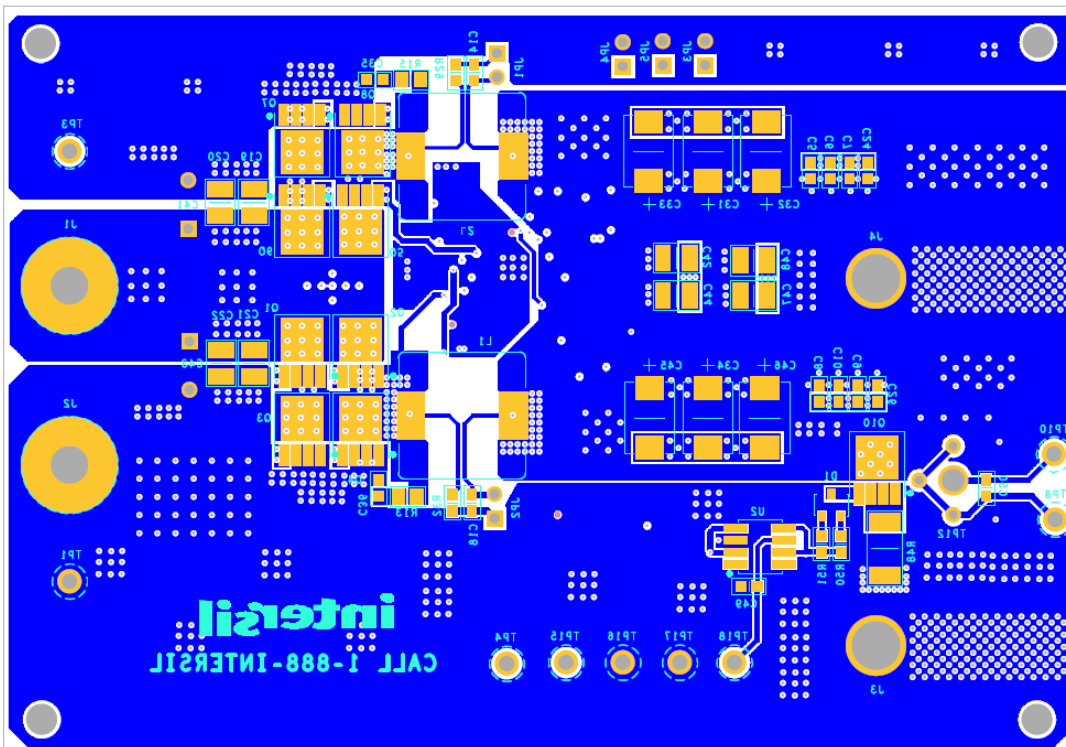

FIGURE 16. ISL8126EVAL1Z EVALUATION BOARD BOTTOM LAYER

Notice

1. Descriptions of circuits, software and other related information in this document are provided only to illustrate the operation of semiconductor products and application examples. You are fully responsible for the incorporation or any other use of the circuits, software, and information in the design of your product or system. Renesas Electronics disclaims any and all liability for any losses and damages incurred by you or third parties arising from the use of these circuits, software, or information.
2. Renesas Electronics hereby expressly disclaims any warranties against and liability for infringement or any other claims involving patents, copyrights, or other intellectual property rights of third parties, by or arising from the use of Renesas Electronics products or technical information described in this document, including but not limited to, the product data, drawings, charts, programs, algorithms, and application examples.
3. No license, express, implied or otherwise, is granted hereby under any patents, copyrights or other intellectual property rights of Renesas Electronics or others.
4. You shall not alter, modify, copy, or reverse engineer any Renesas Electronics product, whether in whole or in part. Renesas Electronics disclaims any and all liability for any losses or damages incurred by you or third parties arising from such alteration, modification, copying or reverse engineering.
5. Renesas Electronics products are classified according to the following two quality grades: "Standard" and "High Quality". The intended applications for each Renesas Electronics product depends on the product's quality grade, as indicated below.
"Standard": Computers; office equipment; communications equipment; test and measurement equipment; audio and visual equipment; home electronic appliances; machine tools; personal electronic equipment; industrial robots; etc.
"High Quality": Transportation equipment (automobiles, trains, ships, etc.); traffic control (traffic lights); large-scale communication equipment; key financial terminal systems; safety control equipment; etc.
Unless expressly designated as a high reliability product or a product for harsh environments in a Renesas Electronics data sheet or other Renesas Electronics document, Renesas Electronics products are not intended or authorized for use in products or systems that may pose a direct threat to human life or bodily injury (artificial life support devices or systems; surgical implantations; etc.), or may cause serious property damage (space system; undersea repeaters; nuclear power control systems; aircraft control systems; key plant systems; military equipment; etc.). Renesas Electronics disclaims any and all liability for any damages or losses incurred by you or any third parties arising from the use of any Renesas Electronics product that is inconsistent with any Renesas Electronics data sheet, user's manual or other Renesas Electronics document.
6. When using Renesas Electronics products, refer to the latest product information (data sheets, user's manuals, application notes, "General Notes for Handling and Using Semiconductor Devices" in the reliability handbook, etc.), and ensure that usage conditions are within the ranges specified by Renesas Electronics with respect to maximum ratings, operating power supply voltage range, heat dissipation characteristics, installation, etc. Renesas Electronics disclaims any and all liability for any malfunctions, failure or accident arising out of the use of Renesas Electronics products outside of such specified ranges.
7. Although Renesas Electronics endeavors to improve the quality and reliability of Renesas Electronics products, semiconductor products have specific characteristics, such as the occurrence of failure at a certain rate and malfunctions under certain use conditions. Unless designated as a high reliability product or a product for harsh environments in a Renesas Electronics data sheet or other Renesas Electronics document, Renesas Electronics products are not subject to radiation resistance design. You are responsible for implementing safety measures to guard against the possibility of bodily injury, injury or damage caused by fire, and/or danger to the public in the event of a failure or malfunction of Renesas Electronics products, such as safety design for hardware and software, including but not limited to redundancy, fire control and malfunction prevention, appropriate treatment for aging degradation or any other appropriate measures. Because the evaluation of microcomputer software alone is very difficult and impractical, you are responsible for evaluating the safety of the final products or systems manufactured by you.
8. Please contact a Renesas Electronics sales office for details as to environmental matters such as the environmental compatibility of each Renesas Electronics product. You are responsible for carefully and sufficiently investigating applicable laws and regulations that regulate the inclusion or use of controlled substances, including without limitation, the EU RoHS Directive, and using Renesas Electronics products in compliance with all these applicable laws and regulations. Renesas Electronics disclaims any and all liability for damages or losses occurring as a result of your noncompliance with applicable laws and regulations.
9. Renesas Electronics products and technologies shall not be used for or incorporated into any products or systems whose manufacture, use, or sale is prohibited under any applicable domestic or foreign laws or regulations. You shall comply with any applicable export control laws and regulations promulgated and administered by the governments of any countries asserting jurisdiction over the parties or transactions.
10. It is the responsibility of the buyer or distributor of Renesas Electronics products, or any other party who distributes, disposes of, or otherwise sells or transfers the product to a third party, to notify such third party in advance of the contents and conditions set forth in this document.
11. This document shall not be reprinted, reproduced or duplicated in any form, in whole or in part, without prior written consent of Renesas Electronics.
12. Please contact a Renesas Electronics sales office if you have any questions regarding the information contained in this document or Renesas Electronics products.
(Note 1) "Renesas Electronics" as used in this document means Renesas Electronics Corporation and also includes its directly or indirectly controlled subsidiaries.
(Note 2) "Renesas Electronics product(s)" means any product developed or manufactured by or for Renesas Electronics.

(Rev.4.0-1 November 2017)



SALES OFFICES

Renesas Electronics Corporation

<http://www.renesas.com>

Refer to "<http://www.renesas.com/>" for the latest and detailed information.

Renesas Electronics America Inc.
1001 Murphy Ranch Road, Milpitas, CA 95035, U.S.A.
Tel: +1-408-432-8888, Fax: +1-408-434-5351

Renesas Electronics Canada Limited
9251 Yonge Street, Suite 8309 Richmond Hill, Ontario Canada L4C 9T3
Tel: +1-905-237-2004

Renesas Electronics Europe Limited
Dukes Meadow, Millboard Road, Bourne End, Buckinghamshire, SL8 5FH, U.K.
Tel: +44-1628-651-700, Fax: +44-1628-651-804

Renesas Electronics Europe GmbH
Arcadiastrasse 10, 40472 Düsseldorf, Germany
Tel: +49-211-6503-0, Fax: +49-211-6503-1327

Renesas Electronics (China) Co., Ltd.
Room 1709 Quantum Plaza, No.27 ZhichunLu, Haidian District, Beijing, 100191 P. R. China
Tel: +86-10-8235-1155, Fax: +86-10-8235-7679

Renesas Electronics (Shanghai) Co., Ltd.
Unit 301, Tower A, Central Towers, 555 Langao Road, Putuo District, Shanghai, 200333 P. R. China
Tel: +86-21-2226-0888, Fax: +86-21-2226-0999

Renesas Electronics Hong Kong Limited
Unit 1601-1611, 16/F., Tower 2, Grand Century Place, 193 Prince Edward Road West, Mongkok, Kowloon, Hong Kong
Tel: +852-2265-6688, Fax: +852-2886-9022

Renesas Electronics Taiwan Co., Ltd.
13F, No. 363, Fu Shing North Road, Taipei 10543, Taiwan
Tel: +886-2-8175-9600, Fax: +886-2-8175-9670

Renesas Electronics Singapore Pte. Ltd.
80 Bendemeer Road, Unit #06-02 Hyflux Innovation Centre, Singapore 339949
Tel: +65-6213-0200, Fax: +65-6213-0300

Renesas Electronics Malaysia Sdn.Bhd.
Unit 1207, Block B, Menara Amcorp, Amcorp Trade Centre, No. 18, Jln Persiaran Barat, 46050 Petaling Jaya, Selangor Darul Ehsan, Malaysia
Tel: +60-3-7955-9390, Fax: +60-3-7955-9510

Renesas Electronics India Pvt. Ltd.
No.777C, 100 Feet Road, HAL 2nd Stage, Indiranagar, Bangalore 560 038, India
Tel: +91-80-67208700, Fax: +91-80-67208777

Renesas Electronics Korea Co., Ltd.
17F, KAMCO Yangjae Tower, 262, Gangnam-daero, Gangnam-gu, Seoul, 06265 Korea
Tel: +82-2-558-3737, Fax: +82-2-558-5338