

### Features:

- 1350V Field Stop Trench Technology
- High Speed Switching
- Low Conduction Loss
- Positive Temperature Coefficient
- Easy Parallel Operation
- RoHS Compliant
- JEDEC Qualification

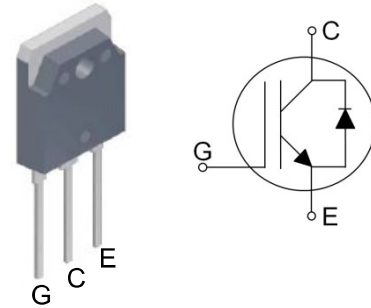

### Applications :

Induction Heating, Soft switching application

Device	Package	Marking	Remark
GPA030A135MN-FDR	TO-3PN	GPA030A135MN-FDR	RoHS

### Absolute Maximum Ratings

Parameter	Symbol	Value	Unit
Collector-Emitter Voltage	$V_{CES}$	1350	V
Gate-Emitter Voltage	$V_{GES}$	$\pm 20$	V
Continuous Collector Current	$I_c$	$T_C = 25\text{ }^\circ\text{C}$	60
		$T_C = 100\text{ }^\circ\text{C}$	30
Pulsed Collector Current (Note 1)	$I_{CM}$	90	A
Diode Continuous Forward Current	$I_F$	30	A
Power Dissipation	$P_D$	$T_C = 25\text{ }^\circ\text{C}$	329
		$T_C = 100\text{ }^\circ\text{C}$	132
Operating Junction Temperature	$T_J$	-55 ~ 150	$^\circ\text{C}$
Storage Temperature Range	$T_{STG}$	-55 ~ 150	$^\circ\text{C}$
Maximum lead temperature for soldering purposes, 1/8" from case for 5 seconds	$T_L$	300	$^\circ\text{C}$

Notes :

(1) Repetitive rating : Pulse width limited by maximum junction temperature

### Thermal Characteristics

Parameter	Symbol	Value	Unit
Maximum Thermal resistance, Junction-to-Case	$R_{\theta JC}$ (IGBT)	0.38	$^\circ\text{C}/\text{W}$
Maximum Thermal resistance, Junction-to-Case	$R_{\theta JC}$ (DIODE)	2.1	$^\circ\text{C}/\text{W}$
Maximum Thermal resistance, Junction-to-Ambient	$R_{\theta JA}$	40	$^\circ\text{C}/\text{W}$

**Electrical Characteristics of the IGBT**  $T_C=25^\circ\text{C}$ , unless otherwise noted

Parameter	Symbol	Test condition	Min.	Typ.	Max.	Unit
<b>OFF</b>						
Collector – Emitter Breakdown Voltage	$BV_{CES}$	$V_{GE} = 0V, I_C = 1mA$	1350	--	--	V
Zero Gate Voltage Collector Current	$I_{CES}$	$V_{CE} = 1350V, V_{GE} = 0V$	--	--	1	mA
Gate – Emitter Leakage Current	$I_{GES}$	$V_{CE} = 0V, V_{GE} = \pm 20V$	--	--	$\pm 250$	nA
<b>ON</b>						
Gate – Emitter Threshold Voltage	$V_{GE(TH)}$	$V_{GE} = V_{CE}, I_C = 30mA$	4.5	6.0	7.5	V
Collector – Emitter Saturation Voltage	$V_{CE(SAT)}$	$V_{GE} = 15V, I_C = 30A, T_C = 25^\circ\text{C}$	--	1.9	2.4	V
		$V_{GE} = 15V, I_C = 30A, T_C = 125^\circ\text{C}$	--	2.2	--	V
<b>DYNAMIC</b>						
Input Capacitance	$C_{IES}$	$V_{CE} = 30V,$ $V_{GE} = 0V$ $f = 1MHz$	--	3570	--	pF
Output Capacitance	$C_{OES}$		--	85	--	pF
Reverse Transfer Capacitance	$C_{RES}$		--	55	--	pF
<b>SWITCHING</b> (Note 2)						
Turn-On Delay Time	$t_{d(on)}$	$V_{CC} = 600V, I_C = 30A$ $R_G = 5\Omega, V_{GE} = 15V$ Inductive Load, $T_C = 25^\circ\text{C}$	--	30	--	ns
Rise Time	$t_r$		--	35	--	ns
Turn-Off Delay Time	$t_{d(off)}$		--	145	--	ns
Fall Time	$t_f$		--	115	172	ns
Turn-On Switching Loss	$E_{ON}$		--	4.4	6.6	mJ
Turn-Off Switching Loss	$E_{OFF}$		--	1.18	1.77	mJ
Total Switching Loss	$E_{TS}$		--	5.56	8.37	mJ
Turn-On Delay Time	$t_{d(on)}$	$V_{CC} = 600V, I_C = 30A$ $R_G = 5\Omega, V_{GE} = 15V$ Inductive Load, $T_C = 125^\circ\text{C}$	--	30	--	ns
Rise Time	$t_r$		--	35	--	ns
Turn-Off Delay Time	$t_{d(off)}$		--	160	--	ns
Fall Time	$t_f$		--	230	--	ns
Turn-On Switching Loss	$E_{ON}$		--	4.48	6.72	mJ
Turn-Off Switching Loss	$E_{OFF}$		--	2.3	3.45	mJ
Total Switching Loss	$E_{TS}$		--	6.78	10.17	mJ
Total Gate Charge	$Q_g$	$V_{CC} = 600V, I_C = 30A$ $V_{GE} = 15V$	--	200	300	nC
Gate-Emitter Charge	$Q_{ge}$		--	25	37	nC
Gate-Collector Charge	$Q_{gc}$		--	95	142	nC

Notes :

(2) Not subject to production test – verified by design/characterization

**Electrical Characteristics of the DIODE  $T_C=25^{\circ}\text{C}$ , unless otherwise noted**

Parameter	Symbol	Test condition	Min.	Typ.	Max.	Unit	
Diode Forward Voltage	$V_{FM}$	$I_F = 30\text{A}$	$T_C = 25^{\circ}\text{C}$	--	2.25	2.75	V
			$T_C = 125^{\circ}\text{C}$	--	2.53	--	
Reverse Recovery Time	$t_{rr}$	$I_F = 30\text{A},$ $di/dt = 200\text{A}/\mu\text{s}$	$T_C = 25^{\circ}\text{C}$	--	300	450	ns
			$T_C = 125^{\circ}\text{C}$	--	360	--	
Reverse Recovery Current	$I_{rr}$		$T_C = 25^{\circ}\text{C}$	--	30	45	A
			$T_C = 125^{\circ}\text{C}$	--	34	--	
Reverse Recovery Charge	$Q_{rr}$		$T_C = 25^{\circ}\text{C}$	--	4400	--	nC
			$T_C = 125^{\circ}\text{C}$	--	6120	--	

## IGBT Characteristics

Fig. 1 Output characteristics

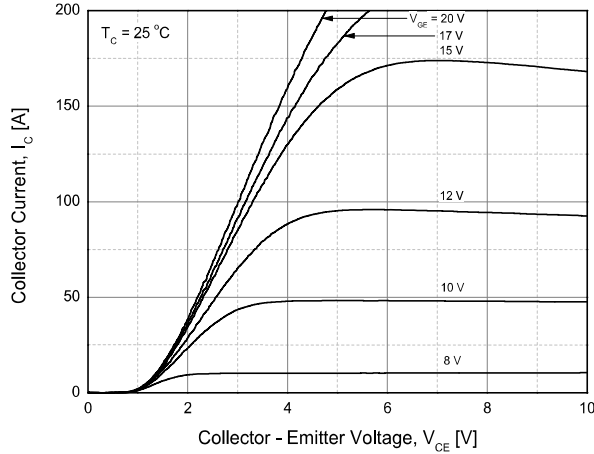

Fig. 2 Saturation voltage characteristics

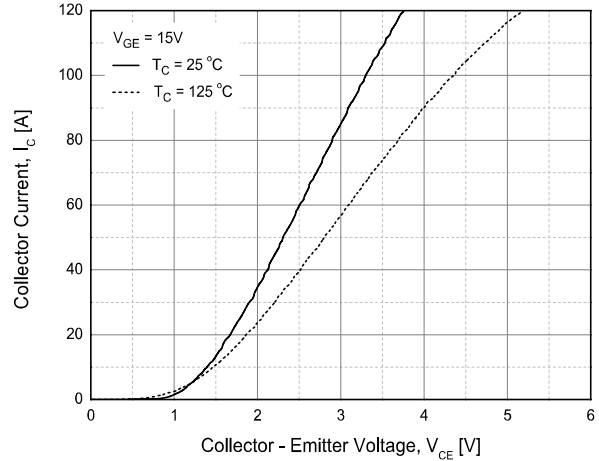

Fig. 3 Saturation voltage vs. collector current

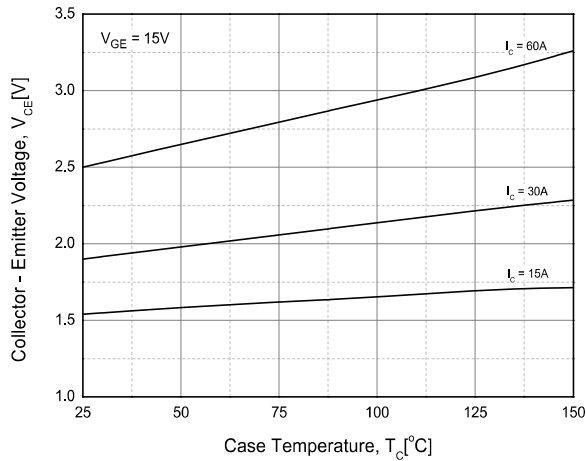

Fig. 4 Saturation voltage vs. gate bias

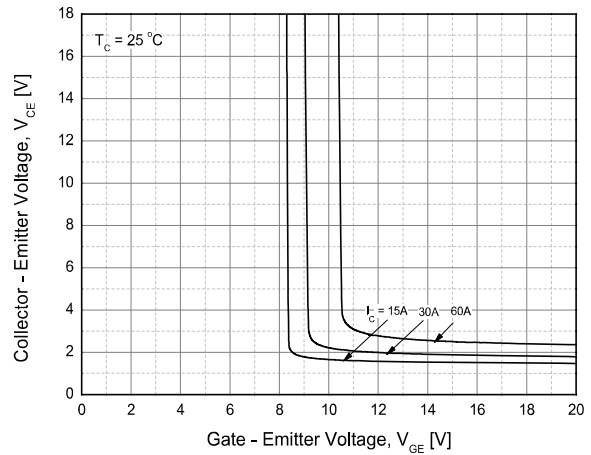

Fig. 5 Saturation voltage vs. gate bias

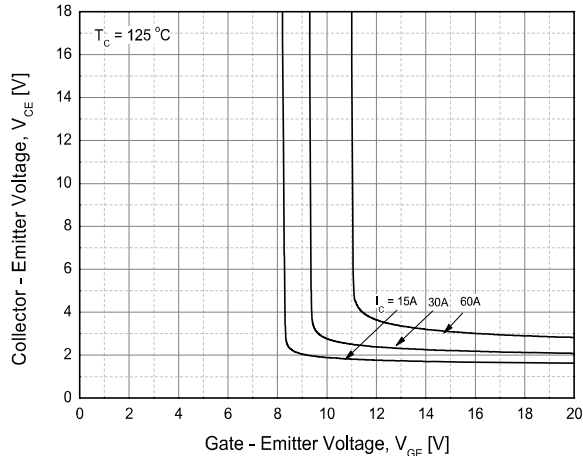
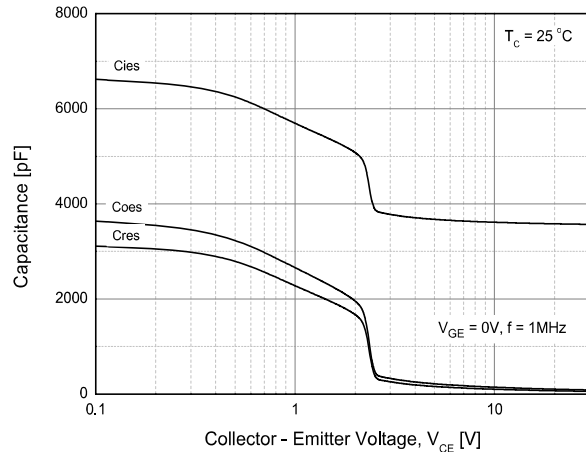

Fig. 6 Capacitance characteristics



## IGBT Characteristics

Fig. 7 Turn-on time vs. gate resistor

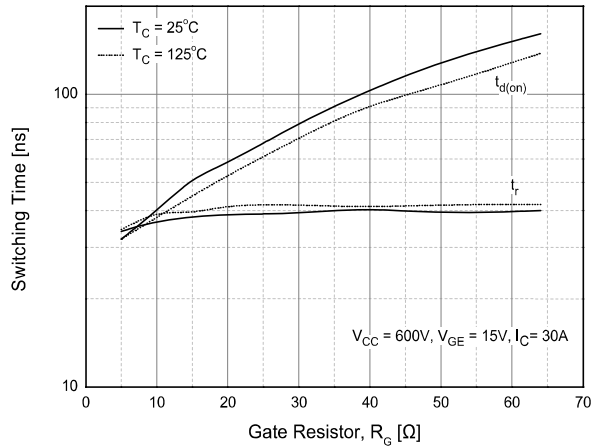

Fig. 8 Turn-off time vs. gate resistor

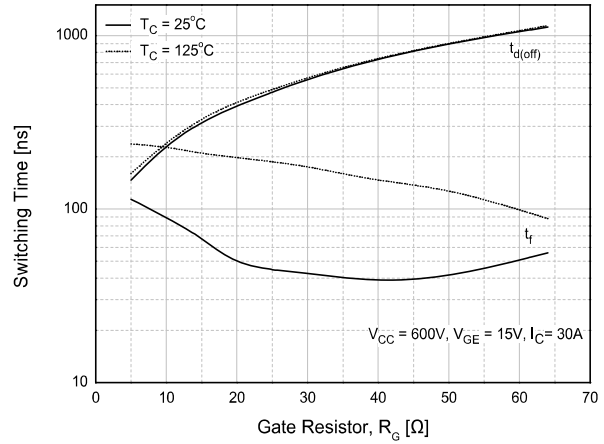

Fig. 9 Switching loss vs. gate resistor

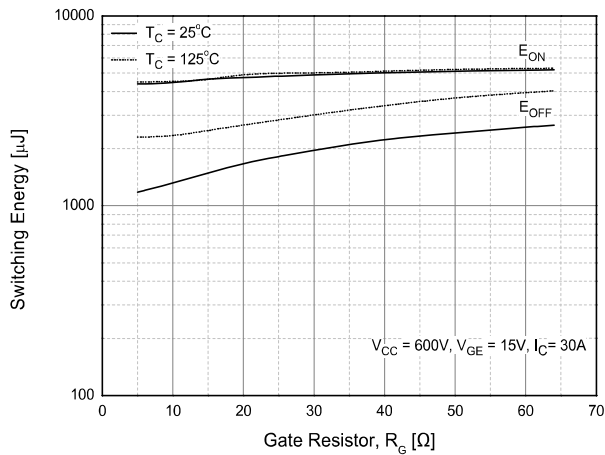

Fig. 10 Turn-on time vs. collector current

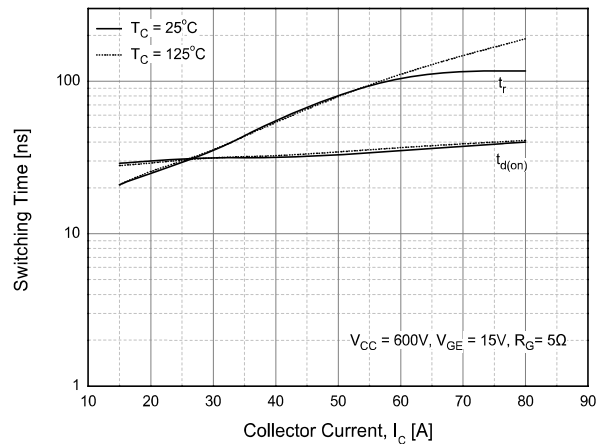

Fig. 11 Turn-off time vs. collector current

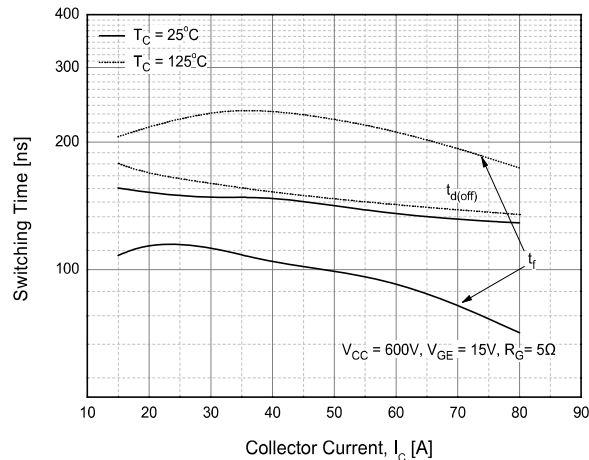
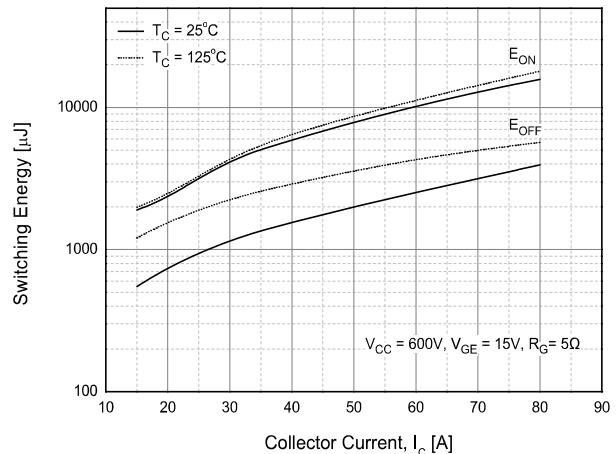

Fig. 12 Switching loss vs. collector current



## IGBT Characteristics

Fig. 13 Gate charge characteristics

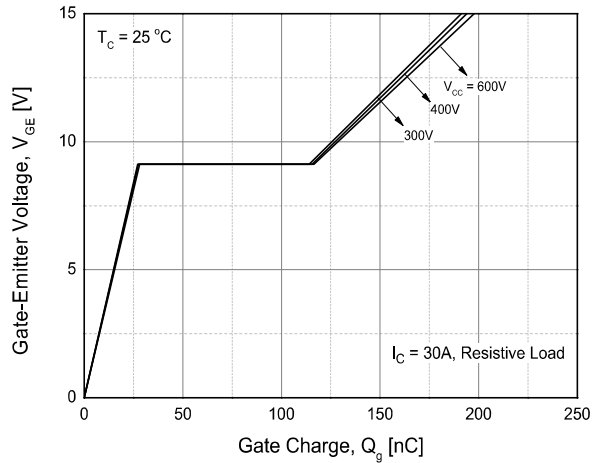

Fig. 14 SOA

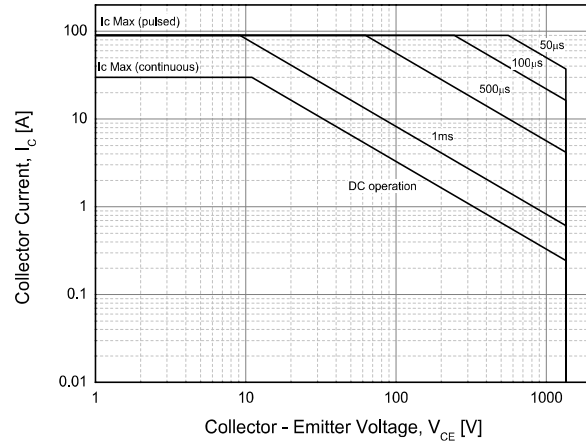

Fig. 15 RBSOA

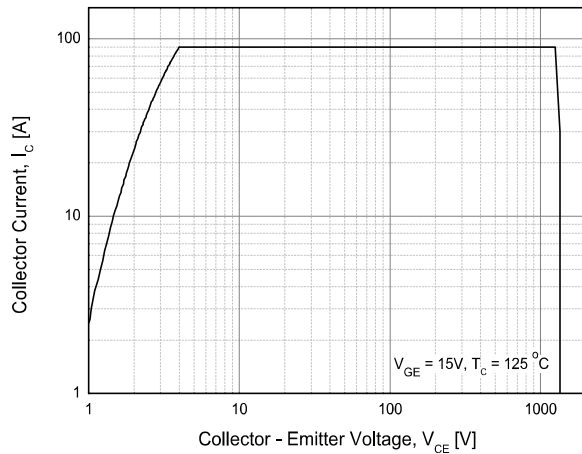

Fig. 16 Transient thermal impedance of IGBT

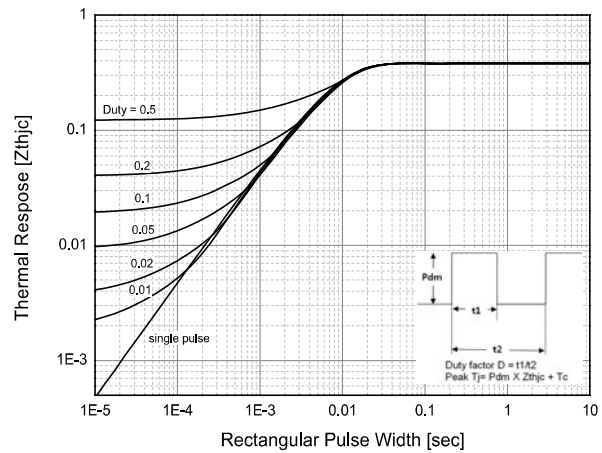
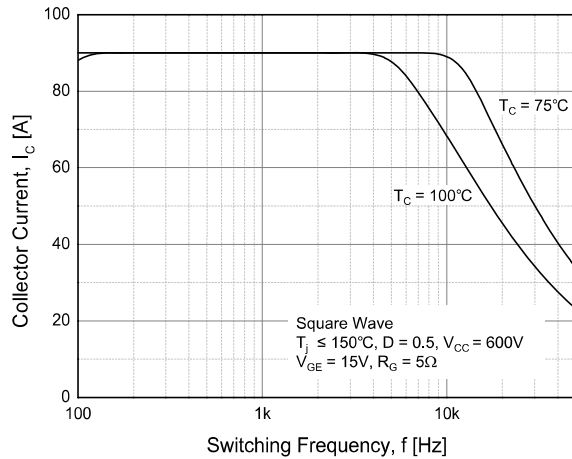

Fig. 17 Load Current vs. Frequency



## Diode Characteristics

Fig. 18 Conduction characteristics

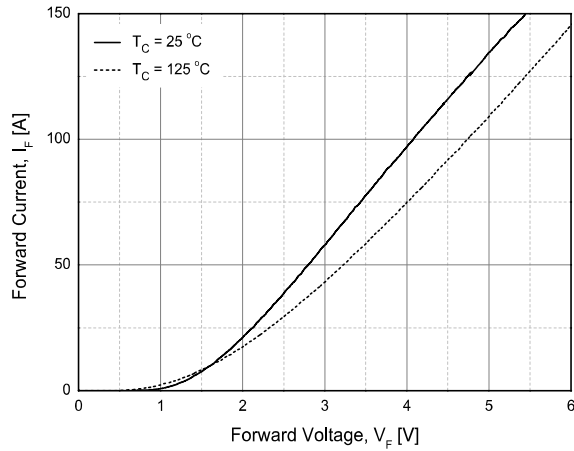

Fig. 19 Reverse recovery current vs. forward current

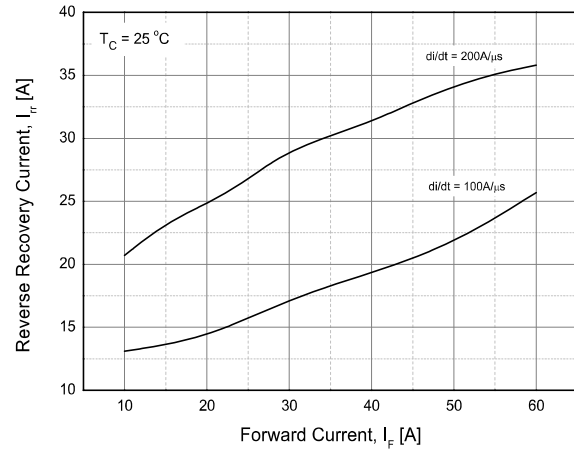

Fig. 20 Reverse recovery charge vs. forward current

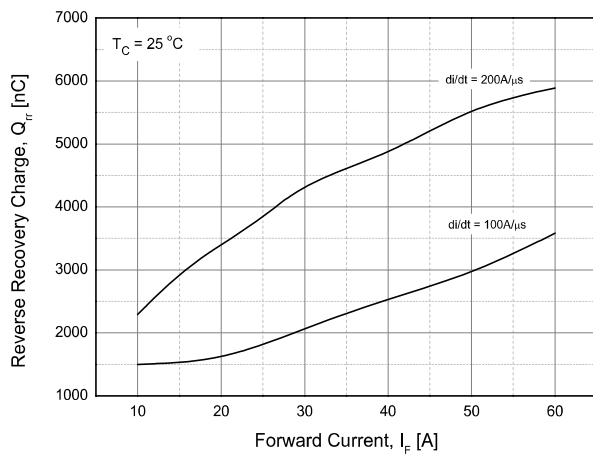
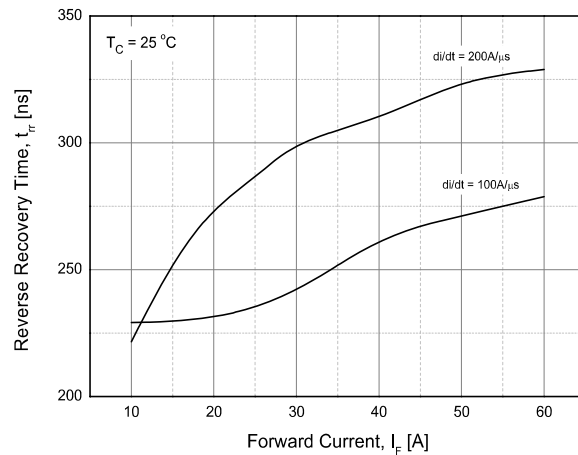
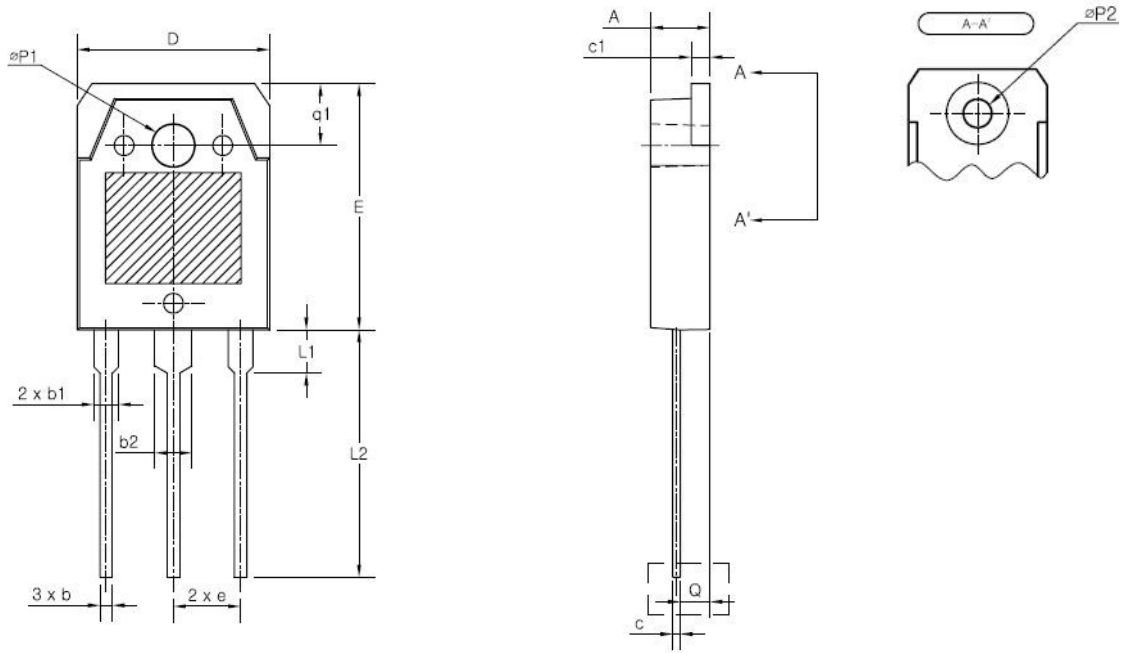

Fig. 21 Reverse recovery time vs. forward current



**TO-3PN MECHANICAL DATA**



SYMBOL	MIN	NOM	MAX
A	4.60	4.80	5.00
b	0.80	1.00	1.20
b1	1.80	2.00	2.20
b2	2.80	3.00	3.20
c	0.55	0.60	0.75
c1	1.45	1.50	1.65
D	15.40	15.60	15.80
E	19.70	19.90	20.10
e	5.15	5.45	5.75
L1	3.30	3.50	3.70
L2	19.80	20.00	20.20
øP1	3.30	3.40	3.50
øP2	(3.20)		
Q	2.20	2.40	2.60
q1	4.80	5.00	5.20



## Notes

- **RoHS Compliance**

The levels of RoHS restricted materials in this product are below the maximum concentration values (also referred to as the threshold limits) permitted for such substances, or are used in an exempted application, in accordance with EU Directive 2011/65/EC (RoHS2), as implemented March, 2013. RoHS Declarations for this product can be obtained from the Product Documentation sections of [www.gptechgroup.com](http://www.gptechgroup.com).

- **REACH Compliance**

REACH substances of high concern (SVHCs) information is available for this product. Since the European Chemical Agency (ECHA) has published notice of their intent to frequently revise the SVHC listing for the foreseeable future, please contact our office at GPTG Headquarters in Lake Forest, California to insure you get the most up-to-date REACH SVHC Declaration.

REACH banned substance information (REACH Article 67) is also available upon request.

- This product has not been designed or tested for use in, and is not intended for use in, applications implanted into the human body nor in applications in which failure of the product could lead to death, personal injury or property damage, including but not limited to equipment used in the operation of nuclear facilities, life-support machines, cardiac defibrillators or similar emergency medical equipment, aircraft navigation or communication or control systems, or air traffic control.

- To obtain additional technical information or to place an order for this product, please contact us. The information in this datasheet is provided by Global Power Technologies Group. GPTG reserves the right to make changes, corrections, modifications, and improvements of datasheet without notice.

### Global Power Technologies Group

20692 Prism Place

Lake Forest, CA 92630

TEL (949) 207-7500

FAX (949) 613-7600

E-mail: [info@gptechgroup.com](mailto:info@gptechgroup.com)

Web site: [www.gptechgroup.com](http://www.gptechgroup.com)

