

# TMR3005

## Dual-axis TMR Angle Sensor

### Description

TMR3005 angle sensor adopts two orthogonal push-pull Wheatstone bridge design, and each bridge contains four high-sensitivity TMR sensing elements to produce a best-in-class peak-to-peak output signal as large as 65% of the supply voltage, thereby eliminating many external signal amplifying and processing circuit needed in the applications. The voltage signal output by the two axes of the chip has a sine and cosine relationship with the angle of the magnetic field, when a magnet is placed above the TMR3005 chip to provide an operating magnetic field parallel to the surface of the chip in general angle sensor application. Additionally, the TMR full bridge technology accurately compensates the output against changes in ambient temperature. This high performance TMR3005 angle sensor is available in packaging form factors of compact LGA8L (3 mm × 3 mm × 0.75 mm).

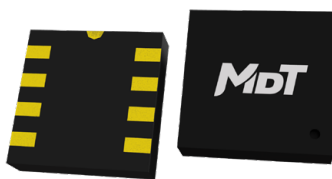

LGA8L

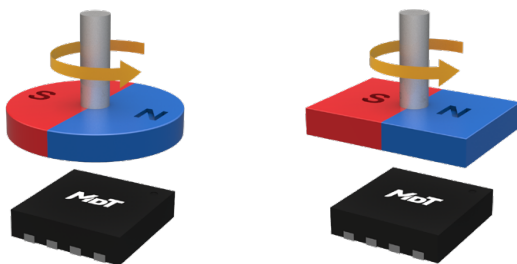

### Features and benefits

- Tunneling magnetoresistance (TMR) technology
- Large output signal without amplification
- Dual-axis 360° angle measurement
- Compatible with a wide range of supply voltages
- Low power consumption
- Large air gap tolerance
- Compact LGA package
- Excellent thermal stability

### Applications

- Rotary position sensors
- Rotary encoders
- Contactless potentiometers
- Valve position sensors
- Knob position sensors

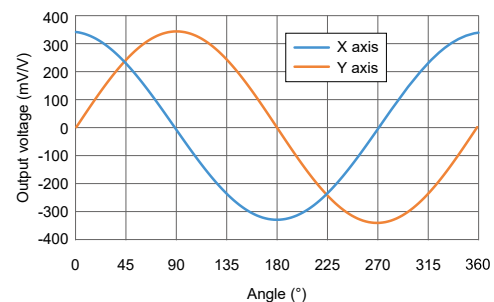

## Selection Guide

Part Number	Angle range	Bridge resistance	Peak voltage	Angular error	Package	Packing Form
TMR3005LG	360°	6 kΩ	340 mV/V	±0.6°	LGA8L	Tape & Reel
TMR3005G	360°	140 kΩ	340 mV/V	±0.6°	LGA8L	Tape & Reel
TMR3005HG	360°	1900 kΩ	340 mV/V	±0.6°	LGA8L	Tape & Reel

## Catalogue

1. Functional Block Diagram.....	03
2. Operating Principle.....	03
3. Pin Configuration.....	03
4. Absolute Maximum Ratings.....	04
5. Electrical Specifications.....	04
6. Dimensions.....	05

## 1. Functional Block Diagram

The TMR3005 angle sensors use dual Wheatstone bridges of high sensitivity TMR sensing elements to increase the sensors' output signal amplitude with enhanced temperature characteristic and anti-interference performance as shown in Figure 1.

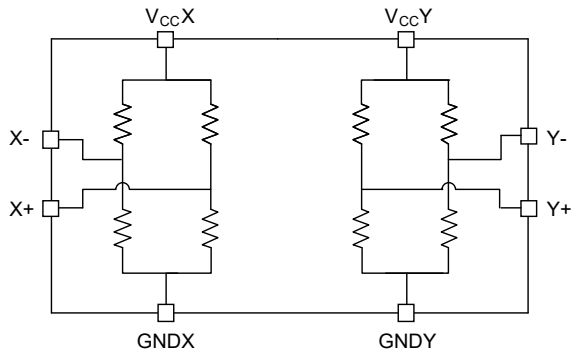

Figure 1. Block diagram

## 2. Operating Principle

The resistance value of the sensing elements changes with the target magnetic field, and the sensing direction is parallel to the chip surface as shown in Figure 2.

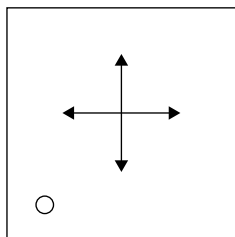

Figure 2. Sensing direction

A small dipole magnet, placed above the TMR3005, can provide a magnetic field in any desired orientation parallel to the plane of the TMR3005 package. When the Angle of the applied magnetic field changes, the output voltage waveform of the sensor is a cosine curve as shown in Figure 3.

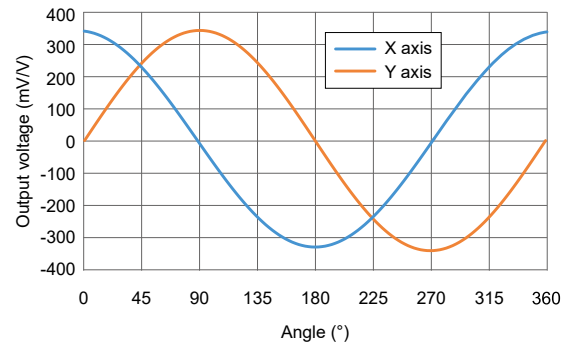

Figure 3. Typical output curve

## 3. Pin Configuration

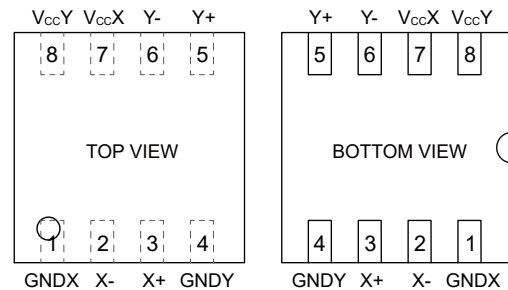

Figure 4. Pin configuration (LGA8L)

Number	Name	Function
1	GNDX	Ground (X axis)
2	X-	Analog Differential Output 2 (X axis)
3	X+	Analog Differential Output 1 (X axis)
4	GNDY	Ground (Y axis)
5	Y+	Analog Differential Output1 (Y axis)
6	Y-	Analog Differential Output2 (Y axis)
7	V <sub>cc</sub> X	Supply Voltage (X axis)
8	V <sub>cc</sub> Y	Supply Voltage (Y axis)

## 4. Absolute Maximum Ratings

Parameters	Symbol	Min.	Max.	Unit
Supply voltage	$V_{CC}$	-	19	V
Magnetic flux density	$B$	-	3000	Gs
ESD performance (HBM)	$V_{ESD}$	-	4000	V
Operating ambient temperature	$T_A$	-40	85	°C
Storage ambient temperature	$T_{STG}$	-40	150	°C

## 5. Electrical Specifications

$V_{CC} = 5\text{ V}$ ,  $T_A = 25\text{ °C}$ , a  $0.1\text{ }\mu\text{F}$  capacitor is connected between  $V_{CC}$  and GND

Parameter	Symbol	Condition	Min.	Typ.	Max.	Unit	Applicable Part Number
Supply voltage	$V_{CC}$	Operating	-	1	7	V	All parts
Bridge resistance	$R_B$	Operating	2	6 <sup>1)</sup>	9	k $\Omega$	TMR3005LG
			100	140	190	k $\Omega$	TMR3005G
			1400	1900	2800	k $\Omega$	TMR3005HG
Peak voltage	$V_{PEAK}$	Operating	-	340 <sup>2)</sup>	-	mV/V	All parts
Offset voltage	$V_{OFFSET}$	Operating	-20	-	20	mV/V	All parts
Magnetic field	$H_{ext}$	Operating	200	-	800	Gs	All parts
Angular error	$\Delta\theta$	Operating	-	$\pm 0.6$	-	°	All parts
Operation coefficient of peak voltage	$TCV_{PEAK}$	$T_J = -40\text{ °C to }85\text{ °C}$	-	-970	-	PPM/°C	All parts

Notes:

- 1)  $V_{CC}$  - GND resistance of single axis, customizable upon request.
- 2)  $V_{PEAK}$  is the amplitude of the output sinusoidal voltage, which equals to half of the peak-to-peak value ( $V_{P-P}$ ).

## 6. Dimensions

### LGA8L Package

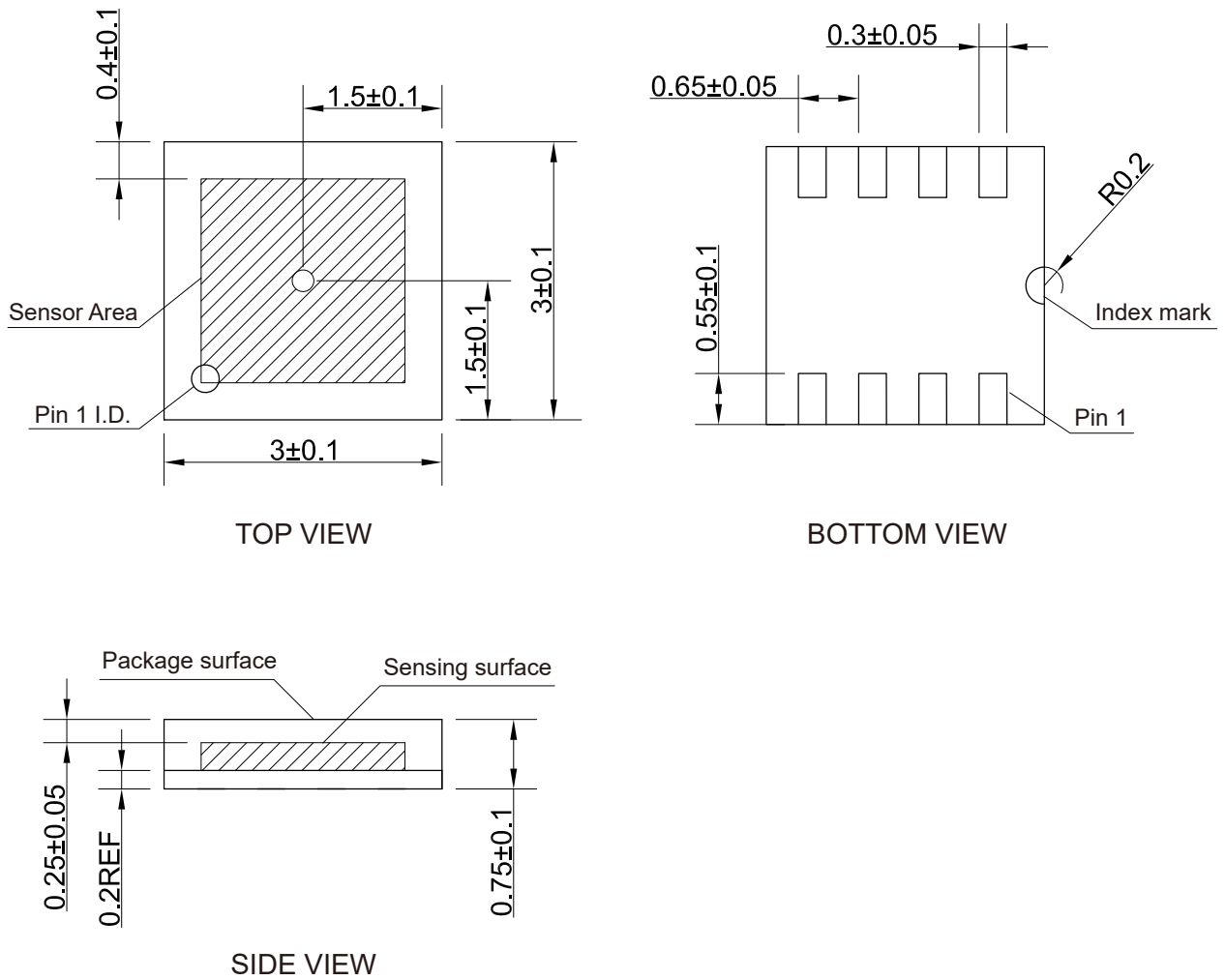

Figure 5. Package outline of LGA8L (unit: mm)

Copyright © 2022 by MultiDimension Technology Co., Ltd.

Information furnished herein by MultiDimension Technology Co., Ltd. (hereinafter MDT) is believed to be accurate and reliable. However, MDT disclaims any and all warranties and liabilities of any kind, with respect to any examples, hints or any performance or use of technical data as described herein and/or any information regarding the application of the product, including without limitation warranties of non-infringement of intellectual property rights of any third party. This document neither conveys nor implies any license under patent or other industrial or intellectual property rights. Customer or any third-party must further determine the suitability of the MDT products for its applications to avoid the applications default of customer or third-party. MDT accept no liability in this respect.

MDT does not assume any liabilities of any indirect, incidental, punitive, special or consequential damages (including without limitation of lost profits, lost savings, business interruption, costs related to the removal or replacement of any products or rework charges) whether or not such damages are based on tort (including negligence), warranty, breach of contract or any other legal theory. Notwithstanding any damages that customer might incur for any reason whatsoever, MDT's aggregate and cumulative liability towards customer for the products described herein shall be limited in accordance with the terms and conditions of commercial sale of MDT.

Absolute maximum ratings are the extreme limits the device will withstand without damage to the MDT product. However, the electrical and mechanical characteristics are not guaranteed as the maximum limits (above recommended operating conditions) are approached. MDT disclaims any and all warranties and liabilities of the MDT product will operate at absolute maximum ratings.

Specifications may change without notice.

Please download latest document from our official website [www.dowaytech.com/en](http://www.dowaytech.com/en).

## Recycling

The product(s) in this document need to be handed over to a qualified solid waste management services company for recycling in accordance with relevant regulations on waste classification after the end of the product(s) life.



No.2 Guangdong Road, Zhangjiagang Free Trade Zone, Jiangsu, China

Web: [www.dowaytech.com/en](http://www.dowaytech.com/en) E-mail: [info@dowaytech.com](mailto:info@dowaytech.com)

