



SPECIFICATION SHEET

SPECIFICATION SHEET NO.	Q1122- BDBCW2MMV7LMFC	
DATE	Nov. 22, 2023	
REVISION	A0	Updated With Most Recent Data - Official First Release
DESCRIPTION AND MAIN PARAMETRICS	<p>Automotive PLCC-2 TOP LED SMD 3528 Dimension L3.50*W2.80*H1.85mm Colorless and Clear Lens Transparency, 2.4mm Dia Lens Round with Flat Top Color Cool White, 0.1W, Forward Voltage (V7) 2.8~3.0V Color Bin Rank (LM) 6500~7000K Luminous Intensity Rank (FC) 1890~2290mcd Operating Temp. Range -40°C ~+110°C Package in Tape/Reel, REACH/RoHS/RoHS III Compliant</p>	
CUSTOMER		
CUSTOMER PART NO.		
CROSS REF. PART NO.		
ORIGINAL MFG/PART NO.	BNDLight/BDB-CW2MM-V7LMFC	
PART CODE	BDBCW2MMV7LMFC	

VENDOR APPROVE			
Issued/Checked/Approved			
DATE: Nov. 22, 2023			

CUSTOMER APPROVE	
DATE:	

AUTOMOTIVE SMD TOP LED PLCC-2 3528 BDB-CW2MM SERIES

MAIN FEATURE

- Cool White PLCC-2 Package
- Emitting Material: InGaAlP Chip
- Low Light Attenuation and High Brightness
- Luminous Intensity@20mA: 1170~3600mcd
- View Angle at 50% Iv of 120°
- 100% Pure Gold Wire
- Excellent Stability and Thermostability
- Corrosion Robustness: Excellent Corrosion Robustness
- Suitable for SMT process
- Cross Competitors Parts
- REACH/RoHS/RoHS III Compliant



APPLICATION

- Auto Signaling
- Auto Lighting Interior and Exterior
- Signal and Symbol Luminary

RFQ
Request For Quotation

PART CODE GUIDE

BDB	CW2MM	V7	LM	FC	()
1	2	3	4	5	6

1. BDB: PLCC-2 Package TOP LED SMD 3528 Dimension L3.50*W2.80*H1.85mm
2. CW2MM: 0.1W Color Cool White
3. V7: Bin Code, Forward Voltage: 2.8~3.0V, see Page 5
4. LM: Bin Code, Color Bin Rank: 6500~7000K, see Page 5
5. FC: Bin Code, Luminous Intensity Rank: 1890~2290mcd, see Page 5
6. () : Internal Control Code or special Parameters code letter A~Z or digits (1-9); Blank: N/A

ELECTRICAL CHARACTERISTICS

See Page 7 ~Page 10 For Different Part Code

HOW TO ORDER

Please indicate part code and send us your RFQ by E-mail, sales@nextgencomponent.com

AUTOMOTIVE SMD TOP LED PLCC-2 3528 BDB-CW2MM SERIES

DIMENSION – (Unit: mm, Tol.: +/-0.1mm)

Image For Reference



Cool White

BDB Series

Size Code 3528

Dimension

L3.50*W2.80*H1.85mm

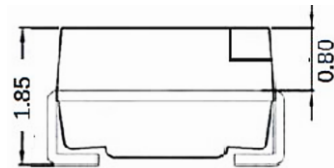
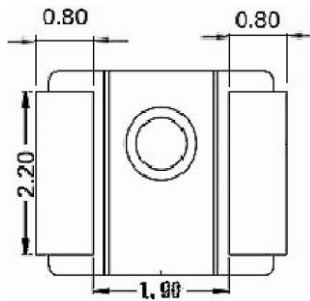
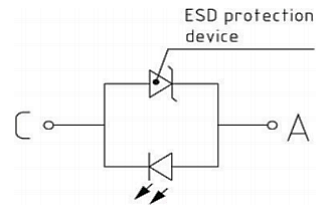
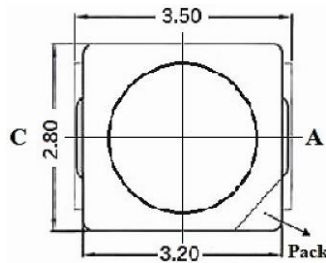

Recommend

Pad Layout

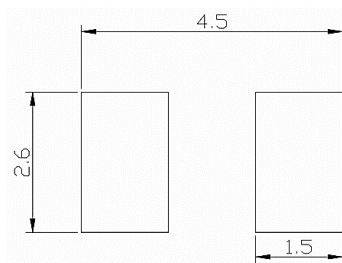

AUTOMOTIVE SMD TOP LED PLCC-2 3528 BDB-CW2MM SERIES
MAXIMUM RATINGS Ts=25°C, RH60%

Parameters	Symbol	Values	Unit
Operating Temperature	Top	-40~+110	°C
Storage Temperature	Tstg	-40~+110	°C
Junction Temperature	Tj	125	°C
Forward Current (Ts=25°C)	IF	50	mA
Surge Current (t≤10μs; D=0.005; Ts=25°C)	IFs	300	mA
Reverse Voltage (Ts=25°C)	VR	5	V
Electrostatic Discharge (acc.to ANSI/ESDA/JEDEC JS-001-2017)	VESD	≥8	kV

OPTICAL & ELECTRICAL CHARACTERISTICS IF=20mA, Ts=25°C, RH60%

Parameters	Symbol	Values			Unit
		Min.	Typ.	Max.	
Color Temperature	CCT	5000	/	7000	K
Forward Current	IF	1.5	/	50	mA
Chromaticity coordinates	Cx/Cy	/	0.33/0.33	/	
Viewing Angle	2θ 1/2	/	120	/	Deg
Forward Voltage	VF	2.65	/	3.4	V
Reverse Current	IR (VR=5V)	/	0.1	10	μA
Thermal Resistance junction/solder point	Rth(j-sp)real	/	153	183	K/W
Electrical Thermal Resistance junction/solder point with efficiency η=31%	Rth(j-sp)elec	/	102	129	K/W

AUTOMOTIVE SMD TOP LED PLCC-2 3528 BDB-CW2MM SERIES

BIN CODE LIST

Parameters	Symbol	Values	Tolerance	Unit
Forward Voltage Rank (VF) @IF=20mA, Ts=25°C, RH60%	V6	2.65~2.8	±0.05	V
	V7	2.8~3.0		
	V8	3.0~3.2		
	V9	3.2~3.4		
Color Bin Rank (CCT) @IF=20mA, Ts=25°C, RH60%	IM	5000~5500	±0.03 (see Note 1)	K
	HM	5500~6000		
	GM	6000~6500		
	LM	6500~7000		
Luminous Intensity Rank (IV) @IF=20mA, Ts=25°C, RH60%	FA	1170~1460	±5.0%	mcd
	FB	1460~1890		
	FC	1890~2290		
	FD	2290~2880		
	FE	2880~3600		

Note: 1) Tolerance of measurements of the Cx,Cy is ±0.03.

AUTOMOTIVE SMD TOP LED PLCC-2 3528 BDB-CW2MM SERIES

CHROMATICITY REGION & COORDINATE @IF=20mA, Ts=25°C, RH60%

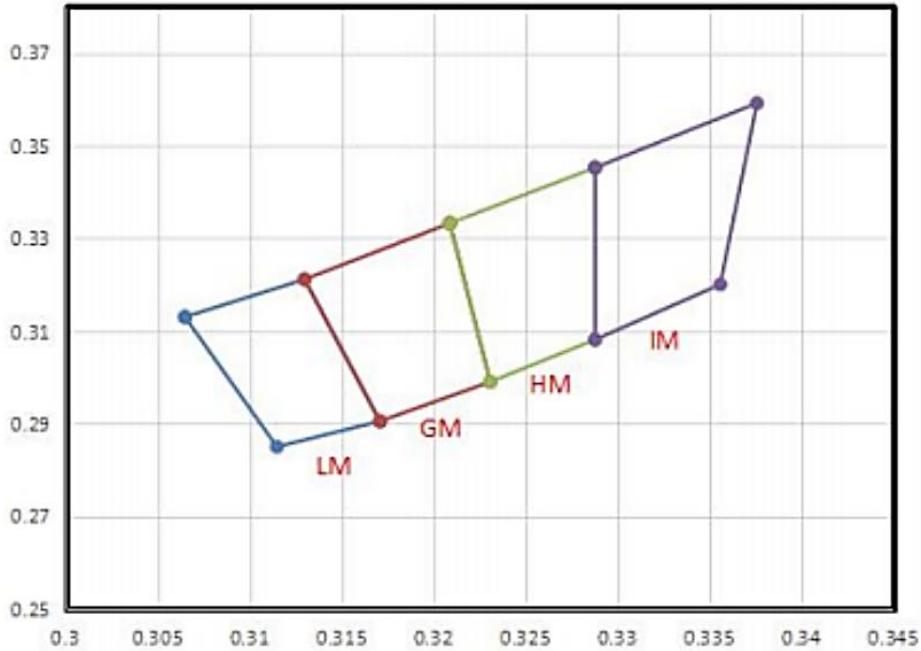

IM (K)		HM (K)		GM (K)		LM (K)	
5000~5500		5500~6000		6000~6500		6500~7000	
Cx	Cy	Cx	Cy	Cx	Cy	Cx	Cy
0.3288	0.3452	0.3288	0.3452	0.3209	0.3332	0.3065	0.3130
0.3288	0.3081	0.3288	0.3081	0.3231	0.2990	0.3115	0.2850
0.3356	0.3200	0.3231	0.2990	0.3171	0.2905	0.3171	0.2905
0.3376	0.3591	0.3209	0.3332	0.3130	0.3211	0.3130	0.3211

Note: 1) Tolerance of measurements of the Cx,Cy is ± 0.03 .

AUTOMOTIVE SMD TOP LED PLCC-2 3528 BDB-CW2MM SERIES
ELECTRICAL CHARACTERISTICS IF=20mA, Ts=25°C, RH60%, Tol. :±0.05V

Part Code	Forward Voltage - VF (V)	Color Bin Rank - CCT (K)	Luminous Intensity - IV (mcd)
BDBCW2MMV6IMFA	2.65~2.8	5000~5500	1170~1460
BDBCW2MMV6IMFB	2.65~2.8	5000~5500	1460~1890
BDBCW2MMV6IMFC	2.65~2.8	5000~5500	1890~2290
BDBCW2MMV6IMFD	2.65~2.8	5000~5500	2290~2880
BDBCW2MMV6IMFE	2.65~2.8	5000~5500	2880~3600
BDBCW2MMV6HMFA	2.65~2.8	5500~6000	1170~1460
BDBCW2MMV6HMF B	2.65~2.8	5500~6000	1460~1890
BDBCW2MMV6HMFC	2.65~2.8	5500~6000	1890~2290
BDBCW2MMV6HMFD	2.65~2.8	5500~6000	2290~2880
BDBCW2MMV6HMFE	2.65~2.8	5500~6000	2880~3600
BDBCW2MMV6GMFA	2.65~2.8	6000~6500	1170~1460
BDBCW2MMV6GMFB	2.65~2.8	6000~6500	1460~1890
BDBCW2MMV6GMFC	2.65~2.8	6000~6500	1890~2290
BDBCW2MMV6GMFD	2.65~2.8	6000~6500	2290~2880
BDBCW2MMV6GMFE	2.65~2.8	6000~6500	2880~3600
BDBCW2MMV6LMFA	2.65~2.8	6500~7000	1170~1460
BDBCW2MMV6LMFB	2.65~2.8	6500~7000	1460~1890
BDBCW2MMV6LMFC	2.65~2.8	6500~7000	1890~2290
BDBCW2MMV6LMFD	2.65~2.8	6500~7000	2290~2880
BDBCW2MMV6LMFE	2.65~2.8	6500~7000	2880~3600

AUTOMOTIVE SMD TOP LED PLCC-2 3528 BDB-CW2MM SERIES

ELECTRICAL CHARACTERISTICS IF=20mA, Ts=25°C, RH60%, Tol. :±0.05V

Part Code	Forward Voltage - VF (V)	Color Bin Rank - CCT (K)	Luminous Intensity - IV (mcd)
BDBCW2MMV7IMFA	2.8~3.0	5000~5500	1170~1460
BDBCW2MMV7IMFB	2.8~3.0	5000~5500	1460~1890
BDBCW2MMV7IMFC	2.8~3.0	5000~5500	1890~2290
BDBCW2MMV7IMFD	2.8~3.0	5000~5500	2290~2880
BDBCW2MMV7IMFE	2.8~3.0	5000~5500	2880~3600
BDBCW2MMV7HMFA	2.8~3.0	5500~6000	1170~1460
BDBCW2MMV7HMF B	2.8~3.0	5500~6000	1460~1890
BDBCW2MMV7HMFC	2.8~3.0	5500~6000	1890~2290
BDBCW2MMV7HMFD	2.8~3.0	5500~6000	2290~2880
BDBCW2MMV7HMFE	2.8~3.0	5500~6000	2880~3600
BDBCW2MMV7GMFA	2.8~3.0	6000~6500	1170~1460
BDBCW2MMV7GMFB	2.8~3.0	6000~6500	1460~1890
BDBCW2MMV7GMFC	2.8~3.0	6000~6500	1890~2290
BDBCW2MMV7GMFD	2.8~3.0	6000~6500	2290~2880
BDBCW2MMV7GMFE	2.8~3.0	6000~6500	2880~3600
BDBCW2MMV7LMFA	2.8~3.0	6500~7000	1170~1460
BDBCW2MMV7LMFB	2.8~3.0	6500~7000	1460~1890
BDBCW2MMV7LMFC	2.8~3.0	6500~7000	1890~2290
BDBCW2MMV7LMFD	2.8~3.0	6500~7000	2290~2880
BDBCW2MMV7LMFE	2.8~3.0	6500~7000	2880~3600

AUTOMOTIVE SMD TOP LED PLCC-2 3528 BDB-CW2MM SERIES
ELECTRICAL CHARACTERISTICS IF=20mA, Ts=25°C, RH60%, Tol. :±0.05V

Part Code	Forward Voltage - VF (V)	Color Bin Rank - CCT (K)	Luminous Intensity - IV (mcd)
BDBCW2MMV8IMFA	3.0~3.2	5000~5500	1170~1460
BDBCW2MMV8IMFB	3.0~3.2	5000~5500	1460~1890
BDBCW2MMV8IMFC	3.0~3.2	5000~5500	1890~2290
BDBCW2MMV8IMFD	3.0~3.2	5000~5500	2290~2880
BDBCW2MMV8IMFE	3.0~3.2	5000~5500	2880~3600
BDBCW2MMV8HMFA	3.0~3.2	5500~6000	1170~1460
BDBCW2MMV8HMF B	3.0~3.2	5500~6000	1460~1890
BDBCW2MMV8HMFC	3.0~3.2	5500~6000	1890~2290
BDBCW2MMV8HMFD	3.0~3.2	5500~6000	2290~2880
BDBCW2MMV8HMFE	3.0~3.2	5500~6000	2880~3600
BDBCW2MMV8GMFA	3.0~3.2	6000~6500	1170~1460
BDBCW2MMV8GMFB	3.0~3.2	6000~6500	1460~1890
BDBCW2MMV8GMFC	3.0~3.2	6000~6500	1890~2290
BDBCW2MMV8GMFD	3.0~3.2	6000~6500	2290~2880
BDBCW2MMV8GMFE	3.0~3.2	6000~6500	2880~3600
BDBCW2MMV8LMFA	3.0~3.2	6500~7000	1170~1460
BDBCW2MMV8LMFB	3.0~3.2	6500~7000	1460~1890
BDBCW2MMV8LMFC	3.0~3.2	6500~7000	1890~2290
BDBCW2MMV8LMFD	3.0~3.2	6500~7000	2290~2880
BDBCW2MMV8LMFE	3.0~3.2	6500~7000	2880~3600

AUTOMOTIVE SMD TOP LED PLCC-2 3528 BDB-CW2MM SERIES

ELECTRICAL CHARACTERISTICS IF=20mA, Ts=25°C, RH60%, Tol. :±0.05V

Part Code	Forward Voltage - VF (V)	Color Bin Rank - CCT (K)	Luminous Intensity - IV (mcd)
BDBCW2MMV9IMFA	3.2~3.4	5000~5500	1170~1460
BDBCW2MMV9IMFB	3.2~3.4	5000~5500	1460~1890
BDBCW2MMV9IMFC	3.2~3.4	5000~5500	1890~2290
BDBCW2MMV9IMFD	3.2~3.4	5000~5500	2290~2880
BDBCW2MMV9IMFE	3.2~3.4	5000~5500	2880~3600
BDBCW2MMV9HMFA	3.2~3.4	5500~6000	1170~1460
BDBCW2MMV9HMF B	3.2~3.4	5500~6000	1460~1890
BDBCW2MMV9HMFC	3.2~3.4	5500~6000	1890~2290
BDBCW2MMV9HMFD	3.2~3.4	5500~6000	2290~2880
BDBCW2MMV9HMFE	3.2~3.4	5500~6000	2880~3600
BDBCW2MMV9GMFA	3.2~3.4	6000~6500	1170~1460
BDBCW2MMV9GMFB	3.2~3.4	6000~6500	1460~1890
BDBCW2MMV9GMFC	3.2~3.4	6000~6500	1890~2290
BDBCW2MMV9GMFD	3.2~3.4	6000~6500	2290~2880
BDBCW2MMV9GMFE	3.2~3.4	6000~6500	2880~3600
BDBCW2MMV9LMFA	3.2~3.4	6500~7000	1170~1460
BDBCW2MMV9LMFB	3.2~3.4	6500~7000	1460~1890
BDBCW2MMV9LMFC	3.2~3.4	6500~7000	1890~2290
BDBCW2MMV9LMFD	3.2~3.4	6500~7000	2290~2880
BDBCW2MMV9LMFE	3.2~3.4	6500~7000	2880~3600

AUTOMOTIVE SMD TOP LED PLCC-2 3528 BDB-CW2MM SERIES

REFLOW SOLDERING CHARACTERISTICS

Product complies to MSL Level 2a acc. To JEDEC J-STD-020 D.01

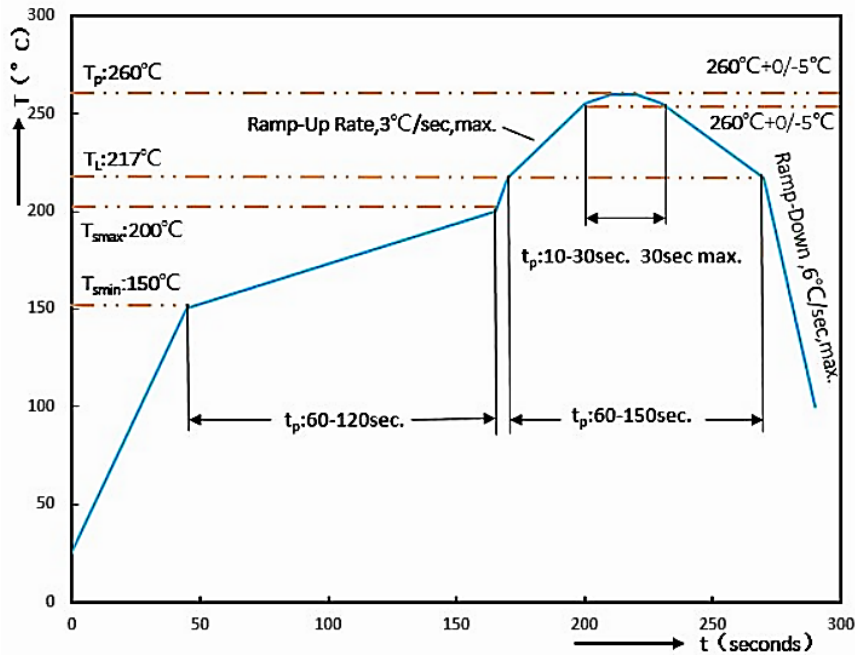

Profile Feature		Pb-Free Assembly
Average Ramp-up Rate (Ts Max to Tp)		3°C/second Max
Preheat	Temperature Min (Ts Min.)	150°C
	Temperature Max (Ts Max.)	200°C
	Time (ts Min. to ts Max.)	60 ~ 120 seconds
Time maintained above	Temperature (Tl)	217°C
	Time (tl)	60 ~ 150 seconds
Peak/Classification Temperature (Tp)		260 °C
Time within 5°C of actual Peak Temperature (tp)		30 seconds Max
Ramp-down rate		6 °C /Second Max.
Time 25 °C to Peak Temperature		8 minutes Max.
Suggest reflow times		3 Times Max.

AUTOMOTIVE SMD TOP LED PLCC-2 3528 BDB-CW2MM SERIES

OPTICAL & ELECTRICAL CHARACTERISTICS CURVES -IF=20mA, Ts=25°C, RH60%

Figure 1. Relative Spectral Emission, $I_{rel}=f(\lambda)$

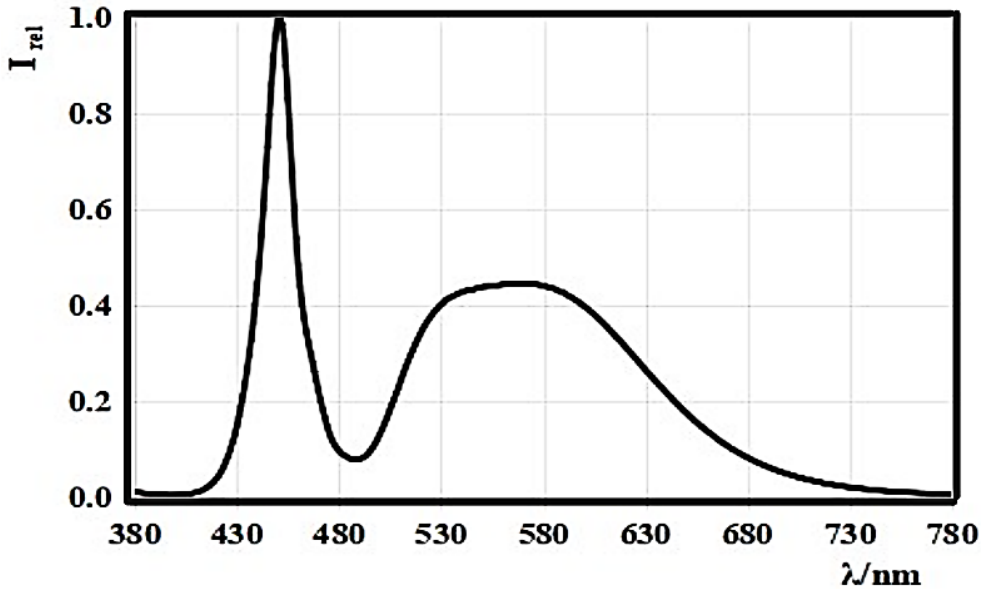
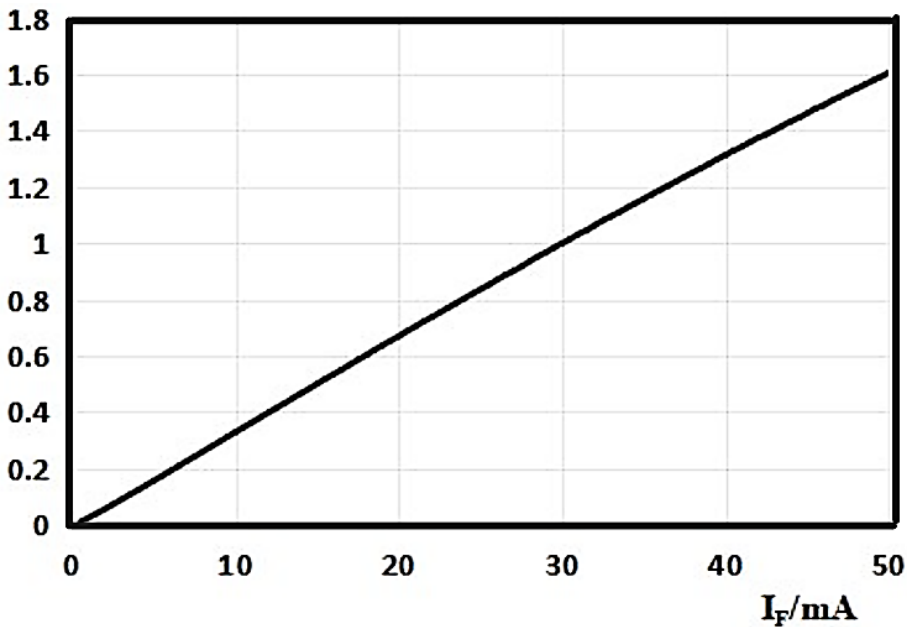

Figure 2. Forward Current Vs. Relative Intensity, $\Phi_V/\Phi_V(20mA)=f(I_F)$



AUTOMOTIVE SMD TOP LED PLCC-2 3528 BDB-CW2MM SERIES

OPTICAL & ELECTRICAL CHARACTERISTICS CURVES -IF=20mA, Ts=25°C, RH60%

Figure 3. Forward Voltage Vs. Forward Current, $I_F = f(V_F)$

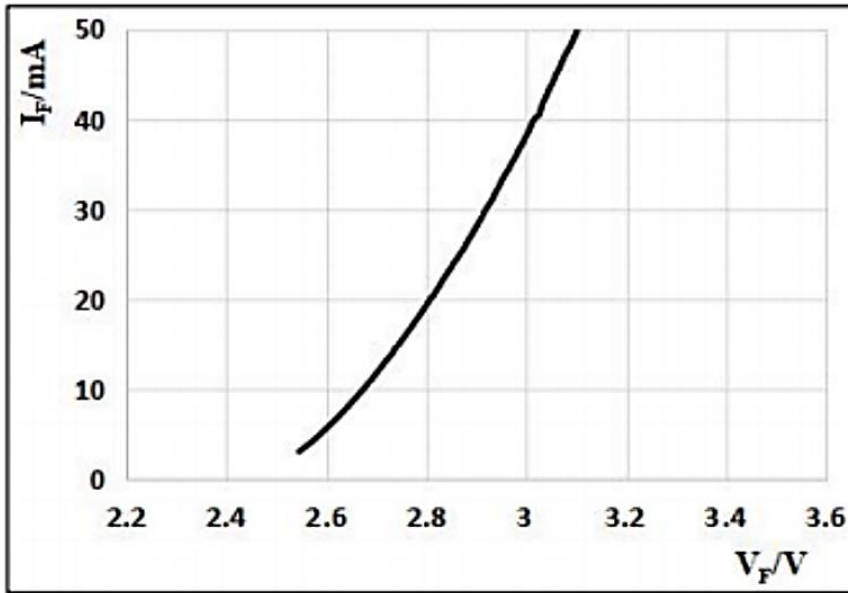
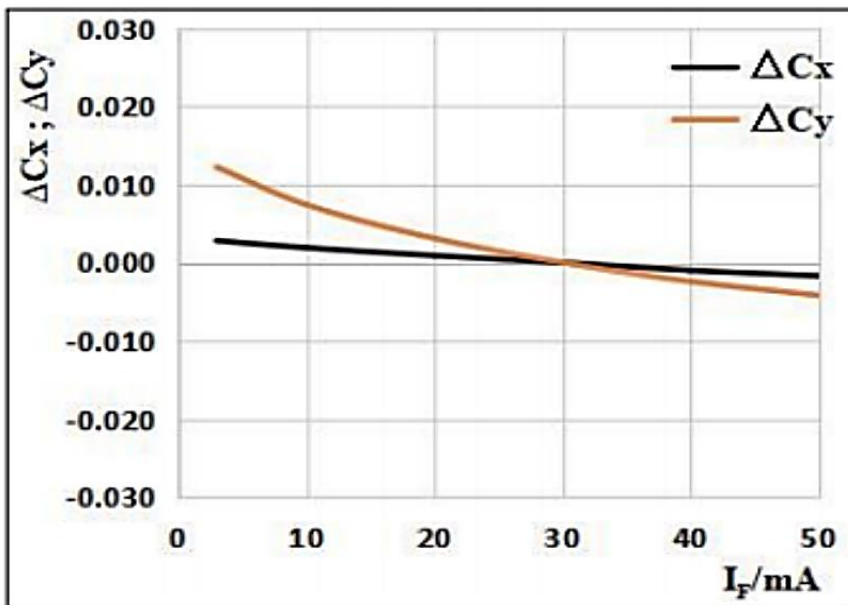

Figure 4. I_F Vs. Chromaticity Coordinate, ($\Delta C_x, \Delta C_y = f(I_F)$)



AUTOMOTIVE SMD TOP LED PLCC-2 3528 BDB-CW2MM SERIES

OPTICAL & ELECTRICAL CHARACTERISTICS CURVES -IF=20mA, Ts=25°C, RH60%

Figure 5. Junction Temperature Vs. Relative Intensity, $\Phi_V/\Phi_V(25^\circ\text{C}) = f(T_j)$

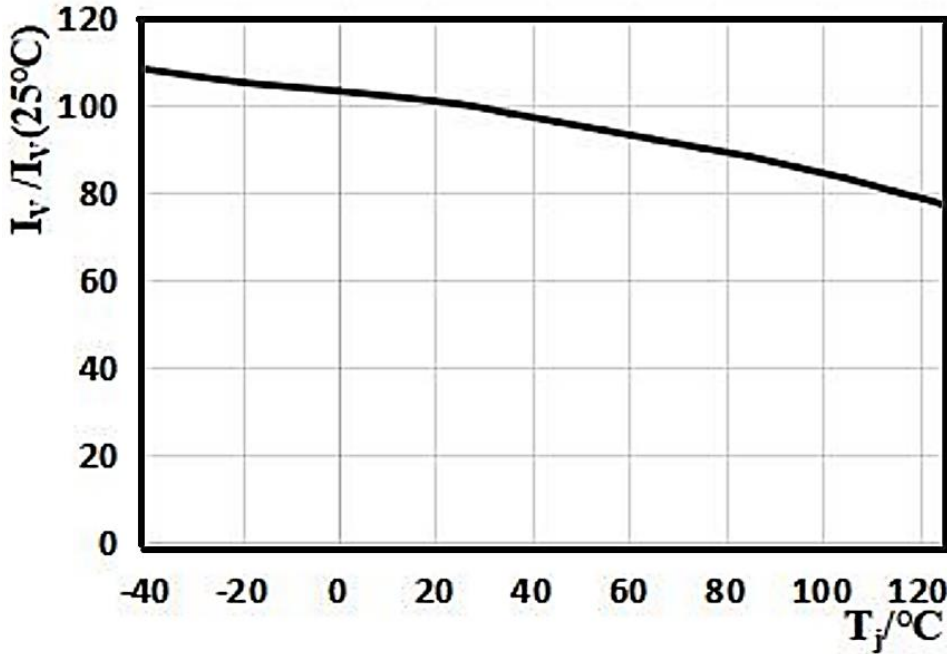
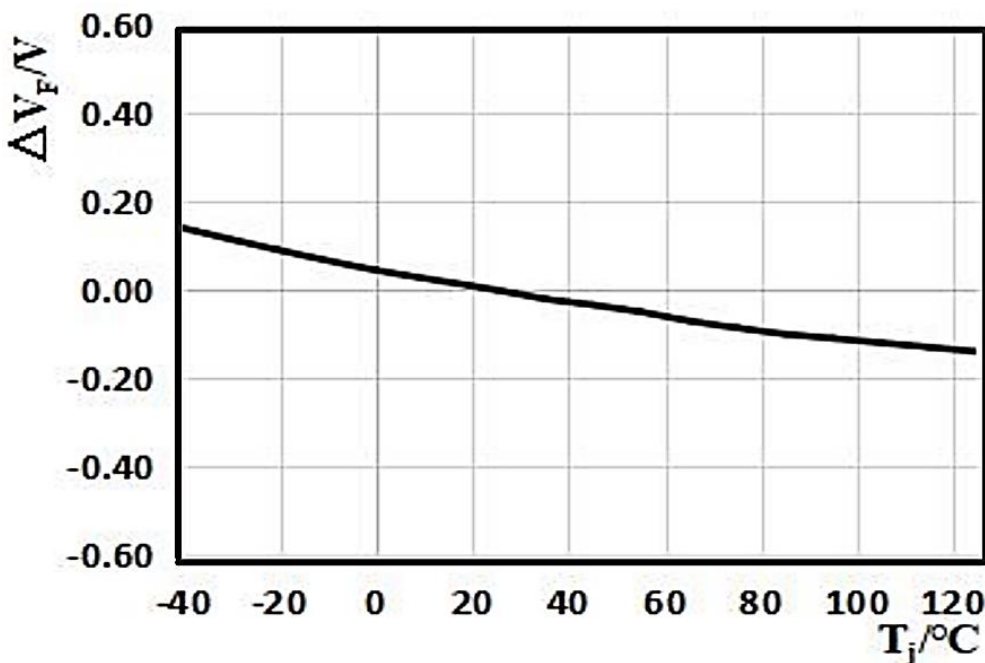

Figure 6. Junction Temperature Vs. ΔV_F , $\Delta V_F = V_F - V_F(25^\circ\text{C}) = f(T_j)$



AUTOMOTIVE SMD TOP LED PLCC-2 3528 BDB-CW2MM SERIES

OPTICAL & ELECTRICAL CHARACTERISTICS CURVES -IF=20mA, Ts=25°C, RH60%

Figure 7. Junction Temperature Vs. Chromaticity Coordinate, $\Delta C_x, \Delta C_y = f(T_j)$

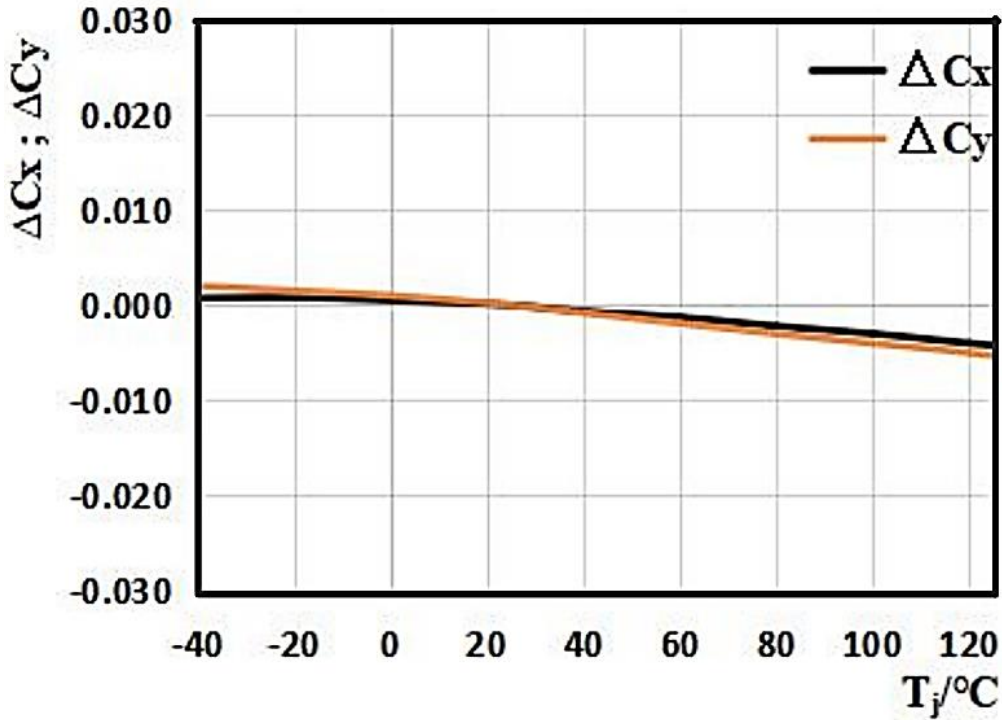
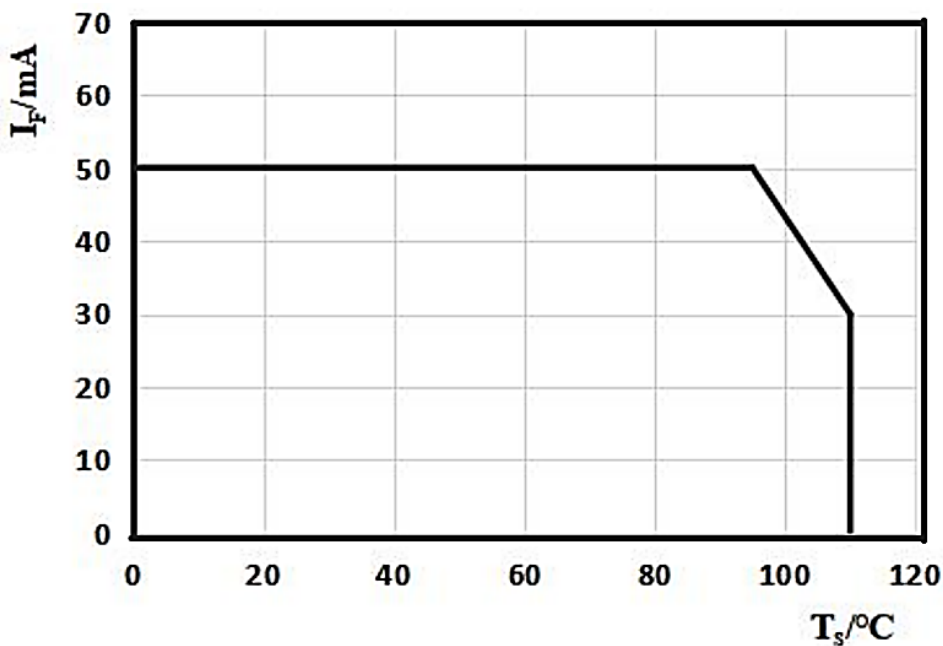

Figure 8 T_s Vs. Max. Permissible IF, $I_F = f(T_s)$



AUTOMOTIVE SMD TOP LED PLCC-2 3528 BDB-CW2MM SERIES

OPTICAL & ELECTRICAL CHARACTERISTICS CURVES -IF=20mA, Ts=25°C, RH60%

Figure 9. Radiation diagram, Irel = f (Φ)

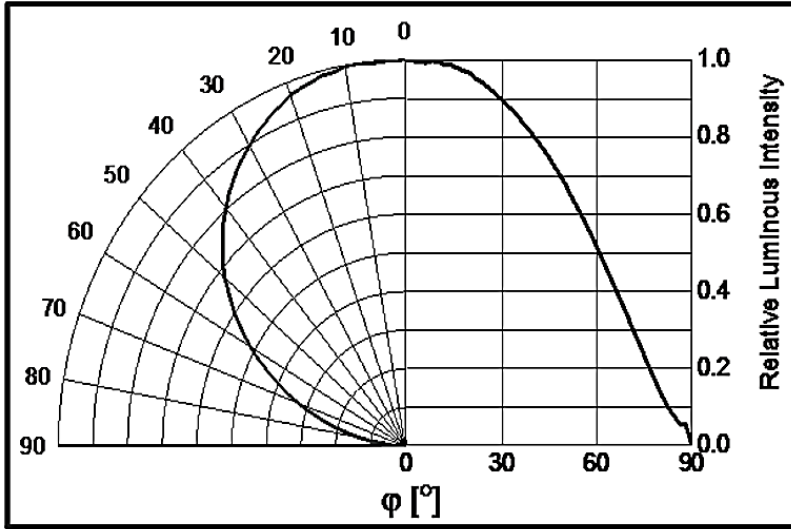

AUTOMOTIVE SMD TOP LED PLCC-2 3528 BDB-CW2MM SERIES

TAPE/REEL 2000pcs/Reel (Unit: mm)

- All Devices are packed in accordance with EIA standard RS-481-A
- Cumulative Tolerance : Cumulative Tolerance/10 pitches to be $\pm 0.2\text{mm}$
- Adhesion Strength of Cover Tape Adhesion strength to be 0.1-0.7N when the cover tape is turned off from the carrier tape at the angle of 10° to the carrier tape.
- Moisture Resistant Package

Tape

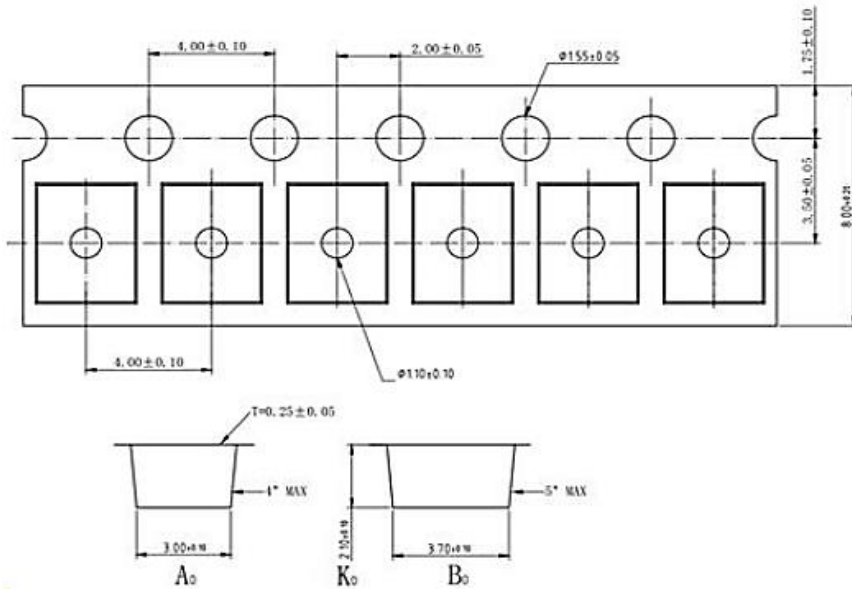

Reel

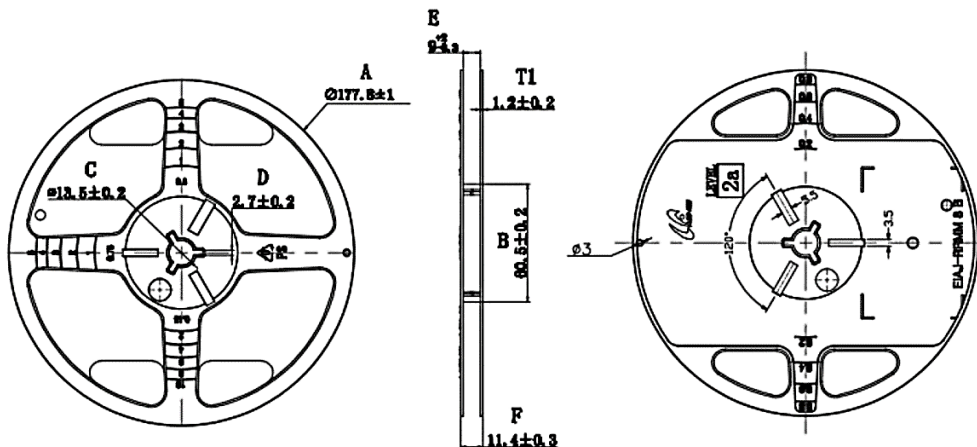

AUTOMOTIVE SMD TOP LED PLCC-2 3528 BDB-CW2MM SERIES

APPLICATION NOTES - Part I

- Storage: To avoid the moisture penetration, we recommend store in a dry box with a desiccant, The maximum storage temperature range is 40°C and a maximum humidity of RH60%.
- Use Precaution after Opening the Packaging: Recommend conditions after opening the package
 - a) Sealing b) Temperature : 30°C Humidity: Less than RH50% c) Recommend to use up before 72hrs after opening the package.
- If the package has been opened more than 4 weeks(MSL_2a) or the color desiccant changes, LED Components should be dried for 12hrs at 60±5°C. .
- Do not apply mechanical force or excess vibration during the cooling process to normal temperature after soldering.
- Do not rapidly cool device after soldering.
- The LED should not be mounted on warped portion of PCB.
- The LED should not be used in any type of fluid such as water, oil, organic solvent and etc. When washing is required, IPA (Isopropyl Alcohol) should be used.
- When the LEDs are in operation the maximum current should be decided after measuring the package temperature.
- Long time exposure of sunlight or occasional UV exposure will cause lens discoloration.
- The driving circuit must be designed to allow forward voltage only when it is ON or OFF. If the reverse voltage is applied to LED, migration can be generated resulting in LED damage.
- LEDs are sensitive to Electro-Static Discharge (ESD). Below is a list of suggestions that BND purposes to minimize these effects.
- The products are sensitive to static electricity or surge voltage. ESD can damage a die and it's Reliability. When handing the products, the following measures against electrostatic discharge are strongly recommended:
 - a) Increase in reverse leakage current lowered turn-on voltage
 - b) Abnormal emissions from the LED at low current LED

AUTOMOTIVE SMD TOP LED PLCC-2 3528 BDB-CW2MM SERIES

APPLICATION NOTES - Part II

The following recommendations are suggested to help minimize the potential for an ESD event.

- One or more recommended work area suggestions:
 - a) Dissipating static charge with conductive materials
 - b) Preventing charge generation with moisture
 - c) ESD safe storage containers ESD
- One or more personnel suggestion options:
 - a) Antistatic wrist-strap
 - b) Antistatic material shoes
 - c) Antistatic clothes
- Environmental controls: Humidity control (ESD gets worse in a dry environment)
- Handling Precautions: During processing, mechanical stress on the surface should be minimized as much as possible. Sharp objects of all types should not be used to pierce the sealing compound. In general, LEDs should only be handled from the side. By the way, this also applies to LEDs Without a silicone sealant, since the surface can also become scratched.
- NextGen suggests using isopropyl alcohol for cleaning. In case other solvents are used, it must be assured that these solvents do not dissolve the package or resin. Please do not mold this products into another resin (epoxy, urethane, etc.) and do not handle this Product with acid or sulfur material in sealed space.

AUTOMOTIVE SMD TOP LED PLCC-2 3528 BDB-CW2MM SERIES

APPLICATION NOTES - Part III

- The evaluation of eye safety occurs according to the standard IEC 62471:2006 (photo biological safety of lamps and lamp systems). Within the risk grouping system of this IEC standard, the device specified in this data sheet falls into the class exempt group (exposure time 10000 s). Under real circumstances (for exposure time, conditions of the eye pupils, observation distance), it is assumed that no endangerment to the eye exists from these devices. As a matter of principle, however, it should be mentioned that intense light sources have a high secondary exposure potential due to their blinding effect. When looking at bright light sources (e.g. headlights), temporary reduction in visual acuity and afterimages can occur, leading to irritation, annoyance, visual impairment, and even accidents, depending on the situation.
- Subcomponents of this device contain, in addition to other substances, metal plated materials including silver. Metal plated materials can be affected by environments that contain traces of aggressive substances. Therefore, we recommend that customers minimize device exposure to aggressive substances during storage, production, and use. Devices that showed visible discoloration when tested using the described tests above did show no performance deviations within failure limits during the stated test duration. Respective failure limits Notes are described in the IEC60810.

AUTOMOTIVE SMD TOP LED PLCC-2 3528 BDB-CW2MM SERIES

GLOSSARY

- **Brightness:** Brightness values are measured during a current pulse of typically 20ms, with an internal reproducibility of $\pm 5\%$.
- **Wavelength:** The wavelength is measured at a current pulse of typically 20ms, with an internal reproducibility of ± 1.5 nm.
- **Forward Voltage:** The forward voltage is measured during a current pulse of typically 20ms, with an internal reproducibility of ± 0.05 V.
- **Reverse Operation:** Continuous reverse operation is not allowed
- **Thermal Resistance:** RthJA results from mounting on PC board.
- **Typical Values:** Due to the special conditions of the manufacturing processes of semiconductor devices, the typical data or calculated correlations of technical parameters can only reflect statistical figures. These do not necessarily correspond to the actual parameters of each single product, which could differ from the typical data and calculated correlations or the typical characteristic line. If requested, e.g. because of technical improvements, these typ. data will be changed without any further notice.
- **Characteristic curve:** In the range where the line of the graph is broken, you must expect higher differences between single devices within one packing unit.

ROHS COMPLIANCE

- The levels of RoHS restricted materials in this product are below the maximum concentration values (also referred to as the threshold limits) permitted for such substances, or are used in an exempted application, in accordance with EU RoHS Directive (EU) 2015/863 EC (RoHS3). RoHS Test Report for this product can be obtained can be obtained at Download Center.

REACH COMPLIANCE

- REACH substances of high concern (SVHCs) information is available for this product. Since the European Chemical Agency (ECHA) has published notice of their intent to frequently revise the SVHC listing for the foreseeable future, REACH Test Report for this product can be obtained can be obtained at Download Center.

AUTOMOTIVE SMD TOP LED PLCC-2 3528 BDB-CW2MM SERIES

DISCLAIMER

- All Product parametric performance is indicated in the Electrical Characteristics for the listed herein test conditions, unless otherwise noted. Product performance may not be indicated by the Electrical Characteristics if operated under different conditions.
- NextGen Component, Inc (*NextGen*) reserves the right to make changes to this document and its products and specifications at any time without notice. Customers should obtain and confirm the latest product information and specifications before final design, purchase or use.
- *NextGen* makes no warranty, representation or guarantee regarding the suitability of its products for any particular purpose, nor does NextGen assume any liability for application assistance or customer product design.
- *NextGen* does not warrant or accept any liability with products which are purchased or used for any unintended or unauthorized application. No license is granted by implication or otherwise under any intellectual property rights of NextGen.
- *NextGen* products are not authorized for use as critical components in life support devices or systems without express written approval by *NextGen*.
- *NextGen* requires that customers first obtain an RMA (Returned Merchandise Authorization) number prior to returning any products. Returns must be made within 30 days of the date of invoice, be in the original packaging, unused and like-new condition. At the time of quoting or purchasing, a product may say that it is Non-Cancelable/ Non-Returnable (NCNR). These products are not returnable and not refundable.