

# MOSFET – Power, Complementary Dual ECH8

**60 V, 4.7 A, 55 mΩ**  
**-60 V, -3.5 A, 94 mΩ**

## ECH8690

### Description

This Power MOSFET is Produced Using onsemi’s Trench Technology, Which is Specifically Designed to Low on Resistance. This devices is suitable for applications with low on resistance requirements.

### Features

- On-State Resistance
  - ◆ Nch:  $R_{DS(on)1} = 42\text{ m}\Omega$  (typ.)
  - ◆ Pch:  $R_{DS(on)1} = 73\text{ m}\Omega$  (typ.)
- Protection Diode In
- 4 V rive
- Nch + Pch MOSFET
- This Device is Pb-Free, Halogen Free and RoHS Compliant

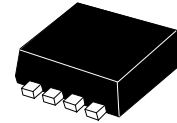

SOT-28FL/ECH8  
 CASE 318BF

### ELECTRICAL CONNECTION

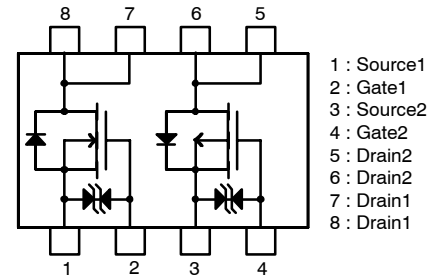

### MARKING DIAGRAM

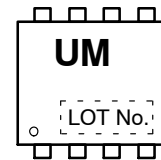

### ORDERING INFORMATION

See detailed ordering and shipping information on page 7 of this data sheet.

# ECH8690

## ABSOLUTE MAXIMUM RATINGS (T<sub>A</sub> = 25°C)

| Symbol           | Parameter                   | Conditions   | N-Channel   | P-Channel | Unit |
|------------------|-----------------------------|--|-------------|-----------|------|
| V <sub>DSS</sub> | Drain to Source Voltage     |  | 60          | -60       | V    |
| V <sub>GSS</sub> | Gate to Source Voltage      |  | ±20         | ±20       | V    |
| I <sub>D</sub>   | Drain Current (DC)          |  | 4.7         | -3.5      | A    |
| I <sub>DP</sub>  | Drain Current (Pulse)       | PW ≤ 10 μs, duty cycle ≤ 1%  | 30          | -30       | A    |
| P <sub>D</sub>   | Allowable Power Dissipation | When mounted on ceramic substrate (1200 mm <sup>2</sup> X 0.8 mm) 1 unit | 1.5         |           | W    |
| P <sub>T</sub>   | Total Dissipation           | When mounted on ceramic substrate (1200 mm <sup>2</sup> X 0.8 mm)        | 1.8         |           | W    |
| T <sub>ch</sub>  | Channel Temperature         |  | 150         |           | °C   |
| T <sub>stg</sub> | Storage Temperature         |  | -55 to +150 |           | °C   |

Stresses exceeding those listed in the Maximum Ratings table may damage the device. If any of these limits are exceeded, device functionality should not be assumed, damage may occur and reliability may be affected.

## ELECTRICAL CHARACTERISTICS (T<sub>A</sub> = 25°C) (Note 3)

| Symbol | Parameter | Conditions | Min | Typ | Max | Unit |
|--------|-----------|------------|-----|-----|-----|------|
|--------|-----------|------------|-----|-----|-----|------|

### [N-channel]

|                      |  |  |     |      |     |    |
|----------------------|--|--|-----|------|-----|----|
| V <sub>(BR)DSS</sub> | Drain to Source Breakdown Voltage          | I <sub>D</sub> = 1 mA, V <sub>GS</sub> = 0 V                           | 60  | -    | -   | V  |
| I <sub>DSS</sub>     | Zero-Gate Voltage Drain Current            | V <sub>DS</sub> = 60 V, V <sub>GS</sub> = 0 V                          | -   | -    | 1   | μA |
| I <sub>GSS</sub>     | Gate to Source Leakage Current             | V <sub>GS</sub> = ±16 V, V <sub>DS</sub> = 0 V                         |     | -    | ±10 | μA |
| V <sub>GS(off)</sub> | Cutoff Voltage                             | V <sub>DS</sub> = 10 V, I <sub>D</sub> = 1 mA                          | 1.2 | -    | 2.6 | V  |
| y <sub>fs</sub>      | Forward Transfer Admittance                | V <sub>DS</sub> = 10 V, I <sub>D</sub> = 2 A                           | -   | 4.2  | -   | S  |
| R <sub>DS(on)1</sub> | Static Drain to Source On-State Resistance | I <sub>D</sub> = 2 A, V <sub>GS</sub> = 10 V                           | -   | 42   | 55  | mΩ |
| R <sub>DS(on)2</sub> |  | I <sub>D</sub> = 1 A, V <sub>GS</sub> = 4.5 V                          | -   | 53   | 74  | mΩ |
| R <sub>DS(on)3</sub> |  | I <sub>D</sub> = 1 A, V <sub>GS</sub> = 4 V                            | -   | 61   | 85  | mΩ |
| C <sub>iss</sub>     | Input Capacitance                          | V <sub>DS</sub> = 20 V, f = 1 MHz                                      | -   | 955  | -   | pF |
| C <sub>oss</sub>     | Output Capacitance                         |  | -   | 58   | -   | pF |
| C <sub>rss</sub>     | Reverse Transfer Capacitance               |  | -   | 45   | -   | pF |
| t <sub>d(on)</sub>   | Turn-ON Delay Time                         | See specified Test Circuit.  | -   | 7    | -   | ns |
| t <sub>r</sub>       | Rise Time                                  |  | -   | 8.4  | -   | ns |
| t <sub>d(off)</sub>  | Turn-OFF Delay Time                        |  | -   | 76   | -   | ns |
| t <sub>f</sub>       | Fall Time                                  |  | -   | 23   | -   | ns |
| Q <sub>g</sub>       | Total Gate Charge                          | V <sub>DS</sub> = 30 V, V <sub>GS</sub> = 10 V, I <sub>D</sub> = 4.7 A | -   | 18   | -   | nC |
| Q <sub>gs</sub>      | Gate to Source Charge                      |  | -   | 3    | -   | nC |
| Q <sub>gd</sub>      | Gate to Drain "Miller" Charge              |  | -   | 2.8  | -   | nC |
| V <sub>SD</sub>      | Diode Forward Voltage                      | I <sub>S</sub> = 4.7 A, V <sub>GS</sub> = 0 V                          | -   | 0.82 | 1.2 | V  |

### [P-channel]

|                      |  |   |      |     |      |    |
|----------------------|--|---|------|-----|------|----|
| V <sub>(BR)DSS</sub> | Drain to Source Breakdown Voltage          | I <sub>D</sub> = -1 mA, V <sub>GS</sub> = 0 V     | -60  | -   | -    | V  |
| I <sub>DSS</sub>     | Zero-Gate Voltage Drain Current            | V <sub>DS</sub> = -60 V, V <sub>GS</sub> = 0 V    | -    | -   | -1   | μA |
| I <sub>GSS</sub>     | Gate to Source Leakage Current             | V <sub>GS</sub> = ±16 V, V <sub>DS</sub> = 0 V    |      | -   | ±10  | μA |
| V <sub>GS(off)</sub> | Cutoff Voltage                             | V <sub>DS</sub> = -10 V, I <sub>D</sub> = -1 mA   | -1.2 | -   | -2.6 | V  |
| y <sub>fs</sub>      | Forward Transfer Admittance                | V <sub>DS</sub> = -10 V, I <sub>D</sub> = -1.5 A  | -    | 3.4 | -    | S  |
| R <sub>DS(on)1</sub> | Static Drain to Source On-State Resistance | I <sub>D</sub> = -1 A, V <sub>GS</sub> = -10 V    | -    | 73  | 94   | mΩ |
| R <sub>DS(on)2</sub> |  | I <sub>D</sub> = -0.5 A, V <sub>GS</sub> = -4.5 V | -    | 97  | 135  | mΩ |
| R <sub>DS(on)3</sub> |  | I <sub>D</sub> = -0.5 A, V <sub>GS</sub> = 4 V    | -    | 108 | 153  | mΩ |

# ECH8690

## ELECTRICAL CHARACTERISTICS ( $T_A = 25^\circ\text{C}$ ) (Note 3) (continued)

| Symbol              | Parameter                     | Conditions                                 | Min   | Typ   | Max  | Unit |
|---------------------|-------------------------------|--|---|-------|------|------|
| <b>[P-channel]</b>  |                               |  |   |       |      |      |
| C <sub>iss</sub>    | Input Capacitance             | $V_{DS} = -20\text{ V}, f = 1\text{ MHz}$  | -   | 790   | -    | pF   |
| C <sub>oss</sub>    | Output Capacitance            |  | -   | 63    | -    | pF   |
| C <sub>rss</sub>    | Reverse Transfer Capacitance  |  | -   | 45    | -    | pF   |
| t <sub>d(on)</sub>  | Turn-ON Delay Time            | See specified Test Circuit.                | -   | 10    | -    | ns   |
| t <sub>r</sub>      | Rise Time                     |  | -   | 8.8   | -    | ns   |
| t <sub>d(off)</sub> | Turn-OFF Delay Time           |  | -   | 84    | -    | ns   |
| t <sub>f</sub>      | Fall Time                     |  | -   | 29    | -    | ns   |
| Q <sub>g</sub>      | Total Gate Charge             |  | $V_{DS} = -30\text{ V}, V_{GS} = -10\text{ V}, I_D = -3.5\text{ A}$ | -     | 15   | -    |
| Q <sub>gs</sub>     | Gate to Source Charge         | -  |   | 2.6   | -    | nC   |
| Q <sub>gd</sub>     | Gate to Drain "Miller" Charge | -  |   | 2.2   | -    | nC   |
| V <sub>SD</sub>     | Diode Forward Voltage         | $I_S = -3.5\text{ A}, V_{GS} = 0\text{ V}$ | -   | -0.83 | -1.2 | V    |

Product parametric performance is indicated in the Electrical Characteristics for the listed test conditions, unless otherwise noted. Product performance may not be indicated by the Electrical Characteristics if operated under different conditions.

**[N-Channel]**

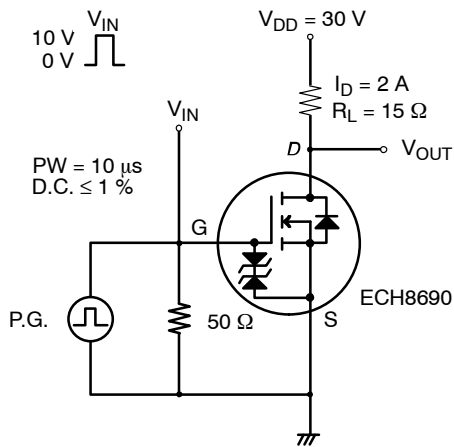

**[P-Channel]**

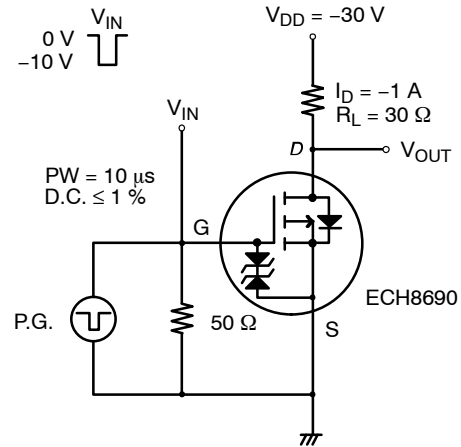

**Figure 1. Switching Time Test Circuit**

TYPICAL CHARACTERISTICS

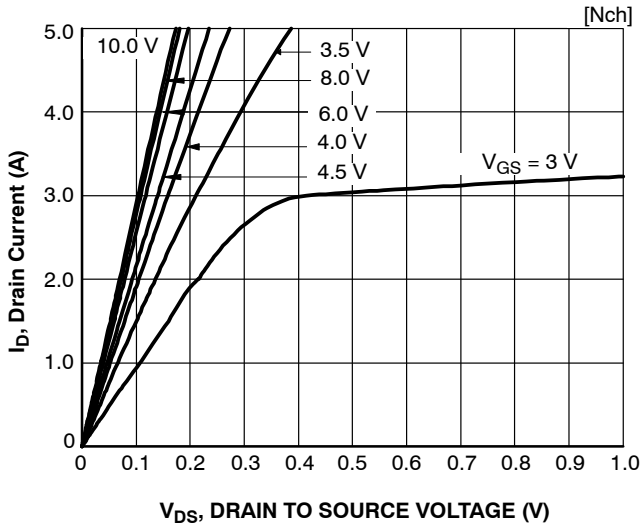

Figure 2.  $I_D - V_{DS}$

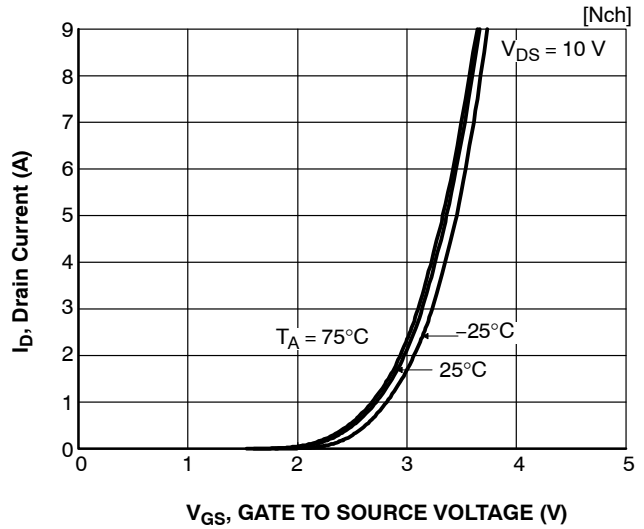

Figure 3.  $I_D - V_{GS}$

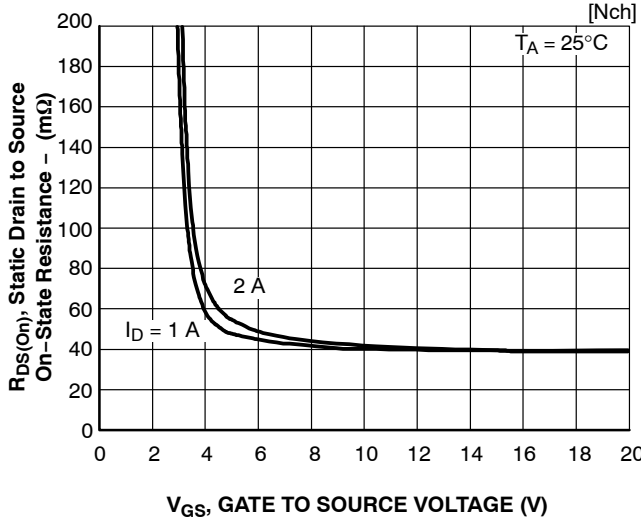

Figure 4.  $R_{DS(on)} - V_{GS}$

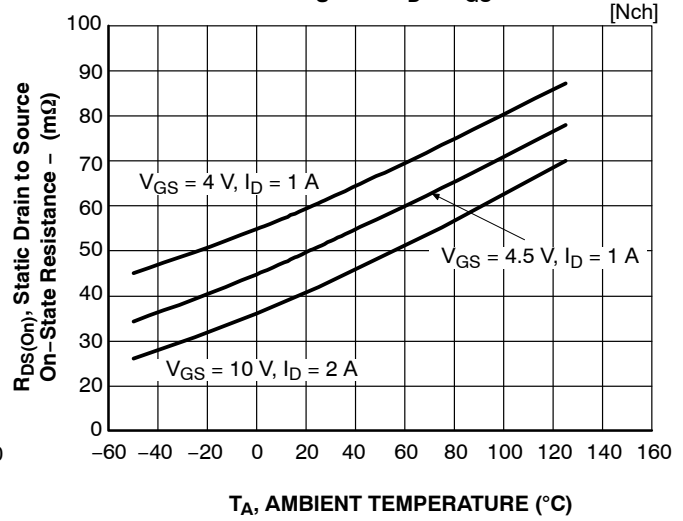

Figure 5.  $R_{DS(on)} - T_A$

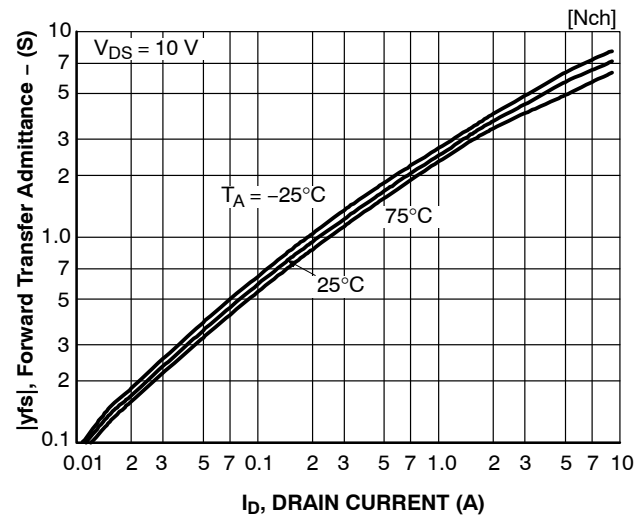

Figure 6.  $|Y_{fs}| - I_D$

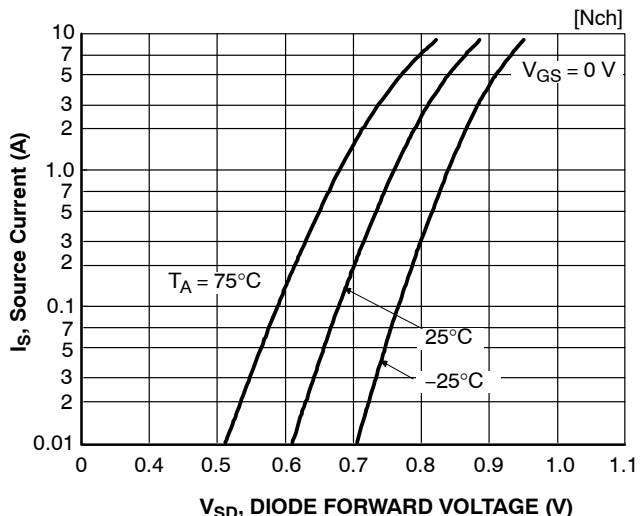

Figure 7.  $I_S - V_{SD}$

TYPICAL CHARACTERISTICS (CONTINUED)

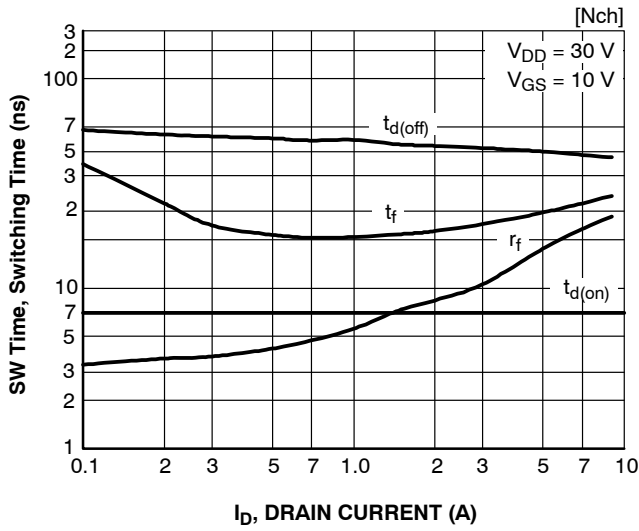

Figure 8.  $I_D$  - S/W Time

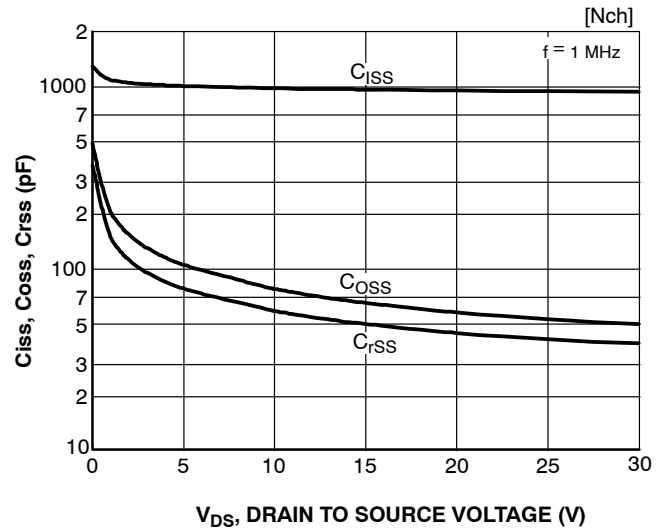

Figure 9. Ciss, Coss, Crss -  $V_{DS}$

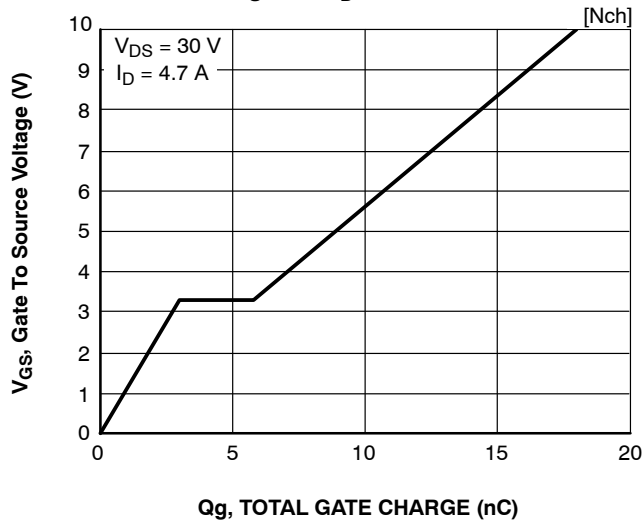

Figure 10.  $V_{GS}$  -  $Q_g$

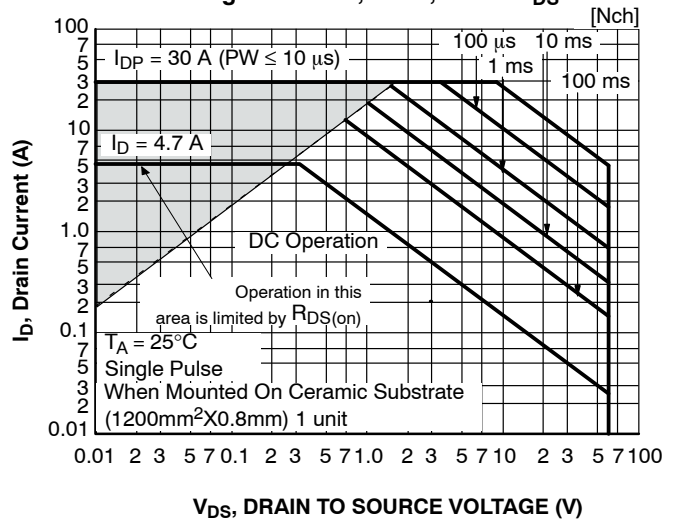

Figure 11. S O A

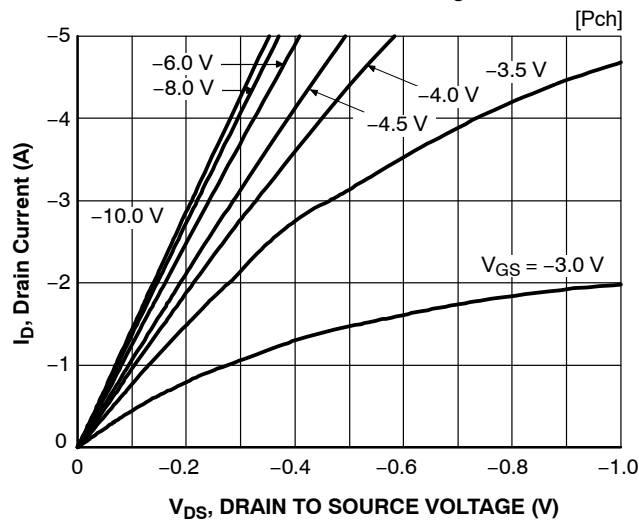

Figure 12.  $I_D$  -  $V_{DS}$

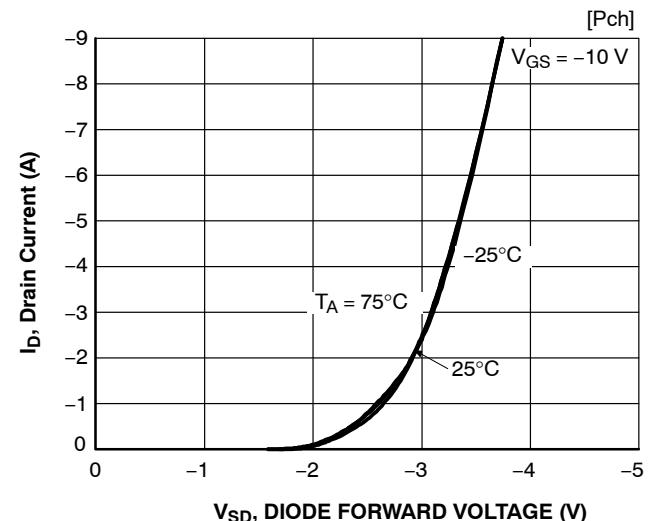
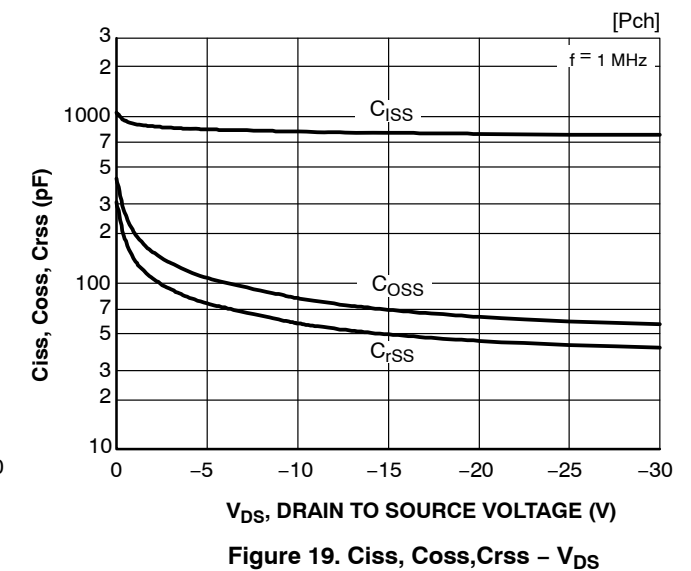
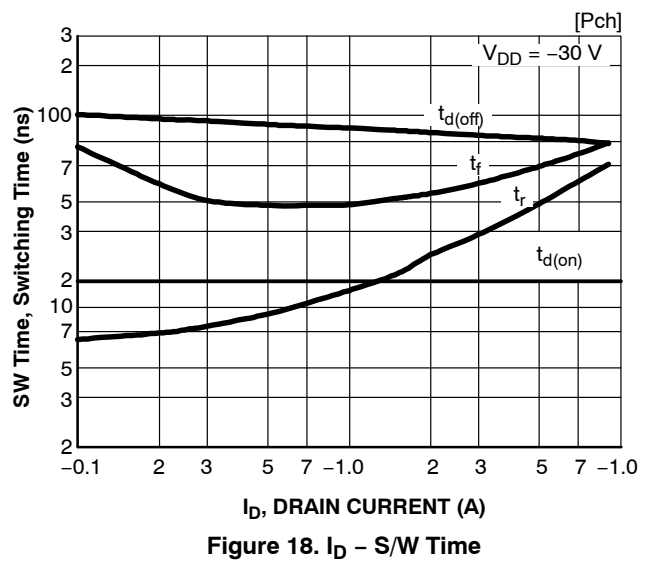
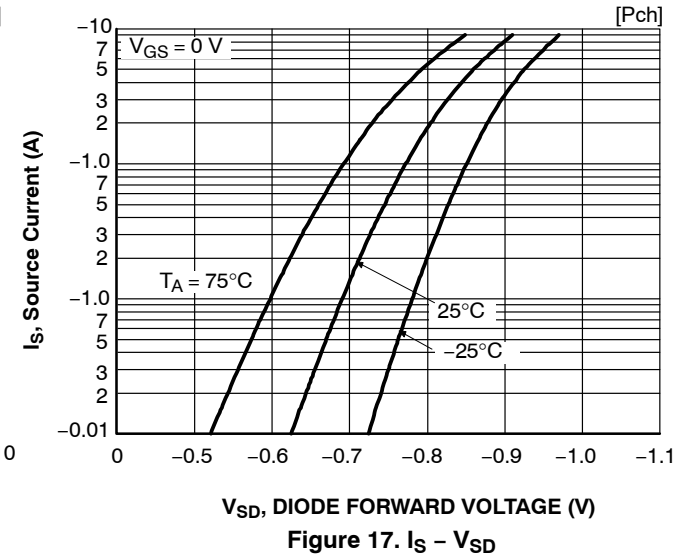
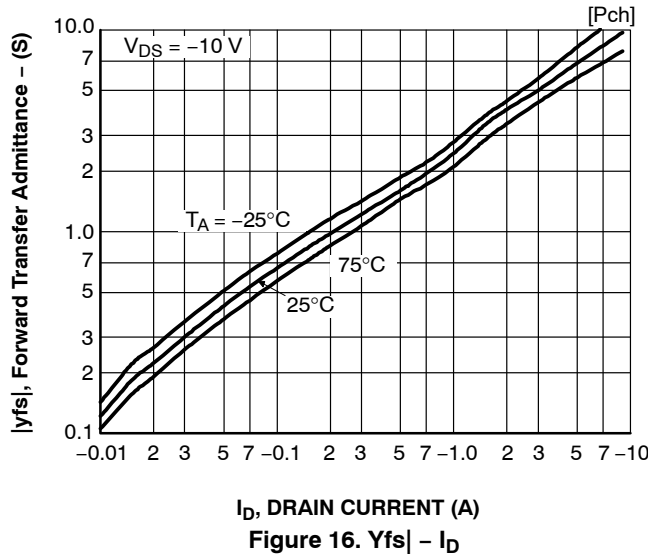
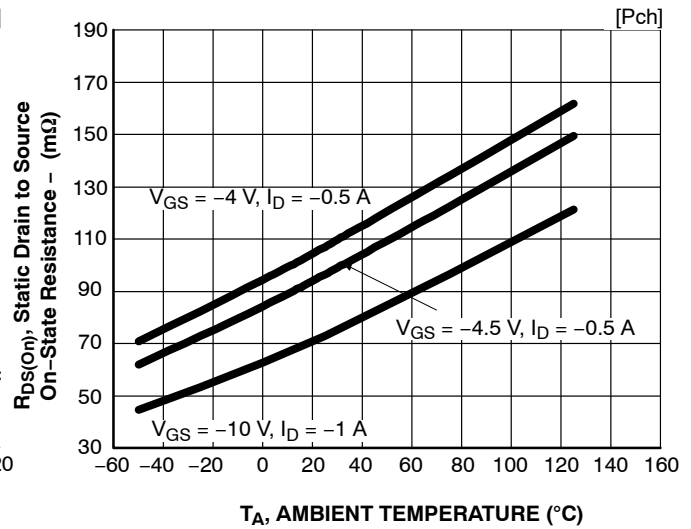
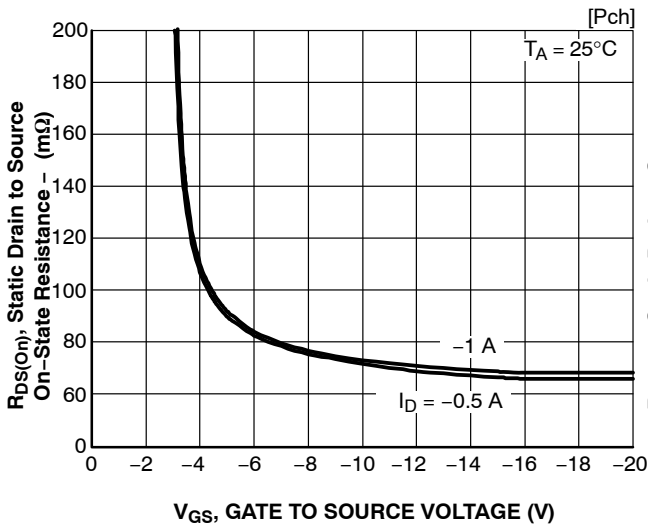

Figure 13.  $I_D$  -  $V_{GS}$

TYPICAL CHARACTERISTICS (CONTINUED)



TYPICAL CHARACTERISTICS (CONTINUED)

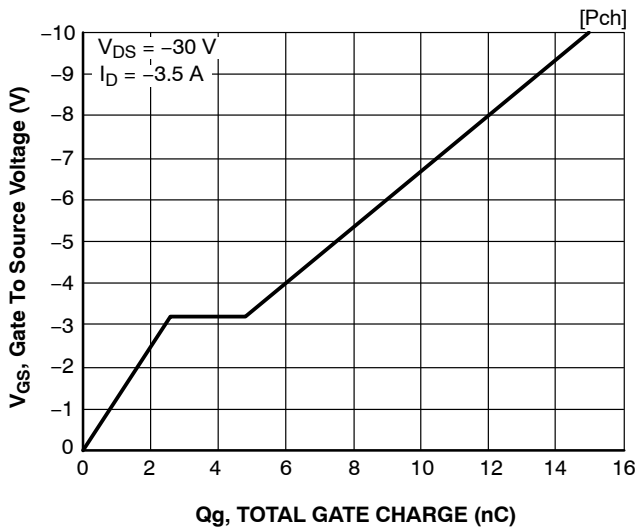

Figure 20.  $V_{GS} - Q_g$

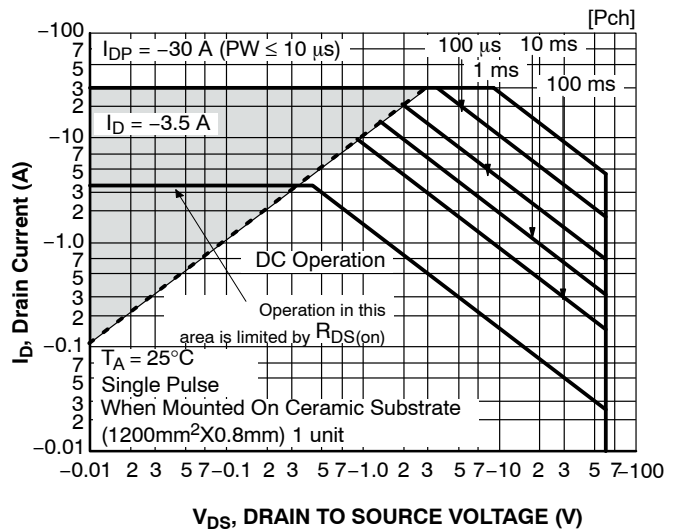

Figure 21. S O A

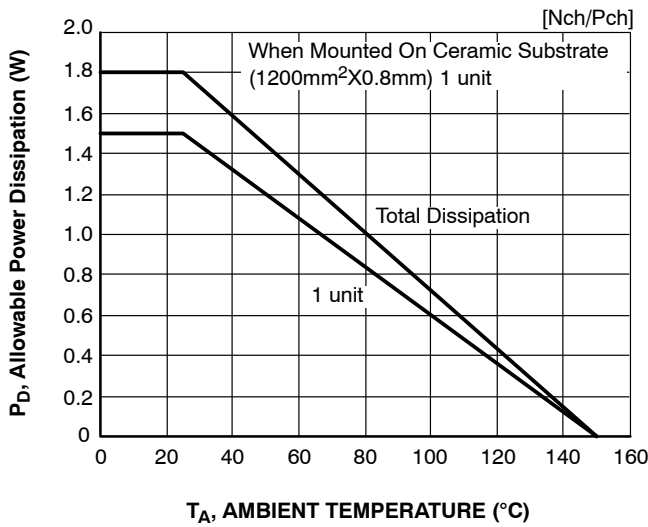

Figure 22.  $P_D - T_A$

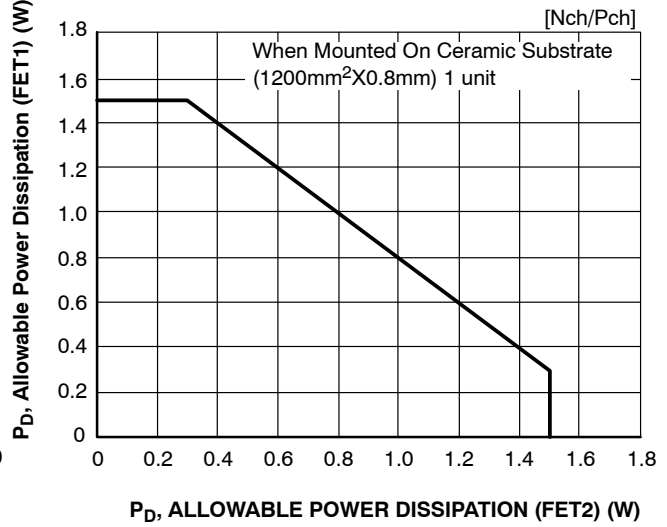

Figure 23.  $P_D$  (FET1) -  $P_D$  (FET2)

ORDERING INFORMATION

| Product Number | Package                                     | Shipping†            |
|----------------|---|----------------------|
| ECH8690-TL-H   | SOT-28FL / ECH8<br>(Pb-Free / Halogen Free) | 3000 / Tape and Reel |

†For information on tape and reel specifications, including part orientation and tape sizes, please refer to our Tape and Reel Packaging Specifications Brochure, [BRD8011/D](#).

Note on usage : Since the ECH8690 is a MOSFET product, please avoid using this device in the vicinity of highly charged objects. Please contact sales for use except the designated application.

**MECHANICAL CASE OUTLINE**  
**PACKAGE DIMENSIONS**

**SOT-28FL / ECH8**  
**CASE 318BF**  
**ISSUE O**

DATE 31 MAR 2012

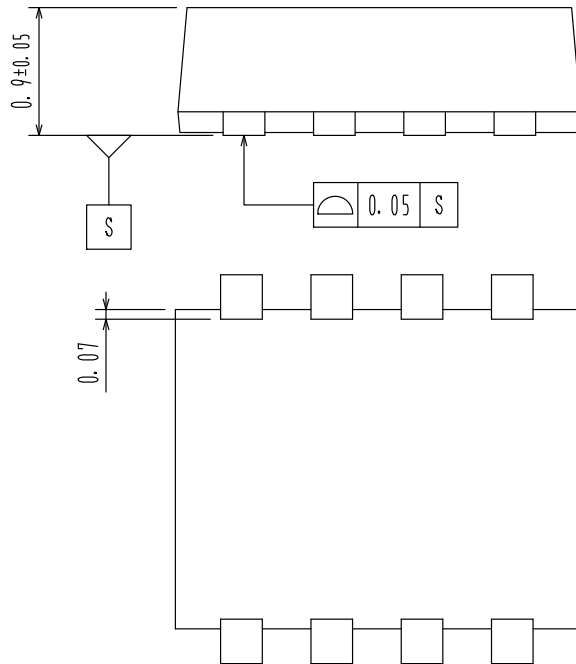
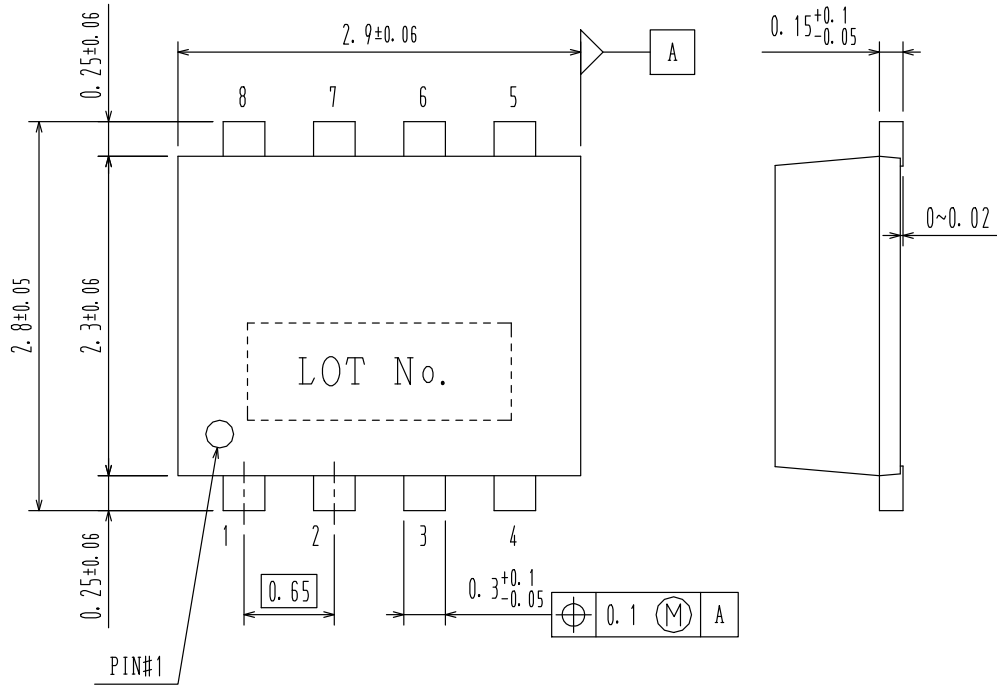

|                         |                        |   |
|-------------------------|------------------------|---|
| <b>DOCUMENT NUMBER:</b> | <b>98AON78700E</b>     | Electronic versions are uncontrolled except when accessed directly from the Document Repository.<br>Printed versions are uncontrolled except when stamped "CONTROLLED COPY" in red. |
| <b>DESCRIPTION:</b>     | <b>SOT-28FL / ECH8</b> | <b>PAGE 1 OF 1</b>  |

ON Semiconductor and are trademarks of Semiconductor Components Industries, LLC dba ON Semiconductor or its subsidiaries in the United States and/or other countries. ON Semiconductor reserves the right to make changes without further notice to any products herein. ON Semiconductor makes no warranty, representation or guarantee regarding the suitability of its products for any particular purpose, nor does ON Semiconductor assume any liability arising out of the application or use of any product or circuit, and specifically disclaims any and all liability, including without limitation special, consequential or incidental damages. ON Semiconductor does not convey any license under its patent rights nor the rights of others.



**onsemi**, **Onsemi**, and other names, marks, and brands are registered and/or common law trademarks of Semiconductor Components Industries, LLC dba "**onsemi**" or its affiliates and/or subsidiaries in the United States and/or other countries. **onsemi** owns the rights to a number of patents, trademarks, copyrights, trade secrets, and other intellectual property. A listing of **onsemi**'s product/patent coverage may be accessed at [www.onsemi.com/site/pdf/Patent-Marking.pdf](http://www.onsemi.com/site/pdf/Patent-Marking.pdf). **onsemi** reserves the right to make changes at any time to any products or information herein, without notice. The information herein is provided "as-is" and **onsemi** makes no warranty, representation or guarantee regarding the accuracy of the information, product features, availability, functionality, or suitability of its products for any particular purpose, nor does **onsemi** assume any liability arising out of the application or use of any product or circuit, and specifically disclaims any and all liability, including without limitation special, consequential or incidental damages. Buyer is responsible for its products and applications using **onsemi** products, including compliance with all laws, regulations and safety requirements or standards, regardless of any support or applications information provided by **onsemi**. "Typical" parameters which may be provided in **onsemi** data sheets and/or specifications can and do vary in different applications and actual performance may vary over time. All operating parameters, including "Typicals" must be validated for each customer application by customer's technical experts. **onsemi** does not convey any license under any of its intellectual property rights nor the rights of others. **onsemi** products are not designed, intended, or authorized for use as a critical component in life support systems or any FDA Class 3 medical devices or medical devices with a same or similar classification in a foreign jurisdiction or any devices intended for implantation in the human body. Should Buyer purchase or use **onsemi** products for any such unintended or unauthorized application, Buyer shall indemnify and hold **onsemi** and its officers, employees, subsidiaries, affiliates, and distributors harmless against all claims, costs, damages, and expenses, and reasonable attorney fees arising out of, directly or indirectly, any claim of personal injury or death associated with such unintended or unauthorized use, even if such claim alleges that **onsemi** was negligent regarding the design or manufacture of the part. **onsemi** is an Equal Opportunity/Affirmative Action Employer. This literature is subject to all applicable copyright laws and is not for resale in any manner.

## ADDITIONAL INFORMATION

### TECHNICAL PUBLICATIONS:

Technical Library: [www.onsemi.com/design/resources/technical-documentation](http://www.onsemi.com/design/resources/technical-documentation)  
onsemi Website: [www.onsemi.com](http://www.onsemi.com)

### ONLINE SUPPORT: [www.onsemi.com/support](http://www.onsemi.com/support)

For additional information, please contact your local Sales Representative at [www.onsemi.com/support/sales](http://www.onsemi.com/support/sales)