

ASDL-4263

High Efficiency T-1 3/4 (5mm) Infrared (940nm) Lamp



Data Sheet

Description

ASDL-4263 is a Infrared emitter that is optimized for high efficiency at emission wavelength of 940nm and narrow viewing angle. This device is designed for high radiant intensity and low forward voltage applications. It is encapsulated in T1-3/4 (5mm) package and is suitable for high performance replacements of standard emitters.

Applications

- Smoke Detector
- IR Remote Control for Consumer Devices
- IR Remote Control for Industrial Equipment
- Photo-interrupters
- Reflective Applications
- Infrared Illuminator Security Camera

Features

- T 1- 3/4 Package
- 940nm Wavelength
- Narrow Viewing Angle
- High Brightness
- Low Forward Voltage
- Paired Device to ASDL-5770 and ASDL-5771
- Design for Smoke Detector & Fire Alarm Application
- Lead Free & ROHS Compliant
- Available in Tape & Reel

Ordering Information

Part Number	Lead Form	Color	Packaging	Shipping Option
ASDL-4263-C22	Straight	Clear	Tape & Reel	2000pcs
ASDL-4263-C31			Bulk	8000pcs / Carton

Absolute Maximum Ratings at 25°C

Parameter	Symbol	Min.	Max	Unit	Reference
Peak Forward Current	I_{FPK}		3	A	300pps
DC Forward Current	I_{FDC}		50	mA	
Power Dissipation	P_{DISS}		100	mW	
Reverse Voltage	V_R		5	V	
Operating Temperature	T_O	-40	85	°C	
Storage Temperature	T_S	-55	100	°C	
LED Junction Temperature	T_J		110	°C	
Lead Soldering Temperature [1.6mm (0.063") From Body]	260°C for 5 seconds				

Electrical Characteristics at 25°C

Parameter	Symbol	Min.	Typ.	Max.	Unit	Condition
Forward Voltage	V_F		1.2	1.6	V	$I_F=20mA$
Reverse Voltage	V_R	5			V	$I_R=100\mu A$
Thermal Resistance, Junction to Ambient	$R_{\theta ja}$		250		°C/W	

Optical Characteristics at 25°C

Parameter	Symbol	Min.	Typ.	Max.	Unit	Condition	Bin
Radiant On-Axis Intensity	I_E	9.72		19.08	mW/Sr	$I_F=20mA$	Bin A
		12.72		23.58			Bin B
		15.72					Bin C
Viewing Angle	$2\theta_{1/2}$		20		deg		
Peak wavelength	λ_{PK}		940		nm	$I_{FDC} = 20mA$	
Spectral Width	$\Delta\lambda$		50		nm	$I_{FDC} = 20mA$	
Optical Rise Time	t_r		1		us	$I_{FPK}=100mA$ Duty Factor=50% Pulse Width=10us	
Optical Fall Time	t_f		1		us	$I_{FPK}=100mA$ Duty Factor=50% Pulse Width=10us	

Package Dimension

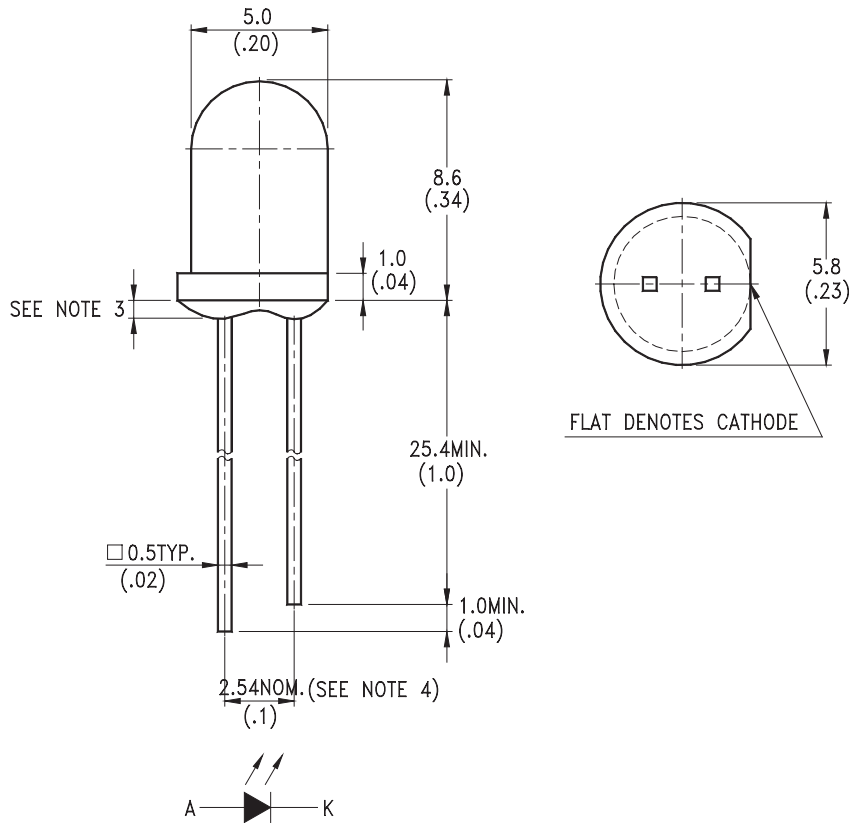

Notes:

1. All dimensions are in millimeters (inches)
2. Tolerance is + 0.25mm (.010") unless otherwise noted
3. Protuded resin under flange is 1.0mm (.039") max
4. Lead spacing is measured where leads emerge from package
5. Specifications are subject to change without notice

Typical Electrical / Optical Characteristics
 ($T_A = 25^\circ\text{C}$ Unless Otherwise Indicated)

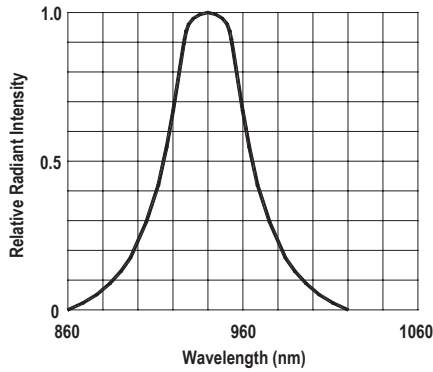

Figure 1. Spectral Distribution

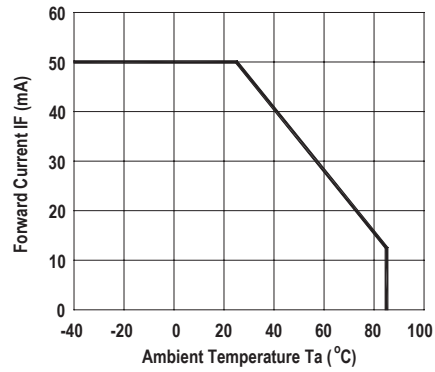

Figure 2. Forward Current Vs. Ambient Temperature

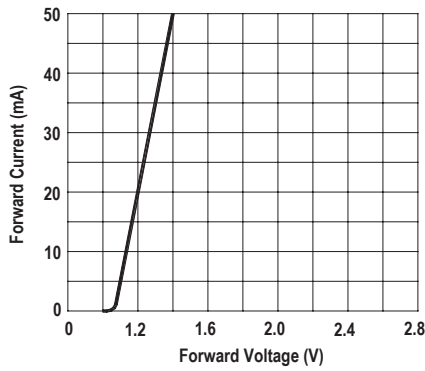

Figure 3. Forward Current Vs. Forward Voltage

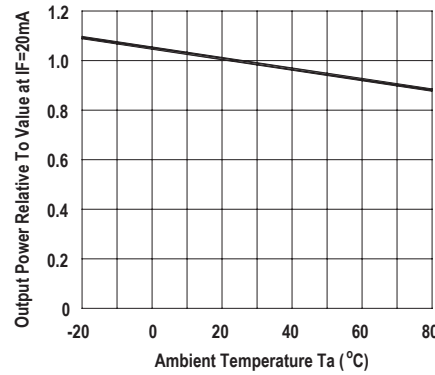

Figure 4. Relative Radiant Intensity Vs. Ambient Temperature

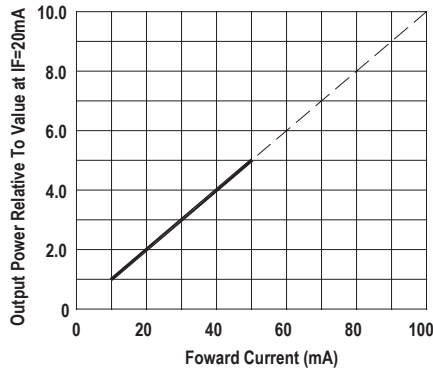

Figure 5. Relative Radiant Intensity Vs. Forward Current

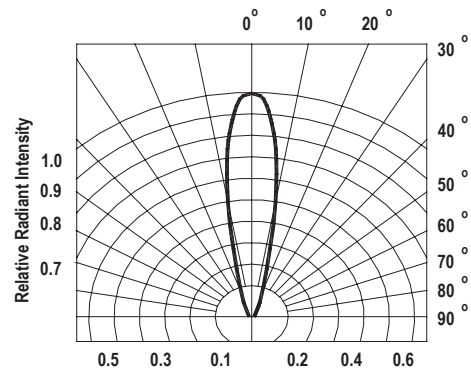

Figure 6. Radiation Diagram

For company and product information, please go to our web site: WWW.liteon.com or <http://optodatabook.liteon.com/databook/databook.aspx>

Data subject to change. Copyright © 2007 Lite-On Technology Corporation. All rights reserved.

