

# A48

## 2MP Face, People and Car Detection Zoom Bullet with D/N, Adaptive IR, Extreme WDR, ELLS, 10x Zoom Lens



- Face, People and Car Detection
- 2 Megapixel
- Day & Night with Extreme Low Light Sensitivity and Adaptive IR LED
- 10x Zoom Lens with f4.7-47mm/F1.6-F3.0, DC iris, Auto focus (for installation)
- Extreme WDR
- H.265 Compression
- Built-in Analytics
- Event trigger, response and notification

### ► Specifications

#### Device

|                          |  |
|--------------------------|--|
| Product Type             | Zoom Bullet  |
| Maximum Resolution       | 2MP  |
| Product Application      | Face, People and Car Detection   |
| Application Environment  | Outdoor  |
| Image Sensor             | Progressive Scan CMOS  |
| Sensor Size              | 1/2.8 "  |
| Effective Pixels         | 1945(H) X 1097(V) (2.13 MP)  |
| Day / Night              | Yes  |
| Low Light Sensitivity    | Extreme  |
| Minimum Illumination     | Color: 0.002 lux at F1.4; B/W: 0.001 lux at F1.4; B/W: 0 lux (IR LED on) |
| Color to B/W Switch      | ISP based switch, configurable   |
| Mechanical IR Cut Filter | Yes  |
| IR LED                   | Adaptive IR LED  |
| IR Working Distance      | 30m  |
| Electronic Shutter       | 1/5-1/64000 second (manual mode); 1/5-1/64000 second (auto mode)         |

Horizontal Resolution (TV Lines) | 1300 TVL

**Lens**

|                          |                     |
|--------------------------|---------------------|
| Focal Length             | Zoom, f4.7-47mm     |
| Aperture                 | F1.6-F3.0           |
| Zoom Ratio               | 10x optical zoom    |
| Zoom Application         | Camera Installation |
| Iris                     | DC iris             |
| Focus                    | Auto focus          |
| Horizontal Viewing Angle | 58.7° - 6.2°        |
| Vertical Viewing Angle   | 40° - 4°            |

**Video**

|                                      |   |
|--------------------------------------|---|
| Compression                          | H.265, H.264 (Baseline/ Main/ High profile), MJPEG  |
| Maximum Frame Rate vs. Resolution    | 30 fps at 1920 x 1080 30 fps at 1280 x 960 30 fps at 1280 x 720 30 fps at 800 x 600 30 fps at 720 x 480 30 fps at 640 x 480 30 fps at 320 x 240   |
| Multi-Streaming                      | Simultaneous quad streams based on configurations of video resolution, compression format, and frame rate   |
| Bit Rate                             | 128Kbps - 12Mbps (per stream)   |
| Bit Rate Mode                        | Constant, Variable  |
| Wide Dynamic Range                   | Extreme WDR (142 dB)  |
| Image Enhancement                    | White Balance, Brightness, Contrast, Saturation, Sharpness, Automatic gain control, Flickerless, Backlight compensation (BLC), Strong Light Suppression, Digital Image Stabilizer (DIS, EIS), Defogging |
| Digital Noise Reduction              | 2D + 3D DNR   |
| Privacy Mask                         | Yes, 4 configurable regions   |
| Text Overlay                         | Yes   |
| On-Screen Graphics (Picture Overlay) | Yes   |
| Built-in Analytics                   | People Detection, Vehicle Detection, Face Detection (* To be available through future firmware upgrade), Tampering Detection  |
| Image Orientation                    | Flip, Mirror, Rotation (Corridor mode) (90°, 180°, 270°)  |

**Audio**

|                   |                                  |
|-------------------|----------------------------------|
| Audio Type        | 2-way, Mic-in, Line-in, Line-out |
| Audio Compression | G.711 u-law                      |

**Network**

|                            |   |
|----------------------------|---|
| Network Protocol & Service | IPv4/v6, TCP, UDP, DHCP, PPPoE, HTTP, HTTPS, DNS, DDNS, NTP, RTP, RTSP, RTCP, SMTP, FTP, IGMP, ICMP, ARP, Bonjour, UPnP, QoS, SNMP, IEEE 802.1X |
| Ethernet Port              | 1 x Ethernet (10/100 Base-T), RJ-45 pigtail connector   |
| Security                   | IP address filtering, HTTPS encryption, Password protected user level, Anonymous login, IEEE 802.1X network access control                      |

**Video Analytics**

|                      |          |
|----------------------|----------|
| Analysis Source Type | Video    |
| Metadata Accuracy    | Standard |

**Event**

|                |   |
|----------------|---|
| Event Trigger  | Video motion detection (3 regions), External device through digital input, Sound detection, Intelligent event detection, Video streams loss   |
| Event Response | Notify control center, Change camera settings, Command other devices, E-mail notification with snapshots, Play the audio file, Push notification to mobile device, Save video to local storage, Upload video to NVR server, Upload video or snapshot to FTP server, Activate external device through digital output |

**Integration**

|                          |   |
|--------------------------|---|
| Unified Solution         | Fully compatible with ACTi software             |
| Software Development Kit | Yes   |
| GPS Position             | Manual setting                                  |
| ONVIF Compliant          | Yes, Profile S, Profile G, Profile T, Profile Q |
| Web Browser              | IE 11   |
| Auto Firmware Upgrade    | Yes   |

**Interface**

|                      |  |
|----------------------|--|
| Audio Interface      | 1/1, Cable with 3.5mm Phone Jack   |
| Analog Video Output  | 1 x CVBS, BNC connector, for installation only   |
| Local Storage        | MicroSDHC, MicroSDXC Memory Card Slot (card not included, up to 256GB, Kingston or Sandisk only) |
| Digital Input/Output | 1/1 (Cable with Terminal block), DC Output Voltage: 5V   |
| Operating Button     | Reset Button   |

**General**

|                       |  |
|-----------------------|--|
| Power Source          | DC 12V, PoE Class 3 (IEEE802.3af)  |
| Power Consumption     | 12.95 W (PoE)  |
| Weight                | 1270g (2.80lb)   |
| Dimensions            | (W x H x D): 94mm x 86mm x 291.1mm (3.7" x 3.38" x 11.46")   |
| Environmental Casing  | Weatherproof (IP67), Vandal proof metal casing (IK10)  |
| Bundled Accessories   | Integrated bracket   |
| Starting Temperature  | -20°C ~ 50°C (-4°F ~ 122°F)  |
| Operating Temperature | -40°C ~ 50°C (-40°F ~ 122°F)   |
| Operating Humidity    | 20% - 80% RH   |
| Approvals             | CE Class A, FCC Class A, EAC, IP67, IK10 (metal casing)  |
| Real-time Clock (RTC) | Yes  |
| Warranty              | 3 Year(s). For extended warranty offering, see <a href="http://www.acti.com/support/warranty">http://www.acti.com/support/warranty</a> |

## ► Photo Indication



- 1 Audio Output
- 2 DC 12V Power Input
- 3 Factory Reset
- 4 BNC Video Output
- 5 Audio Input
- 6 Ethernet Port
- 7 Digital Input / Output



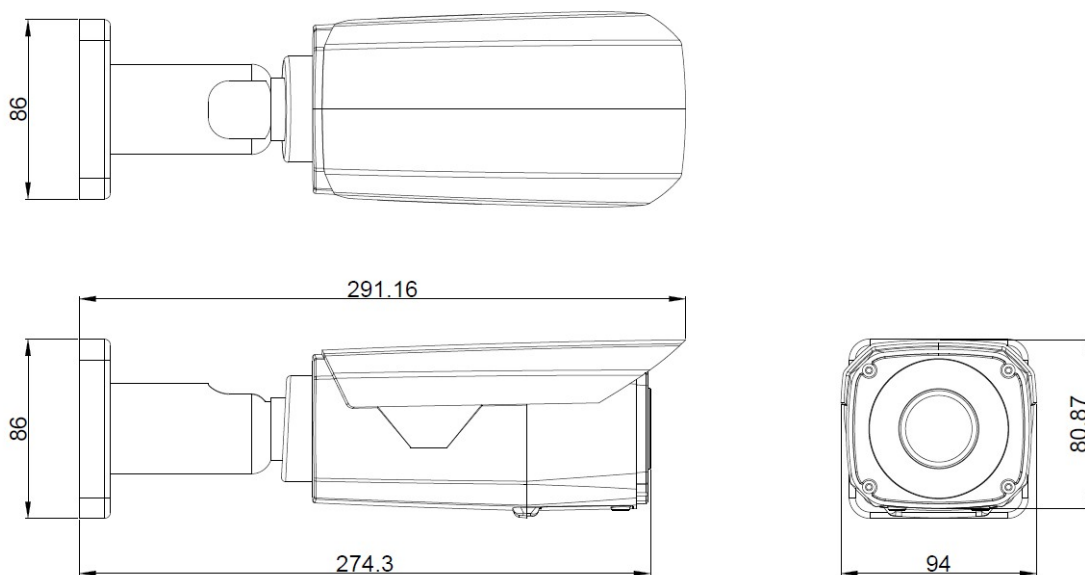

## ► Dimension Diagram



Unit: mm [inch]



## ▶ Related Products

### Mounting Accessories - Camera Mount

|           |   |  |
|-----------|---|--|
| PMAX-0512 |  | Pole Mount (for E39, PMAX-0706), supports 3.25" to 7.0" Poles  |
| PMAX-0517 |  | Pole Mount (for A44, A45, A46, A48, A413), supports 3.25" to 7.0" Poles                              |
| PMAX-0518 |  | Pole Mount (for A44, A45, A46, A48, A413), supports 2" to 3" Poles                                   |
| PMAX-0524 |  | Pole Mount (for A416, A418, A419, A44, A45, A46, A48, VMGB-351, B419-P2), supports 2.64" to 5" Poles |
| PMAX-0706 |  | Junction Box (for A3x, A4x, E39, E41x, PMAX-0805)  |

**Note:** Some mounting accessories may need additional accessories for installation. Please check [www.acti.com/mountingselector](http://www.acti.com/mountingselector) for more information.

### Audio Devices - Microphone

|           |  |   |
|-----------|--|---|
| PMIC-0100 |   | Active Microphone Omnidirectional for all Cameras with Line-in Audio                        |
| PMIC-0200 |  | Passive Microphone Omnidirectional for all Cameras with Mic-in Audio using 3.5mm Phone Jack |

