

MOSFET – N-Channel, POWERTRENCH[®], SyncFET™

FDS8672S

General Description

The FDS8672S is designed to replace a single MOSFET and Schottky diode in synchronous DC/DC power supplies. This 30 V MOSFET is designed to maximize power conversion efficiency, providing a low $R_{DS(on)}$ and low gate charge. The FDS8672S includes a patented combination of a MOSFET monolithically integrated with a Schottky diode using ON Semiconductor's monolithic SyncFET technology.

Features

- Max $R_{DS(on)}$ = 4.8 m Ω at V_{GS} = 10 V, I_D = 18 A
- Max $R_{DS(on)}$ = 7.0 m Ω at V_{GS} = 4.5 V, I_D = 15 A
- Includes SyncFET Schottky Body Diode
- High Performance Trench Technology for Extremely Low $R_{DS(on)}$ and Fast Switching
- High Power and Current Handling Capability
- 100% R_g (Gate Resistance) Tested
- This Device is Pb-Free, Halogen Free/BFR Free and is RoHS Compliant

Applications

- Notebook Vcore Low Side Switch
- Synchronous Rectifier for DC/DC Converters
- Point of Load Low Side Switch



ON Semiconductor[®]

www.onsemi.com

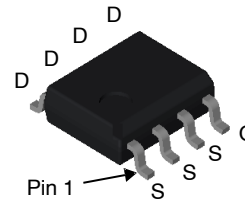

**SOIC8
CASE 751EB**

MARKING DIAGRAM

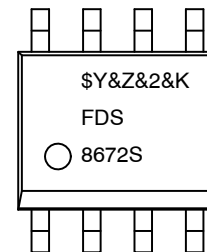

&Y = ON Semiconductor Logo
 &Z = Assembly Plant Code
 &2 = Numeric Date Code
 &K = Lot Code
 FDS8672S = Specific Device Code

PIN CONFIGURATION

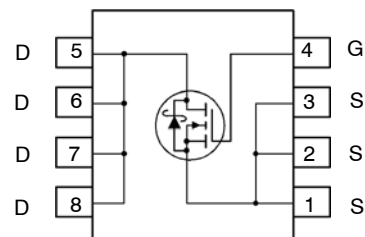

ORDERING INFORMATION

See detailed ordering and shipping information on page 3 of this data sheet.

FDS8672S

MOSFET MAXIMUM RATINGS ($T_A = 25^\circ\text{C}$ Unless Otherwise Noted)

Symbol	Parameter	Ratings	Unit
V_{DS}	Drain to Source Voltage	30	V
V_{GS}	Gate to Source Voltage	± 20	V
I_D	Drain Current –Continuous	18	A
	Drain Current –Pulsed (Note 4)	80	
E_{AS}	Single Pulse Avalanche Energy (Note 3)	216	mJ
P_D	Power Dissipation $T_A = 25^\circ\text{C}$ (Note 1a)	2.5	W
	Power Dissipation $T_A = 25^\circ\text{C}$ (Note 1b)	1.0	
T_J, T_{STG}	Operating and Storage Junction Temperature Range	-55 to $+150$	$^\circ\text{C}$

Stresses exceeding those listed in the Maximum Ratings table may damage the device. If any of these limits are exceeded, device functionality should not be assumed, damage may occur and reliability may be affected.

THERMAL CHARACTERISTICS

Symbol	Parameter	Ratings	Unit
$R_{\theta JC}$	Thermal Resistance, Junction to Case (Note 1)	25	$^\circ\text{C}/\text{W}$
$R_{\theta JA}$	Thermal Resistance, Junction to Ambient (Note 1a)	50	

ELECTRICAL CHARACTERISTICS ($T_J = 25^\circ\text{C}$ Unless Otherwise Noted)

Symbol	Parameter	Test Conditions	Min	Typ	Max	Unit
--------	-----------	-----------------	-----	-----	-----	------

OFF CHARACTERISTICS

BV_{DSS}	Drain to Source Breakdown Voltage	$I_D = 1\text{ mA}, V_{GS} = 0\text{ V}$	30			V
$\Delta BV_{DSS} / \Delta T_J$	Breakdown Voltage Temperature Coefficient	$I_D = 10\text{ mA}$, referenced to 25°C		33		$\text{mV}/^\circ\text{C}$
I_{DSS}	Zero Gate Voltage Drain Current	$V_{DS} = 24\text{ V}, V_{GS} = 0\text{ V}$			500	μA
I_{GSS}	Gate to Source Leakage Current	$V_{GS} = \pm 20\text{ V}, V_{DS} = 0\text{ V}$			± 100	nA

ON CHARACTERISTICS

$V_{GS(th)}$	Gate to Source Threshold Voltage	$V_{GS} = V_{DS}, I_D = 1\text{ mA}$	1.0	2.1	3.0	V
$\Delta V_{GS(th)} / \Delta T_J$	Gate to Source Threshold Voltage Temperature Coefficient	$I_D = 10\text{ mA}$, referenced to 25°C		-5		$\text{mV}/^\circ\text{C}$
$R_{DS(on)}$	Static Drain to Source On Resistance	$V_{GS} = 10\text{ V}, I_D = 18\text{ A}$		3.8	4.8	m Ω
		$V_{GS} = 4.5\text{ V}, I_D = 15\text{ A}$		5.3	7.0	
		$V_{GS} = 10\text{ V}, I_D = 18\text{ A}, T_J = 125^\circ\text{C}$		5.3	7.8	
g_{FS}	Forward Transconductance	$V_{DS} = 5\text{ V}, I_D = 18\text{ A}$		78		S

DYNAMIC CHARACTERISTICS

C_{iss}	Input Capacitance	$V_{DS} = 15\text{ V}, V_{GS} = 0\text{ V}, f = 1\text{ MHz}$		2005	2670	pF
C_{oss}	Output Capacitance			985	1310	
C_{rss}	Reverse Transfer Capacitance			135	205	
R_g	Gate Resistance	$f = 1\text{ MHz}$		0.6	2.0	Ω

SWITCHING CHARACTERISTICS

$t_{d(on)}$	Turn-On Delay Time	$V_{DD} = 15\text{ V}, I_D = 18\text{ A}, V_{GS} = 10\text{ V}, R_{GEN} = 6\ \Omega$		12	22	ns
t_r	Rise Time			4	10	
$t_{d(off)}$	Turn-Off Delay Time			26	42	
t_f	Fall Time			3	10	

FDS8672S

ELECTRICAL CHARACTERISTICS ($T_J = 25^\circ\text{C}$ Unless Otherwise Noted) (continued)

Symbol	Parameter	Test Conditions	Min	Typ	Max	Unit
SWITCHING CHARACTERISTICS						
Q_g	Total Gate Charge	$V_{GS} = 0\text{ V to }10\text{ V}$		29	41	nC
Q_g	Total Gate Charge	$V_{GS} = 0\text{ V to }5\text{ V}$		15	21	nC
Q_{gs}	Gate to Source Charge			5.5		nC
Q_{gd}	Gate to Drain "Miller" Charge			3.7		nC

DRAIN-SOURCE DIODE CHARACTERISTICS

V_{SD}	Source to Drain Diode Forward Voltage	$V_{GS} = 0\text{ V}, I_S = 18\text{ A}$ $V_{GS} = 0\text{ V}, I_S = 1.8\text{ A}$		0.8 0.4	1.2 0.7	V
t_{rr}	Reverse Recovery Time	$I_F = 18\text{ A}, di/dt = 300\text{ A}/\mu\text{s}$		27	43	ns
Q_{rr}	Reverse Recovery Charge			31	50	nC

Product parametric performance is indicated in the Electrical Characteristics for the listed test conditions, unless otherwise noted. Product performance may not be indicated by the Electrical Characteristics if operated under different conditions.

NOTES:

- $R_{\theta JA}$ is determined with the device mounted on a 1 in² pad 2 oz copper pad on a 1.5 × 1.5 in. board of FR-4 material. $R_{\theta JC}$ is guaranteed by design while $R_{\theta CA}$ is determined by the user's board design.



a. 50°C/W when mounted on a 1in² pad of 2 oz copper.



b. 125°C/W when mounted on a minimum pad.

- Pulse Test: Pulse Width < 300 μs , Duty cycle < 2.0%.
- Starting $T_J = 25^\circ\text{C}$, $L = 3\text{ mH}$, $I_{AS} = 12\text{ A}$, $V_{DD} = 30\text{ V}$, $V_{GS} = 10\text{ V}$.
- Pulse current was measured at 250 μs pulse, refer to Figure x11 Forward Safe Operation Area for detail.

PACKAGE MARKING AND ORDERING INFORMATION

Device Marking	Device	Package	Reel Size	Tape Width	Shipping [†]
FDS8672S	FDS8672S	SOIC8	13"	12 mm	2,500 / Tape & Reel

[†]For information on tape and reel specifications, including part orientation and tape sizes, please refer to our Tape and Reel Packaging Specifications Brochure, BRD8011/D.

TYPICAL CHARACTERISTICS

($T_J = 25^\circ\text{C}$ Unless Otherwise Noted)

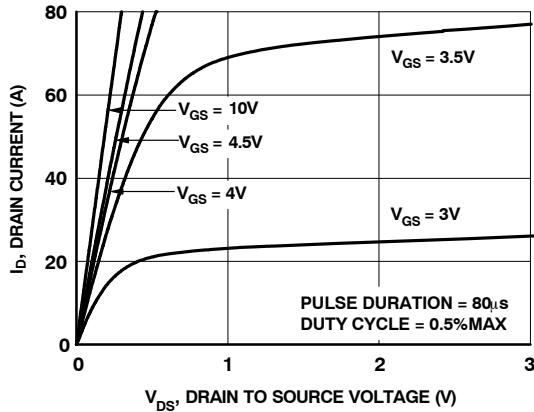

Figure 1. On-Region Characteristics

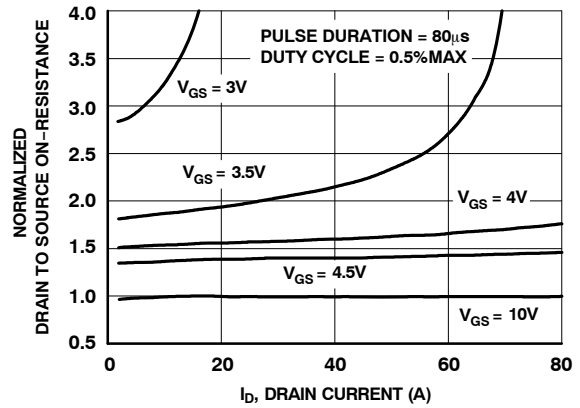

Figure 2. Normalized On-Resistance vs Drain Current and Gate Voltage

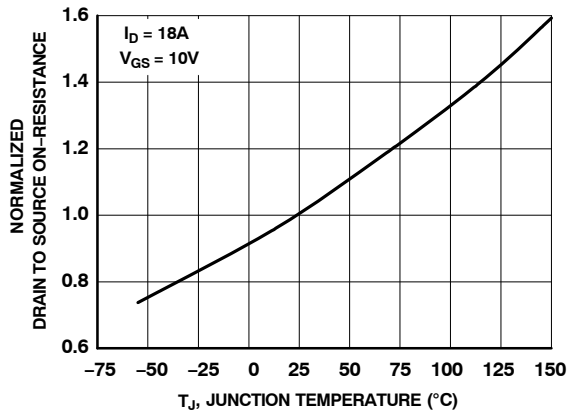

Figure 3. Normalized On Resistance vs Junction Temperature

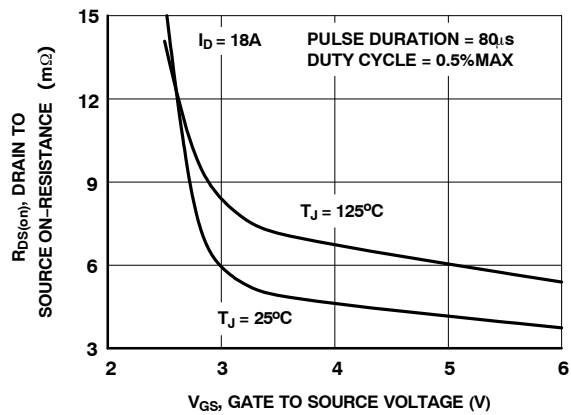

Figure 4. On-Resistance vs Gate to Source Voltage

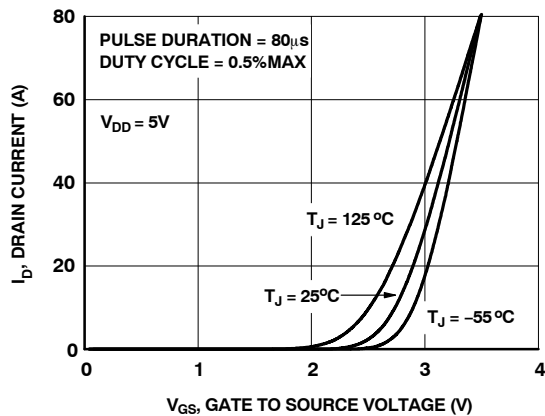

Figure 5. Transfer Characteristics

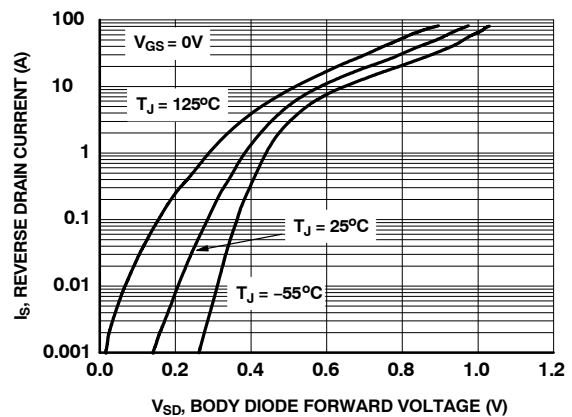

Figure 6. Source to Drain Diode Forward Voltage vs Source Current

TYPICAL CHARACTERISTICS (Continued)

($T_J = 25^\circ\text{C}$ Unless Otherwise Noted)

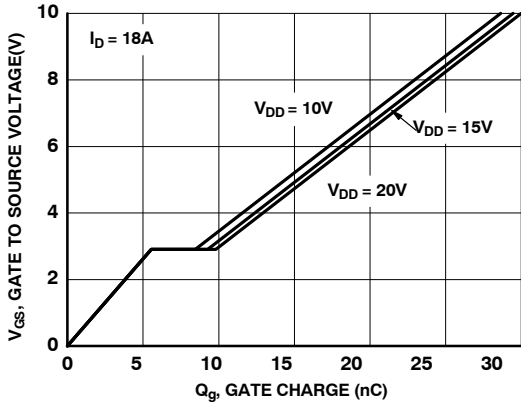

Figure 7. Gate Charge Characteristics

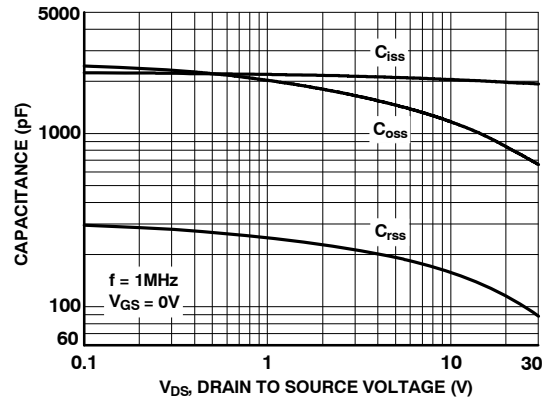

Figure 8. Capacitance vs. Drain to Source Voltage

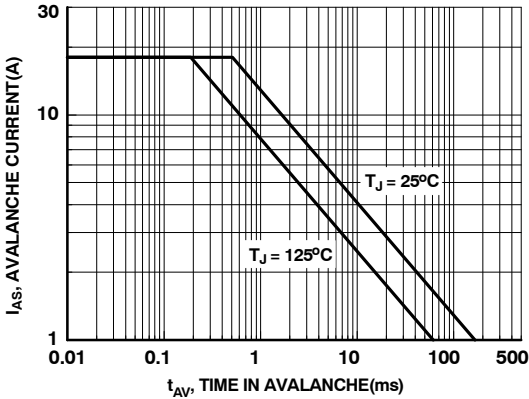

Figure 9. Unclamped Inductive Switching Capability

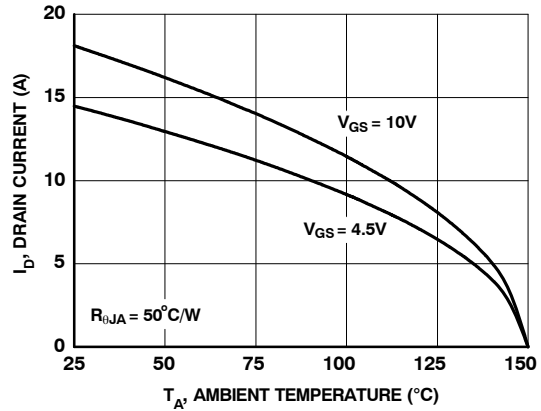

Figure 10. Maximum Continuous Drain Current vs. Ambient Temperature

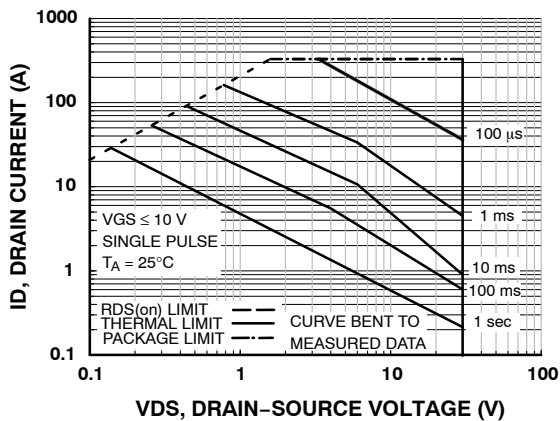

Figure 11. Forward Bias Safe Operating Area

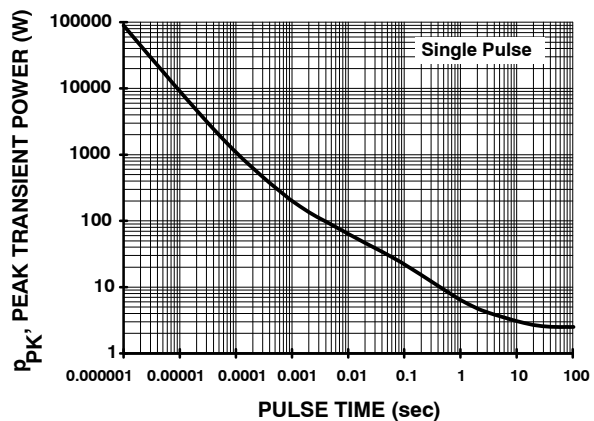

Figure 12. Single Pulse Maximum Power Dissipation

TYPICAL CHARACTERISTICS (Continued)

($T_J = 25^\circ\text{C}$ Unless Otherwise Noted)

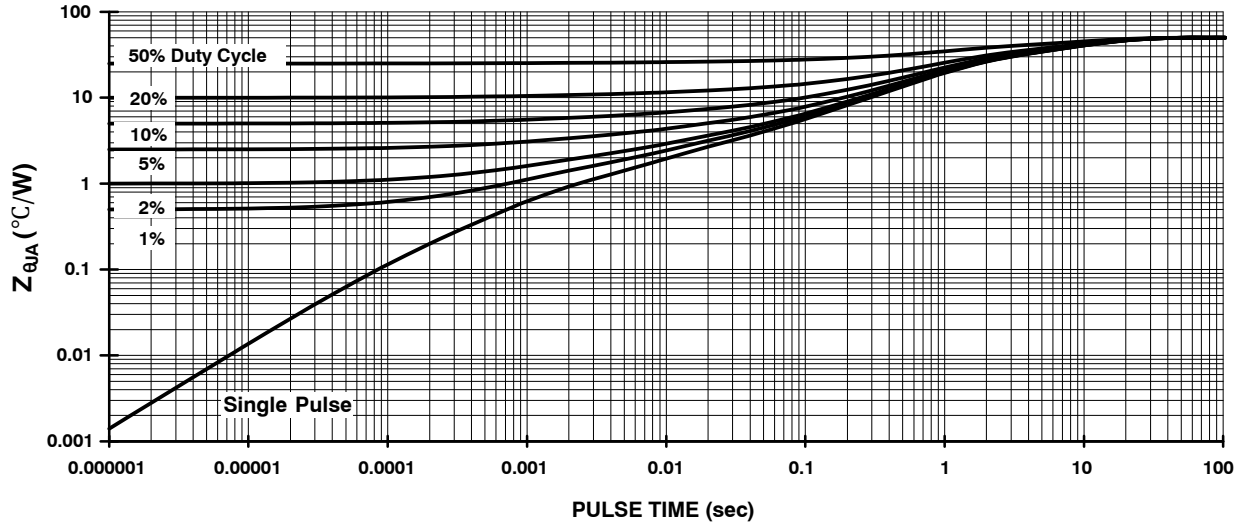

Figure 13. Junction-to-Ambient Transient Thermal Response Curve

SyncFET is trademark of Semiconductor Components Industries, LLC (SCILLC) or its subsidiaries in the United States and/or other countries.
 POWERTRENCH is registered trademark of Semiconductor Components Industries, LLC (SCILLC) or its subsidiaries in the United States and/or other countries.

MECHANICAL CASE OUTLINE
PACKAGE DIMENSIONS

ON Semiconductor®



SOIC8
CASE 751EB
ISSUE A

DATE 24 AUG 2017

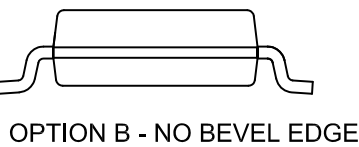
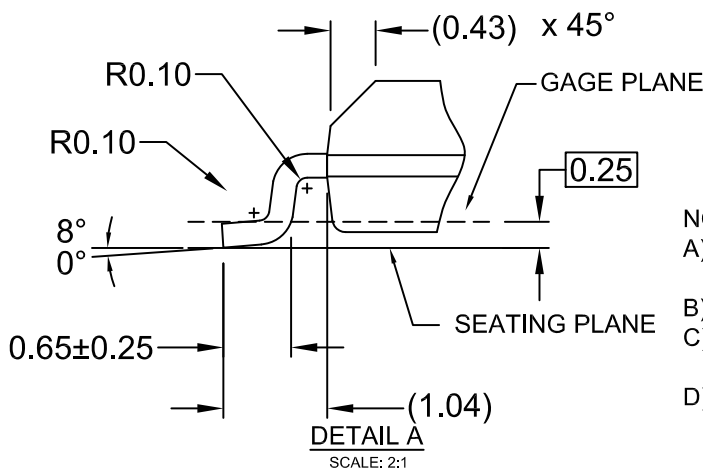
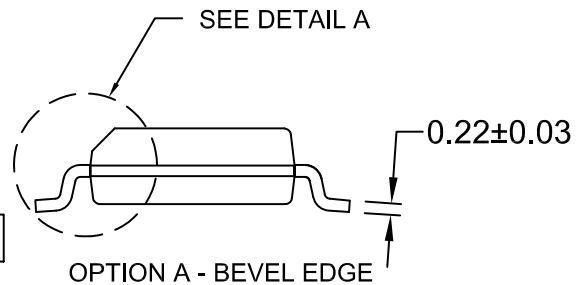
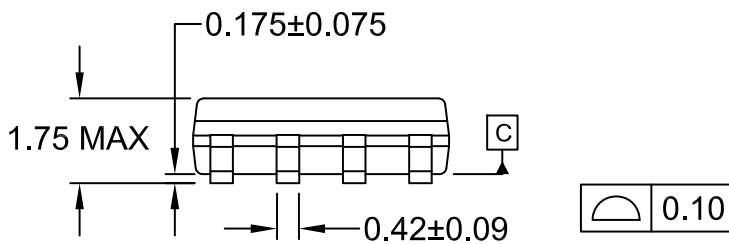
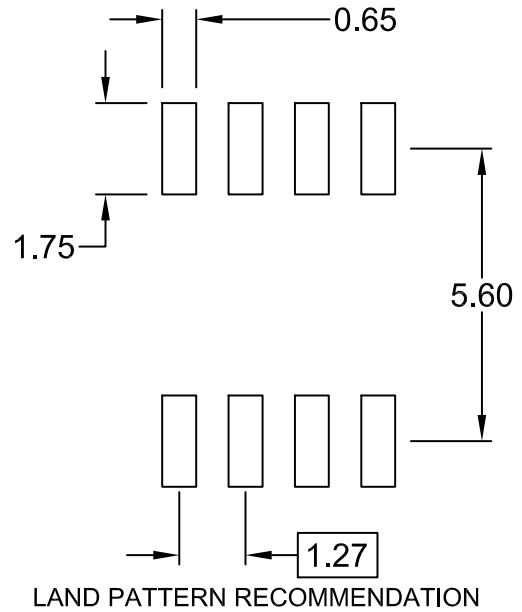
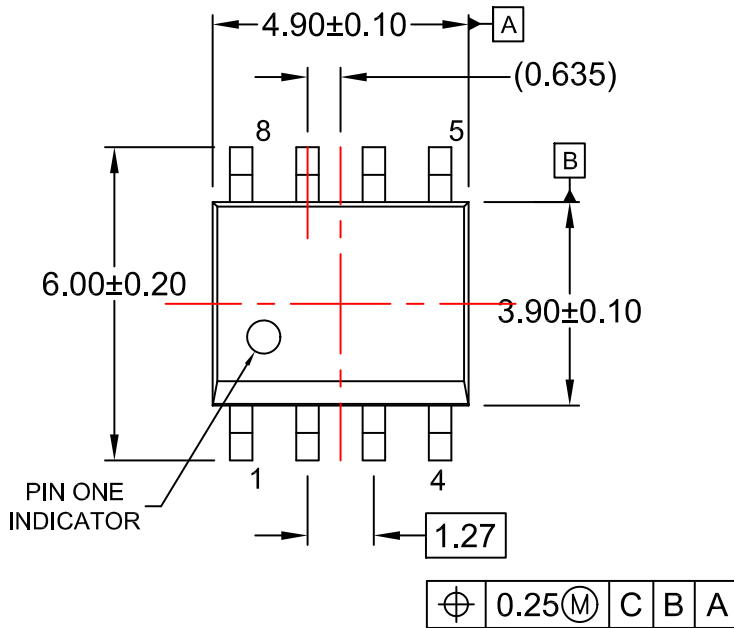

NOTES:

- A) THIS PACKAGE CONFORMS TO JEDEC MS-012, VARIATION AA.
- B) ALL DIMENSIONS ARE IN MILLIMETERS.
- C) DIMENSIONS DO NOT INCLUDE MOLD FLASH OR BURRS.
- D) LANDPATTERN STANDARD: SOIC127P600X175-8M

DOCUMENT NUMBER:	98AON13735G	Electronic versions are uncontrolled except when accessed directly from the Document Repository. Printed versions are uncontrolled except when stamped "CONTROLLED COPY" in red.
DESCRIPTION:	SOIC8	PAGE 1 OF 1

ON Semiconductor and are trademarks of Semiconductor Components Industries, LLC dba ON Semiconductor or its subsidiaries in the United States and/or other countries. ON Semiconductor reserves the right to make changes without further notice to any products herein. ON Semiconductor makes no warranty, representation or guarantee regarding the suitability of its products for any particular purpose, nor does ON Semiconductor assume any liability arising out of the application or use of any product or circuit, and specifically disclaims any and all liability, including without limitation special, consequential or incidental damages. ON Semiconductor does not convey any license under its patent rights nor the rights of others.

onsemi, **Onsemi**, and other names, marks, and brands are registered and/or common law trademarks of Semiconductor Components Industries, LLC dba "**onsemi**" or its affiliates and/or subsidiaries in the United States and/or other countries. **onsemi** owns the rights to a number of patents, trademarks, copyrights, trade secrets, and other intellectual property. A listing of **onsemi**'s product/patent coverage may be accessed at www.onsemi.com/site/pdf/Patent-Marking.pdf. **onsemi** reserves the right to make changes at any time to any products or information herein, without notice. The information herein is provided "as-is" and **onsemi** makes no warranty, representation or guarantee regarding the accuracy of the information, product features, availability, functionality, or suitability of its products for any particular purpose, nor does **onsemi** assume any liability arising out of the application or use of any product or circuit, and specifically disclaims any and all liability, including without limitation special, consequential or incidental damages. Buyer is responsible for its products and applications using **onsemi** products, including compliance with all laws, regulations and safety requirements or standards, regardless of any support or applications information provided by **onsemi**. "Typical" parameters which may be provided in **onsemi** data sheets and/or specifications can and do vary in different applications and actual performance may vary over time. All operating parameters, including "Typicals" must be validated for each customer application by customer's technical experts. **onsemi** does not convey any license under any of its intellectual property rights nor the rights of others. **onsemi** products are not designed, intended, or authorized for use as a critical component in life support systems or any FDA Class 3 medical devices or medical devices with a same or similar classification in a foreign jurisdiction or any devices intended for implantation in the human body. Should Buyer purchase or use **onsemi** products for any such unintended or unauthorized application, Buyer shall indemnify and hold **onsemi** and its officers, employees, subsidiaries, affiliates, and distributors harmless against all claims, costs, damages, and expenses, and reasonable attorney fees arising out of, directly or indirectly, any claim of personal injury or death associated with such unintended or unauthorized use, even if such claim alleges that **onsemi** was negligent regarding the design or manufacture of the part. **onsemi** is an Equal Opportunity/Affirmative Action Employer. This literature is subject to all applicable copyright laws and is not for resale in any manner.

ADDITIONAL INFORMATION

TECHNICAL PUBLICATIONS:

Technical Library: www.onsemi.com/design/resources/technical-documentation
onsemi Website: www.onsemi.com

ONLINE SUPPORT: www.onsemi.com/support

For additional information, please contact your local Sales Representative at www.onsemi.com/support/sales