

206061-1 ✓ ACTIVE

AMP | AMP CPC

TE Internal #: 206061-1

Circular Power Connectors, Housing, 600 VDC, Wire-to-Wire, 4 Position, Wire & Cable, Receptacle, Pin, Power & Signal, Black, All Plastic, AMP CPC

[View on TE.com >](#)



Connectors > Power Connectors > Circular Power > Circular Power Connectors > Cable/Panel Mount Connector, CPC Series 1



Connector Product Type: **Housing**

Operating Voltage: **600 VDC**

Connector System: **Wire-to-Wire**

Number of Positions: **4**

Sealable: **No**

[All Cable/Panel Mount Connector, CPC Series 1 \(57\)](#)

## Features

### Product Type Features

Connector Product Type	Housing
Connector System	Wire-to-Wire
Sealable	No
Connector & Contact Terminates To	Wire & Cable
Connector & Housing Type	Receptacle
Circular Connector Shell Type	All Plastic

### Configuration Features

Reverse Numbering	Without
Number of Positions	4
Number of Power Positions	0
Number of Signal Positions	4

### Electrical Characteristics



Operating Voltage	600 VAC
-------------------	---------

### Contact Features

Reverse Gender	No
----------------	----

Contact Type	Pin
--------------	-----

Contact Protection	With
--------------------	------

### Mechanical Attachment

Mating Alignment Type	Keyed
-----------------------	-------

Mating Alignment	With
------------------	------

Panel Mount Feature Type	Flange with Mounting Holes
--------------------------	----------------------------

Mating Retention Type	Threaded Coupling
-----------------------	-------------------

Thread Size	5/8-24 UNEF-2A
-------------	----------------

Polarization Code	A
-------------------	---

Connector Mounting Type	Panel Mount
-------------------------	-------------

Mating Retention	With
------------------	------

Panel Mount Feature	With
---------------------	------

### Housing Features

Body Orientation	Straight
------------------	----------

Housing Color	Black
---------------	-------

Housing Material	Thermoplastic
------------------	---------------

Circular Connector Shell Size	11
-------------------------------	----

### Usage Conditions

Operating Temperature Range	-55 - 105 °C[-67 - 221 °F]
-----------------------------	----------------------------

Fluid Resistance	None
------------------	------

### Operation/Application

Circuit Application	Power & Signal
---------------------	----------------

Shielded	No
----------	----

### Industry Standards

UL Flammability Rating	UL 94V-0
------------------------	----------

### Packaging Features

Packaging Quantity	1
--------------------	---

Packaging Method	Standard
------------------	----------



## Product Compliance









[For compliance documentation, visit the product page on TE.com>](#)

EU RoHS Directive 2011/65/EU	Compliant
EU ELV Directive 2000/53/EC	Compliant
China RoHS 2 Directive MIIT Order No 32, 2016	No Restricted Materials Above Threshold
EU REACH Regulation (EC) No. 1907/2006	Current ECHA Candidate List: JAN 2024 (240) Candidate List Declared Against: JAN 2024 (240) Does not contain REACH SVHC
Halogen Content	BFR/CFR/PVC Free, but Br/Cl >900 ppm in other sources.
Solder Process Capability	Not applicable for solder process capability

### Product Compliance Disclaimer

This information is provided based on reasonable inquiry of our suppliers and represents our current actual knowledge based on the information they provided. This information is subject to change. The part numbers that TE has identified as EU RoHS compliant have a maximum concentration of 0.1% by weight in homogenous materials for lead, hexavalent chromium, mercury, PBB, PBDE, DBP, BBP, DEHP, DIBP, and 0.01% for cadmium, or qualify for an exemption to these limits as defined in the Annexes of Directive 2011/65/EU (RoHS2). Finished electrical and electronic equipment products will be CE marked as required by Directive 2011/65/EU. Components may not be CE marked. Additionally, the part numbers that TE has identified as EU ELV compliant have a maximum concentration of 0.1% by weight in homogenous materials for lead, hexavalent chromium, and mercury, and 0.01% for cadmium, or qualify for an exemption to these limits as defined in the Annexes of Directive 2000/53/EC (ELV). Regarding the REACH Regulation, the information TE provides on SVHC in articles for this part number is based on the latest European Chemicals Agency (ECHA) 'Guidance on requirements for substances in articles' posted at this URL: <https://echa.europa.eu/guidance-documents/guidance-on-reach>

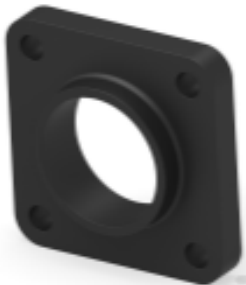
## Compatible Parts

 <p>TE Part # CAT-AM71-C83998B CPC Cable Clamps</p>	 <p>TE Part # CAT-AM71-C83998K Circular Connector, Environmentally Sealed, CPC Series 6</p>	 <p>TE Part # 207489-1 FLEXIBLE CABLE BOOT, SIZE 11</p>	 <p>TE Part # 207490-1 CABLE GRIPPER, SIZE 11</p>
 <p>TE Part # 206061-3 CPC RECP,SZ 11-4,SMALL PACK</p>	 <p>TE Part # 213811-1 COUPLING RING,SZ 11,CPC</p>	 <p>TE Part # 207299-1 PLUG MTG. FLANGE NO 11 CPC</p>	 <p>TE Part # 1-2407269-2 CAP, CPC, SIZE 11 RECP &amp; 13 PLUG, BLACK</p>

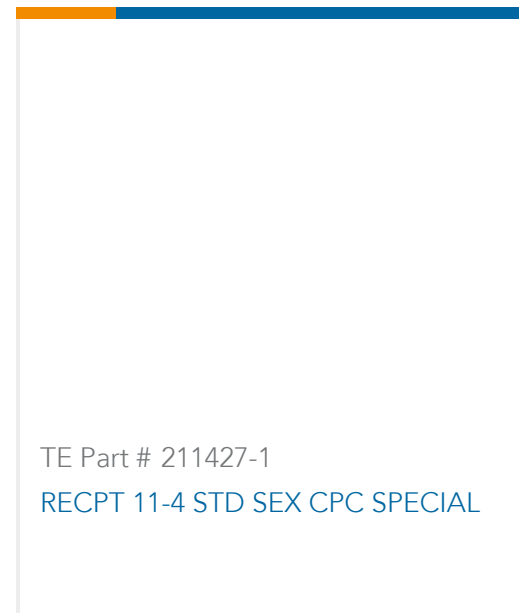

Also in the Series | AMP CPC

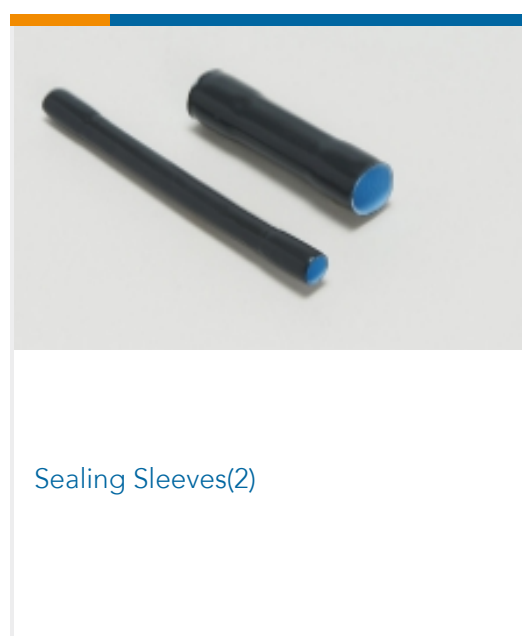
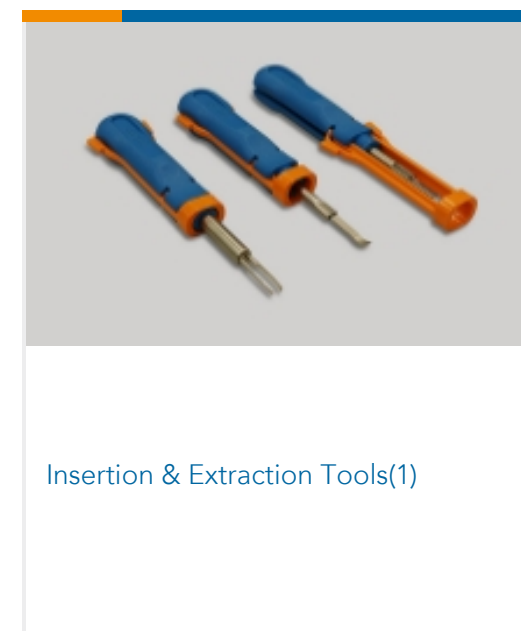
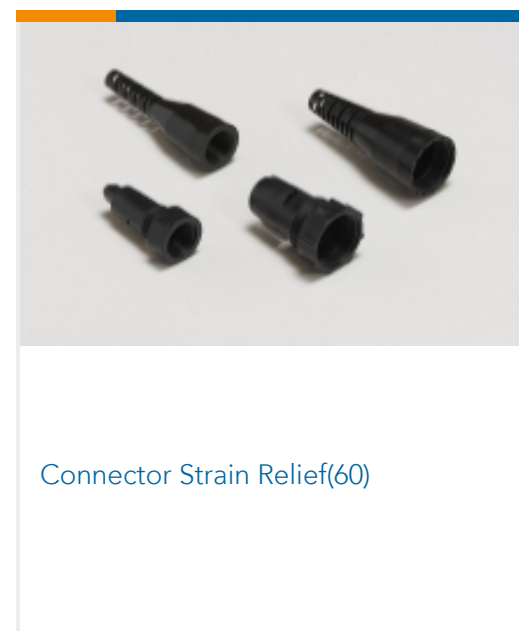
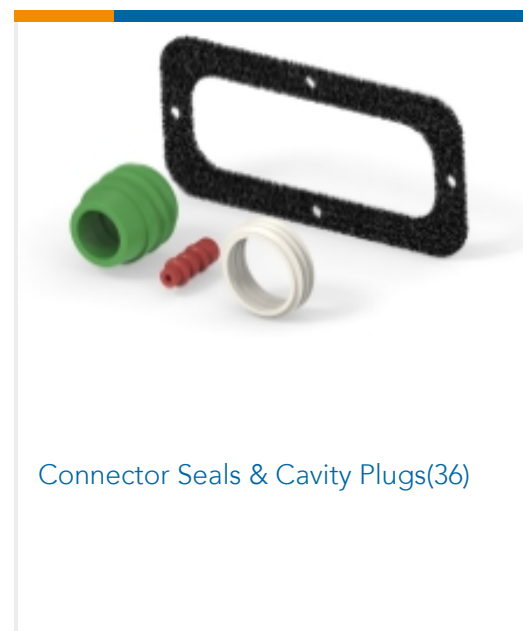
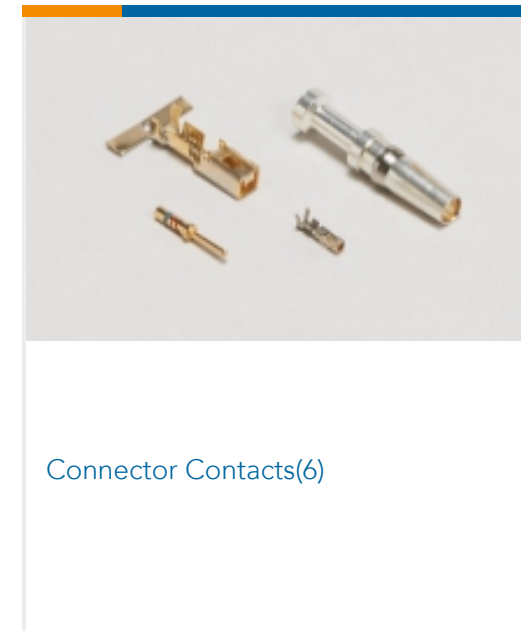
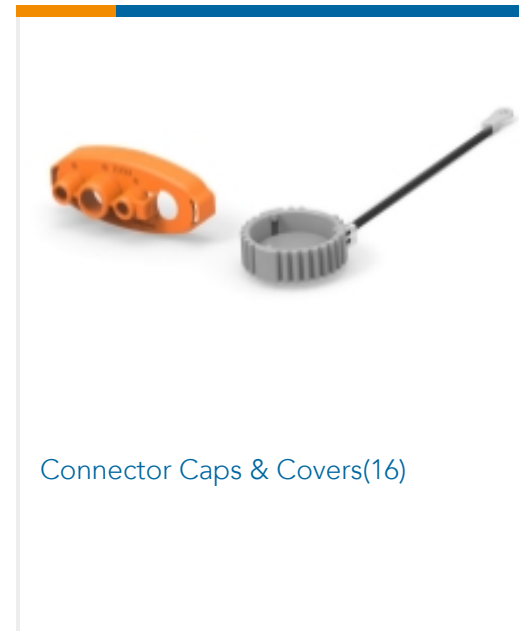
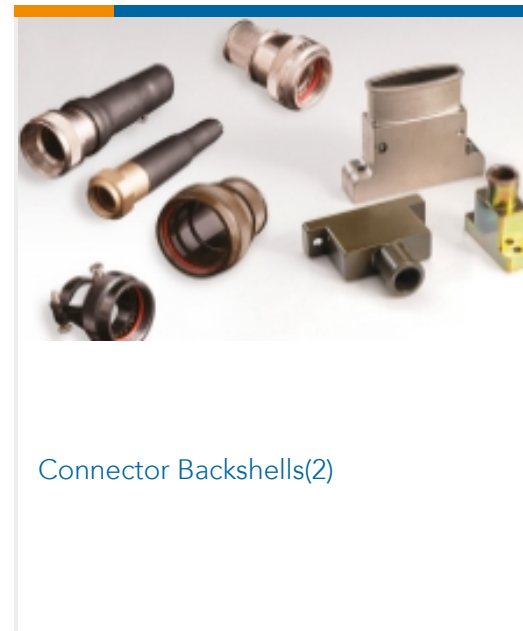
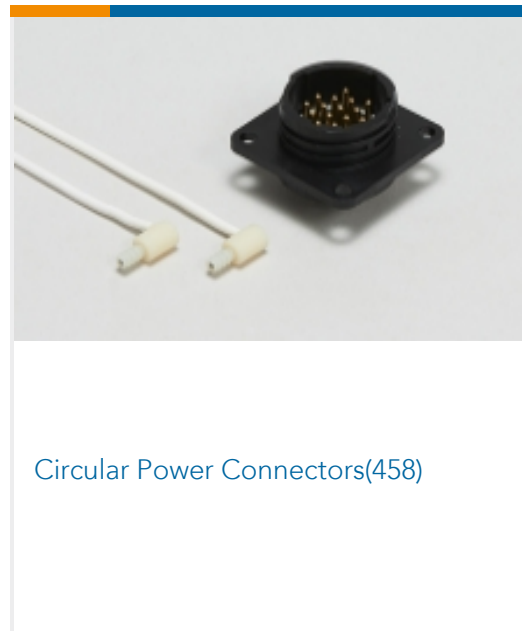

Customers Also Bought



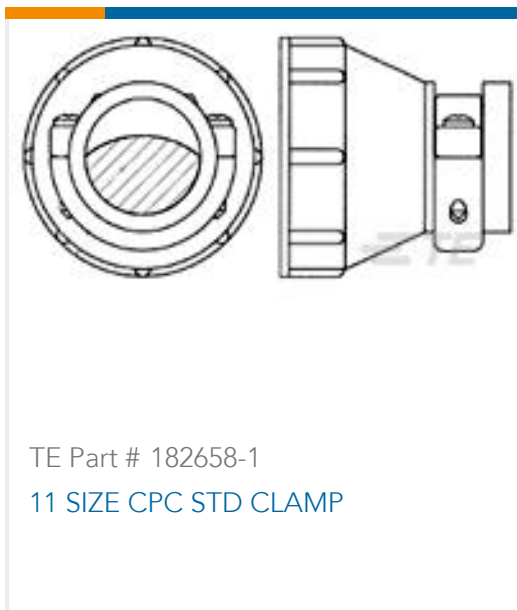

## Documents

### Product Drawings

[RECPT, SZ 11-4, CPC](#)

English

### CAD Files

[3D PDF](#)

3D

Customer View Model

[ENG\\_CVM\\_CVM\\_206061-1\\_AD.2d\\_dxf.zip](#)

English

Customer View Model

[ENG\\_CVM\\_CVM\\_206061-1\\_AD.3d\\_igs.zip](#)

English

Customer View Model

[ENG\\_CVM\\_CVM\\_206061-1\\_AD.3d\\_stp.zip](#)

English

By downloading the CAD file I accept and agree to the [Terms and Conditions](#) of use.

### Datasheets & Catalog Pages

[AMP Circular Connectors for Commercial Signal & Power Applications](#)

English

### Product Specifications

[Application Specification](#)

English

### Instruction Sheets

[Instruction Sheet \(U.S.\)](#)

English

### Agency Approvals

[UL Report](#)

English